



# DT1 - DT1AM DUAL TECHNOLOGY SENSOR



## 1. INTRODUCTION

**ProLine detectors** represent the best choice for residential and industrial installations in the security sector.

It uses only digital PIRs, thus avoiding the conversion that generally must be done in traditional detectors, where the analog PIR is amplified and converted to digital. Thanks to the TOTALLY digital technology, the detector is much more accurate in detecting intrusions and not suffering of alterations such as: white light, ultraviolet light, temperature, air movement due to heating/cooling systems and it is totally immune to radiated and conducted electromagnetic disturbances. ProLine detectors are equipped with lenses designed by AMC and made by Fresnel Technologies, Inc.

**LODIFF®** technology for optics realization in combination with **POLY IR®** materials make it a product with highest quality and efficiency.

All ProLine detectors are pet immune with range of 15 mt, with 100 degrees angle.

The sensor is equipped with latest generation microwave modules, with very low background noise, and can be supplied with different frequencies in compliance with the legislation of the individual countries.



### White light protection

The detector is digitally filtered from white light.

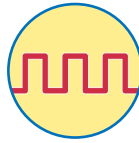

### Full digital PIR

The detector has no analog components, the full digital PIR is connected directly to the microprocessor.



### High RFI protection

Thanks to the total lack of traditional amplifiers, the detector has a very high RFI immunity.



### Pet immunity

All our detectors are pet immune up to 15 Kg, thanks to the new lens design combined with the digital analysis system.



### Ultraviolet stabilization POLY IR®4 material for lenses

The lens materials is POLY IR®. It offers the best combination of transmittance, environmental stability, and color of any polymer. Materials available for the 8-14 micron region of the infrared.

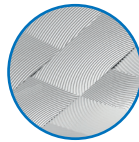

### LODIFF® Fresnel Lens Technology

The lens array is made by tiling pieces of LODIFF® lenses. These lenses offer significantly improved performance over typical constant-groove-width Fresnel.

## 2. INSTALLATION PROCEDURE

- By using a thin screwdriver, loosen the screw on the bottom and open the housing.
- Remove the PCB from the base by levering on the ABS supports.
- Pierce the knock on the base of cover on the desired point for fixing (or use the optional swivel bracket not certified IMQ)
- Pierce the knock on the base and fix a screw between wall and cover for back tamper protection.
- recommended height from 1.8mt to 2,2mt
- slide the cable into the back seat, and out of the top hole
- NOTE: the pet immune function is not certified IMQ

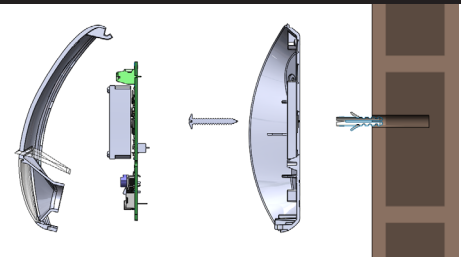

## 3. LED FUNCTIONS

During normal operation:

- GREEN LED: PIR Alarm
- YELLOW LED: MW Alarm
- BLUE LED: General Alarm (PIR and MW)
- **AM VERSION:** in case of masking, the LED corresponding to the masked technology flashes with the opening the alarm contacts with MASK contact

### AM version (antimasking version)

The AM version provides a continuous self test, in case of anomaly lasting more than 15 seconds the sensor will report the following signaling:

- **POWER SUPPLY BEYOND THE NOMINAL THRESHOLDS :**  
Alternative flashing of yellow and green led with Mask contact opened
- **PIR FILED SELF-TEST**  
green led flashing with opened MASK contact
- **MW filed SELF-TEST**  
Yellow led flashing with opened MASK contact

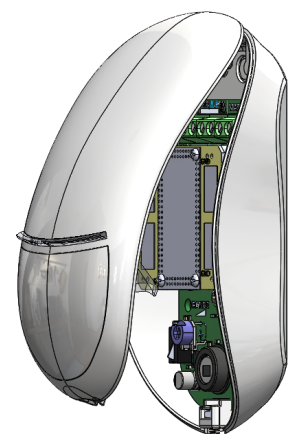

## 3. ADJUSTMENTS AND CONNECTION

- Dip 1 --> off = led off - on = led on\*
- Dip 2 --> off = 15mt - on = 7mt range
- Dip 3 --> off = 1 pulse - on = 2 pulse
- Dip 4 - 5 --> OFF-OFF = AND ON-OFF=OR ON-ON=AUTO OR\*
- Trimmer Range = used only for MW
- Jumpers T - A - EOL open = all contact Free without resistors

\*remote walk test led control only DT1AM: connect a 39 Ohm R in series to the positive supply, connect the NC output in parallel to R (see figure). The out must have 3/4 sec. pulse. The led can be activated and deactivated at each pulse. for each sensor connected add an R in parallel to the first one, and connect the power supplies in common.

- Jumpers T - A - EOL closed = double balancing (alarm2k2 - tamper 4K7)
- Tamper terminals (use EOL terminal tamper when the jumpers closed)
- ALARM terminals (use EOL terminal alarm when the jumpers closed)
- DT1 = SUPPLY: power supply 9 - 15Vcc @ 18 mA nominal
- DT1AM = SUPPLY: power supply 9 - 15Vcc @ 27 mA nominal
- MASK: masking tamper terminal (only for AM version)

**Internal EOL jumper closed**  
**Resistenze interne jumper chiusi**  
**2k2 + 4k7**

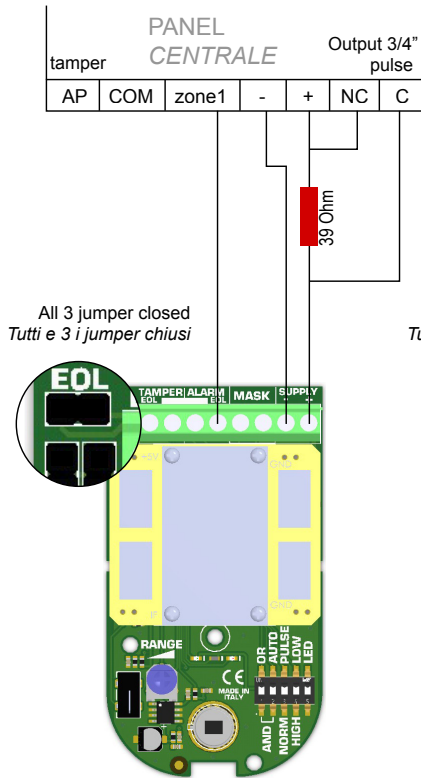

**External EOL jumper opened**  
**Resistenze esterne jumper aperti**

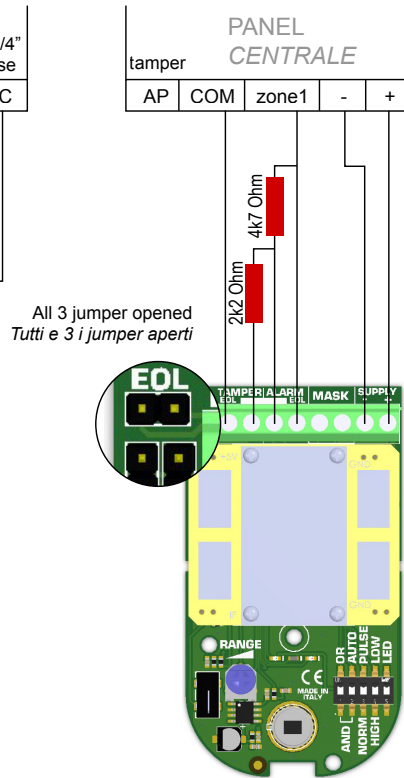

**NC jumper opened**  
**NC jumper aperti**

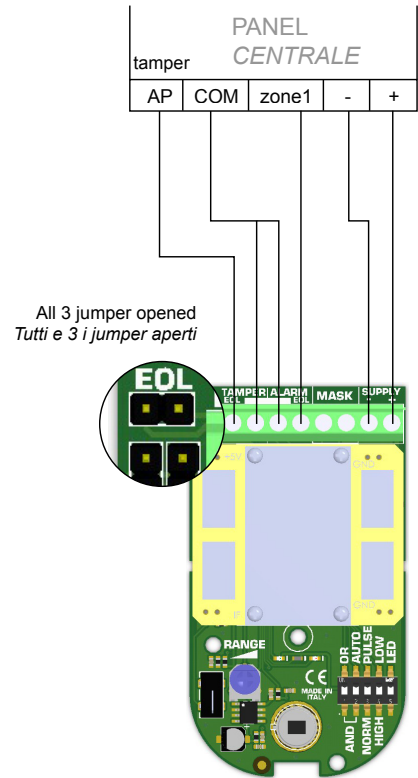

### Technical Features

### DT1

DUAL TECHNOLOGY

RANGE	15 mt
ANGLE	100°
LENS	Fresnel Lens LODIFF® POLY IR®4 material
LED	green, yellow, blue
ALARM TIME	2"
SELF TEST	-
WALK TEST'S LED	YES
MICROWAVE FREQUENCY	9.3 - 9.9 - 10.5 Ghz
SOLID STATE RELAY	YES
INTERNAL EOL RESISTORS	YES
CREEP ZONE	YES
ANTI-OPENING TAMPER	YES
BACK TAMPER	YES
ANTI-MASKING DEVICE	-
PULSE COUNTER	YES
RFI PROTECTION	30 V/m
TEMPERATURE COMPENSATION	YES
FULL DIGITAL	YES
BRACKET AVAILABLE	YES
POWER SUPPLY	13.8 Vdc
HOUSING	ABS
PET IMMUNITY	YES
OPERATING TEMPERATURE	from -10°C to +40°C
DIMENSIONS	114 x 63 x 40 mm

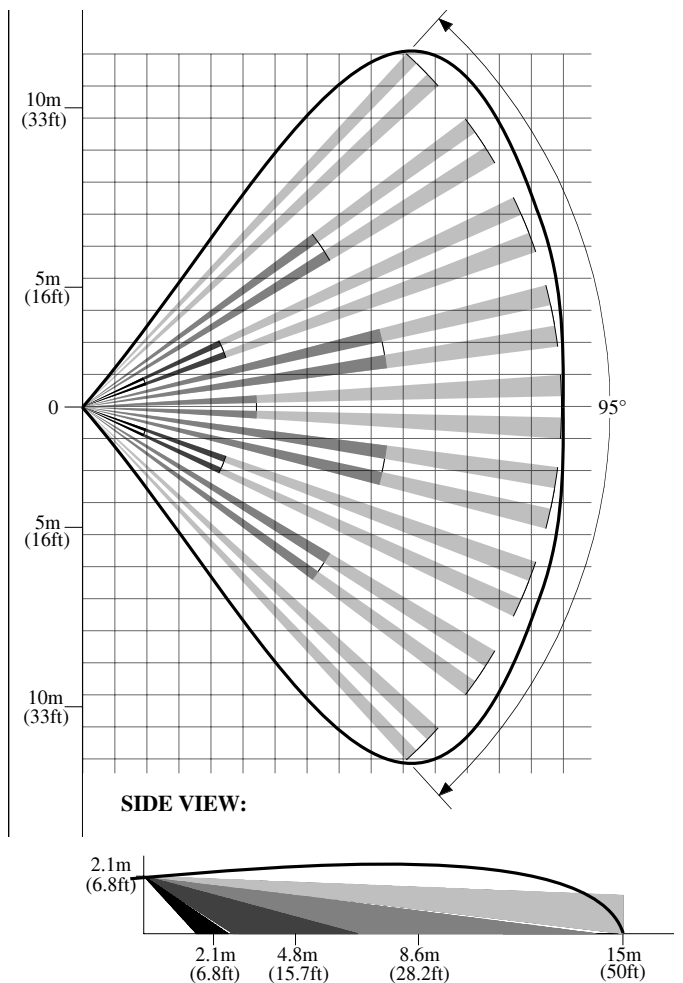

**Meets the requirements: EN 50131-2-4 Grade 2 (Grade 3 for AM version) EN 50131-2-4 Class II**  
**Cumple los requisitos: EN 50131-2-4 Grado 2 (Grade 3 for AM version) EN 50131-2-4 Class II**

Installation must be carried out following the local installation norms by qualified personnel.

The manufacturer refuses any responsibility when changes or unauthorized repairs are made to the product/system.

It is recommended to test the operation of the alarm product/system at least once a month. Despite frequent testing and due to, but not limited to, any or all of the following: tampering, electrical or communication disruption or improper use, it is possible for the product/system to fail to prevent burglary, robbery, fire or otherwise. A properly installed and maintained alarm system can only reduce the risk that this happens.



# DT1 - DT1AM SENSORE DOPPIA TECNOLOGIA



## 1. INTRODUZIONE

La nuova gamma di sensori **ProLine** rappresenta la miglior scelta per le installazioni di tipo residenziale ed industriale nel settore della sicurezza. I sensori ProLine utilizzano solo PIR di tipo digitale, evitando così la conversione che generalmente deve essere fatta nei sensori tradizionali, dove il PIR analogico è amplificato e convertito successivamente in digitale. Grazie alla tecnologia TOTALMENTE digitale, il sensore risulta molto più preciso nella rilevazione delle intrusioni, non subendo alterazioni quali: luce bianca, ultravioletta, temperatura, spostamenti d'aria dovuti ad impianti riscaldamento/raffreddamento. Inoltre è totalmente immune da disturbi elettromagnetici irradiati e condotti. I sensori ProLine sono equipaggiati da una lente disegnata da AMC Elettronica e realizzata da Fresnel Technologies, Inc. La tecnologia **LODIFF®** per la realizzazione delle ottiche in combinazione con i materiali **POLY IR®** ne fanno un prodotto di altissima qualità ed efficienza. Tutti i sensori ProLine sono pet immune ed hanno unrange di 15 m, con apertura fino a 100 gradi.



### Protezione da luce bianca

Il sensore è filtrato digitalmente dalla componente bianca della luce.



### Alta protezione RFI

Grazie alla totale mancanza di amplificatori tradizionali, il sensore ha un'immunità RFI molto elevata.

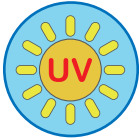

### materiale plastico POLY IR®4 per la stabilità della rilevazione

Materiali lenti POLY IR®. Questi materiali offrono una migliore combinazione di trasmittanza, stabilità ambientale e colore di qualsiasi polimero in commercio. Materiali disponibili per la regione 8-14 micron dell'infrarosso. LODIFF® e POLY IR® sono marchi registrati di Fresnel Technologies, Inc.

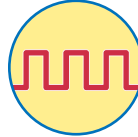

### PIR totalmente digitale

Il sensore non ha componenti analogici, il PIR completamente digitale si interfaccia direttamente al microprocessore.



### Pet immunity

Tutti i nostri sensori sono pet immune fino a 15 kg, grazie ad un nuovo design della lente unito al sistema di analisi digitale.

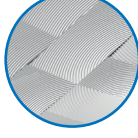

### Lenti LODIFF® Fresnel Technology

a serie di lenti è costituita dalla piastrellatura di pezzi di lenti LODIFF®. Queste lenti offrono prestazioni significativamente migliorate rispetto alla tipica lente Fresnel a larghezza di banda costante.

LODIFF® e POLY IR® sono marchi registrati di Fresnel Technologies, Inc.

## 2. INSTALLATIONE

- Svitare la vite sul fondo del sensore senza rimuoverla e aprire la scocca superiore ( figura 1)
- rimuovere la scheda dal fondo plastico svitando la vite sulla scheda ( figura 2)
- aprire gli sfondabili che necessitano per il fissaggio a muro (oppure usare lo snodo non certificato IMQ)
- aprire lo sfondabile per la protezione antirimozione e fissare il tassello al muro (fig)
- Altezza raccomandata 2mt
- far passare i cavi di collegamento sul fondo del contenitore ed uscire dalla parte alta
- collegare i cavi sulla scheda come da descrizione successiva

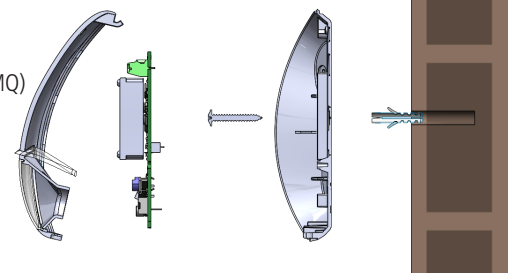

## 3. SIGNIFICATO DEI LED

Durante il funzionamento normale le segnalazioni dei led sono:

LED VERDE: allarme proveniente dall'infrarosso

LED GIALLO: allarme proveniente dalla microonda

LED BLU: allarme proveniente da entrambe le tecnologie

**VERSIONE AM:** in caso di accensione lampeggia il led corrispondente alla tecnologia mascherata, con apertura dei contatti di allarme e di MASK

### VERSIONE AM (antimascheramento)

La versione AM prevede un self test continuo sul sensore, in caso di anomalia con durata oltre ai 15 secondi il sensore segnalerà:

### TENSIONE DI ALIMENTAZIONE OLTRE LE SOGLIE NOMINALI:

Lampeggio alternato dei Led GIALLO e VERDE e apertura del contatto MASK

### FALLIMENTO SELF-TEST INFRAROSSO

Lampeggio del led verde ed apertura del contatto MASK

### FALLIMENTO SELF-TEST MICROONDA

Lampeggio del led giallo ed apertura del contatto MASK

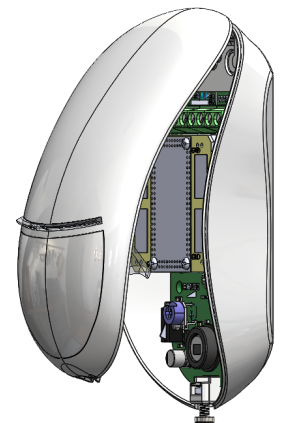

## 4. DIP E CABLAGGIO

Dip 1 --> off = led off - on = led on

Dip 2 --> off = 7mt - on = 15mt range

Dip 3 --> off = 1 pulse - on = 2 pulse

Dip 4 - 5 --> OFF-OFF = AND ON-OFF=OR ON-ON=AUTO OR\*

Trimmer Range = usato solo per la Microonda

Per avere il comando remoto del LED di walk test: collegare in serie al positivo una R da 39 Ohm, collegare in parallelo l'uscita NC la R (vedi figura). L'uscita deve avere 3/4 sec. di impulso. Il led può essere attivato e disattivato ad ogni impulso. per ogni sensore collegato aggiungere una R in parallelo al primo, e collegare in comune le alimentazioni.

Jumpers T - A - EOL aperti = contatti NC senza resistenze

Jumpers T - A - EOL chiusi = doppio bilanciamento (allarm2k2 - tamper 4K7)

DT1AM = Alimentazione = 9 - 15Vcc @ 18 mA nominali

DT1 = Alimentazione = 9 - 15Vcc @ 27 mA nominali

morsetti MASK = Utilizzati per la versione AM (antimascheramento)

**Internal EOL jumper closed**  
**Resistenze interne jumper chiusi**  
**2k2 + 4k7**

**External EOL jumper opened**  
**Resistenze esterne jumper aperti**

**NC jumper opened**  
**NC jumper aperti**

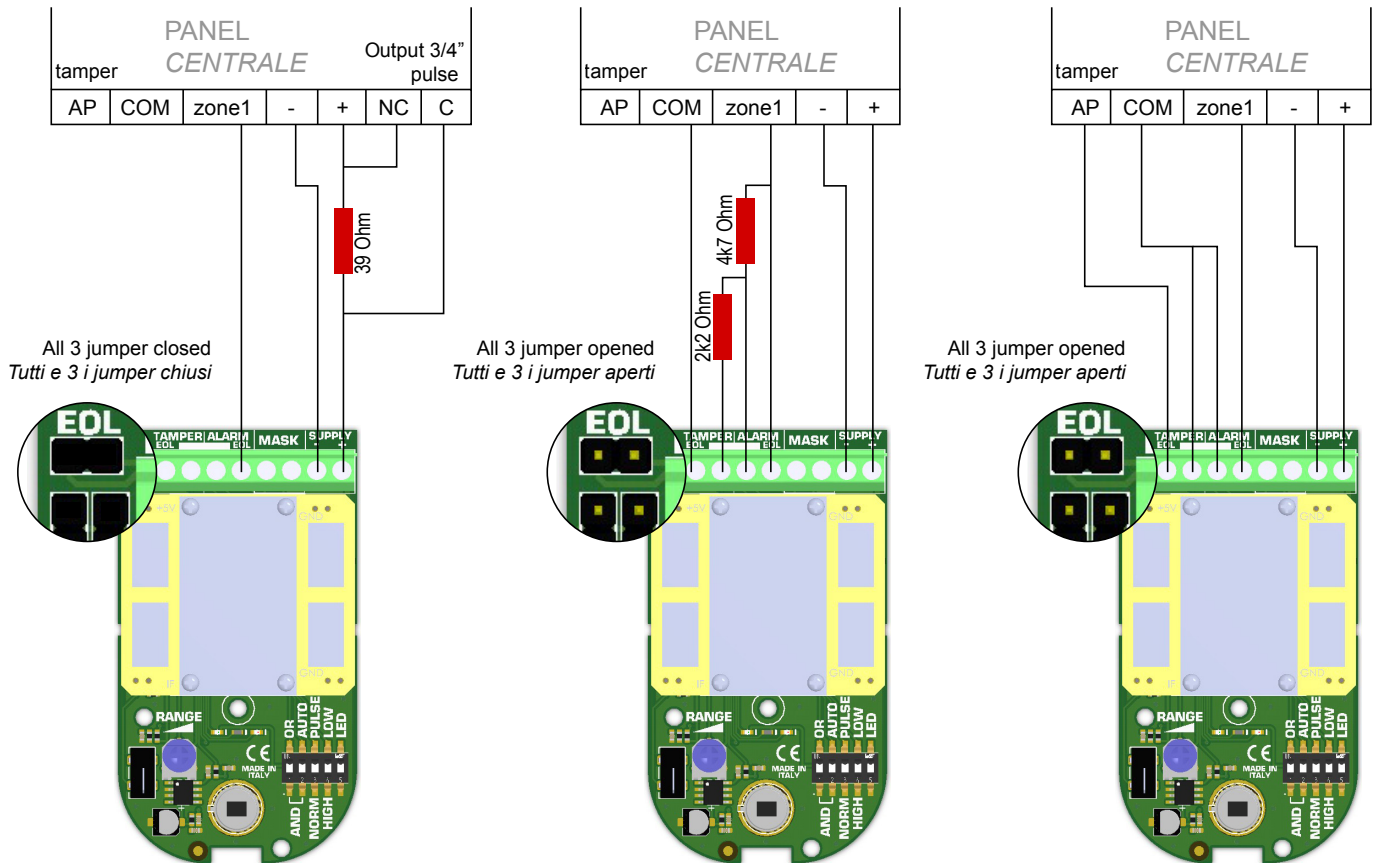

**Technical Features**

**DT1**

DUAL TECHNOLOGY

PORTATA	15 mt
ANGOLO	100°
LENTE	Fresnel Lens LODIFF® POLY IR®4 material
LED	green, yellow, blue
TEMPO ALLARME	2"
SELF TEST	-
WALK TEST'S LED	SI
MW FREQUENZE	9.3 - 9.9 - 10.5 Ghz
SOLID STATE RELÉ'	SI
EOL RESISTENZE BILANCIAMENTO	SI
ANTISTRISCIAMENTO	SI
TAMPER ANTIAPERTURA	SI
TAMPER ANTISTRAPPO	SI
ANTIMASCHERAMENTO	VERSIONE AM
DOPPIO IMPULSO	SI
RFI PROTECTION	30 V/m
COMPENSAZIONE TERMICA	SI
FULL DIGITAL	SI
SNODO	SI
ALIMENTAZIONE	13.8 Vdc
INVOLUCRO	ABS
PET IMMUNITY	SI
TEMPERATURE OPERATIVE	from -10°C to +40°C
DIMENSIONI	114 x 63 x 40 mm

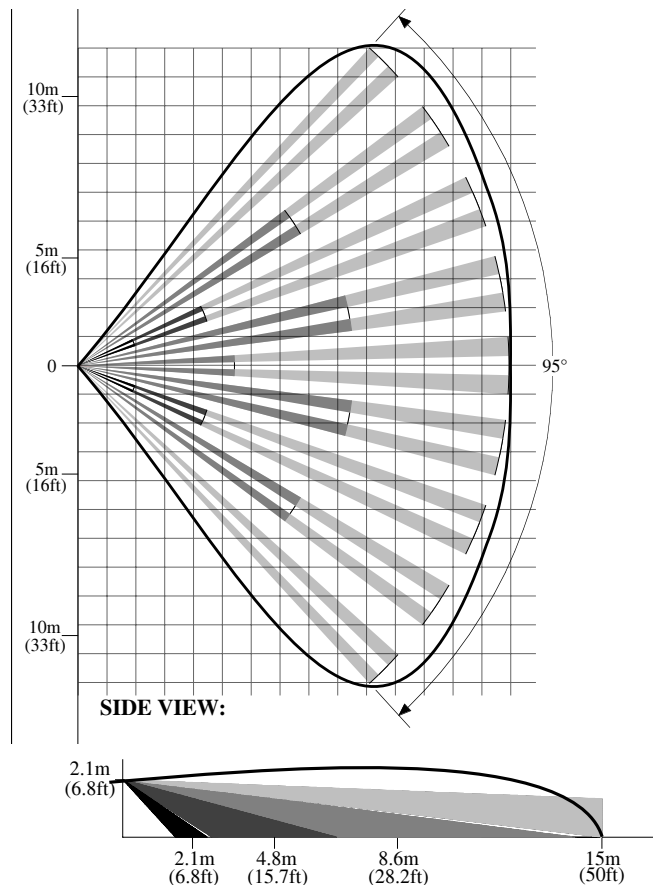

**Meets the requirements: EN 50131-2-4 Grade 2 (grade 3 for AM version) EN 50131-2-4 Class 2**  
**Cumple los requisitos: EN 50131-2-4 Grado 2 (grade 3 for AM version) EN 50131-2-4 Clase 2**

L'installazione deve essere eseguita a regola d'arte da personale specializzato.

Il produttore declina ogni responsabilità nel caso in cui il prodotto venga manomesso da persone non autorizzate.