

PASSIVE INFRARED DETECTOR

CX-702RS , CX-702S

BATTERY OPERATED (CE)

Form C Relay



FEATURES

- Selectable "WIDE ANGLE" and "LONG RANGE" detection patterns.
- Double Conductive Shielding of the pyroelectric element - Extremely High Light.
- Multifocus Optics Design (Patent listed)
- Sealed Optics
- Easy Installation

CX-702RS Only

- Low Current Draw : 5 μ A (Normal. In Standby)
- Battery Operated
- Form C Alarm Output and Tamper Switch

CX-702S Only

- Form C Alarm Output Relay
- LED On/Off Switch

OPTION

- CA-1W : Wall Mount Bracket ; Adjustable $\pm 45^\circ$ (Horizontally), 0-20 $^\circ$ (Vertically downwards)
- CA-2C : Ceiling Bracket ; Adjustable $\pm 45^\circ$ (Horizontally), 0-20 $^\circ$ (Vertically downwards)
- BA-70 : Backbox for wireless transmitter

1. INSTALLATION HINTS

1

Avoid direct sunlight.

2

Avoid mounting detector where movement of Fans or Air Conditioning Fans can be detected.

3

Avoid vapor or high humidity that can cause condensation.

4

Avoid blocking detection area with curtain, screen, etc.

5

Do not install in the outdoors.

6

⚠ WARNING

Never repair or modify product. It may cause accident, fire hazard or electric shock.

7

⚠ WARNING

When damage has occurred to the product, i.e. water logged, abnormal things inside product, overheating or smoking, strange smells etc., immediately stop using product and contact your supplier. Otherwise, continued use in such condition may cause electric shock or fire hazard.

8

⚠ CAUTION

Mount securely. Fall of A product may cause injury.

2. DETECTION AREA

WIDE ANGLE

LONG RANGE

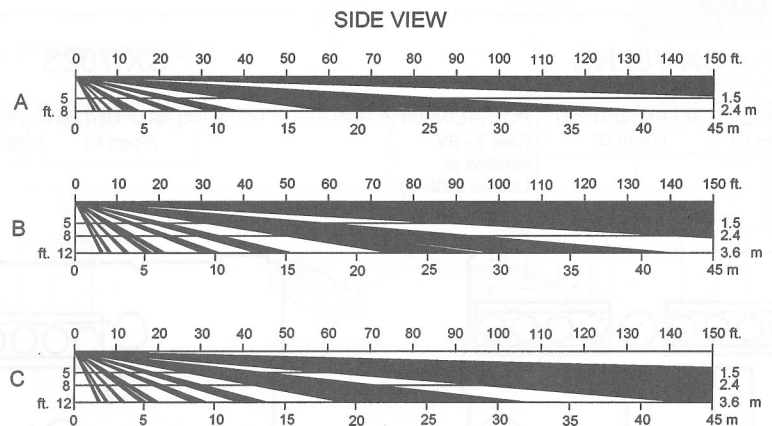
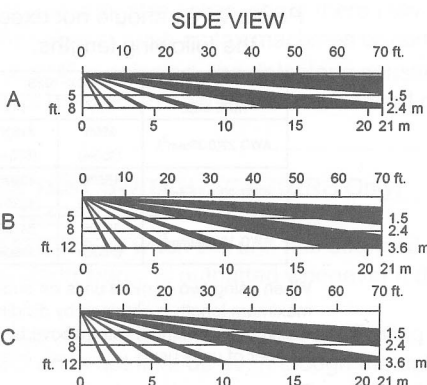
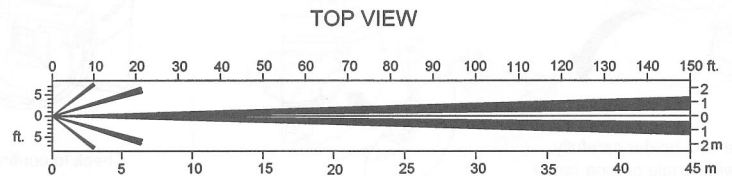
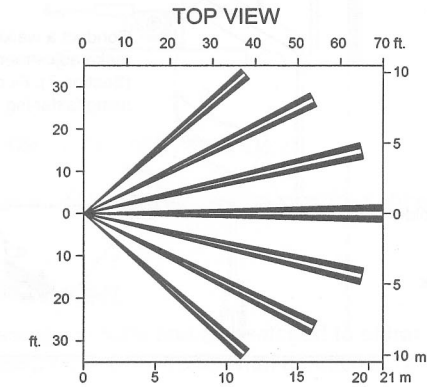

****ATTENTION****

The specified detection area can be achieved by mounting the unit at a height of 2.4m. Mounting at a lower or higher height may reduce the area of coverage.

3. DESCRIPTION AND OPERATION

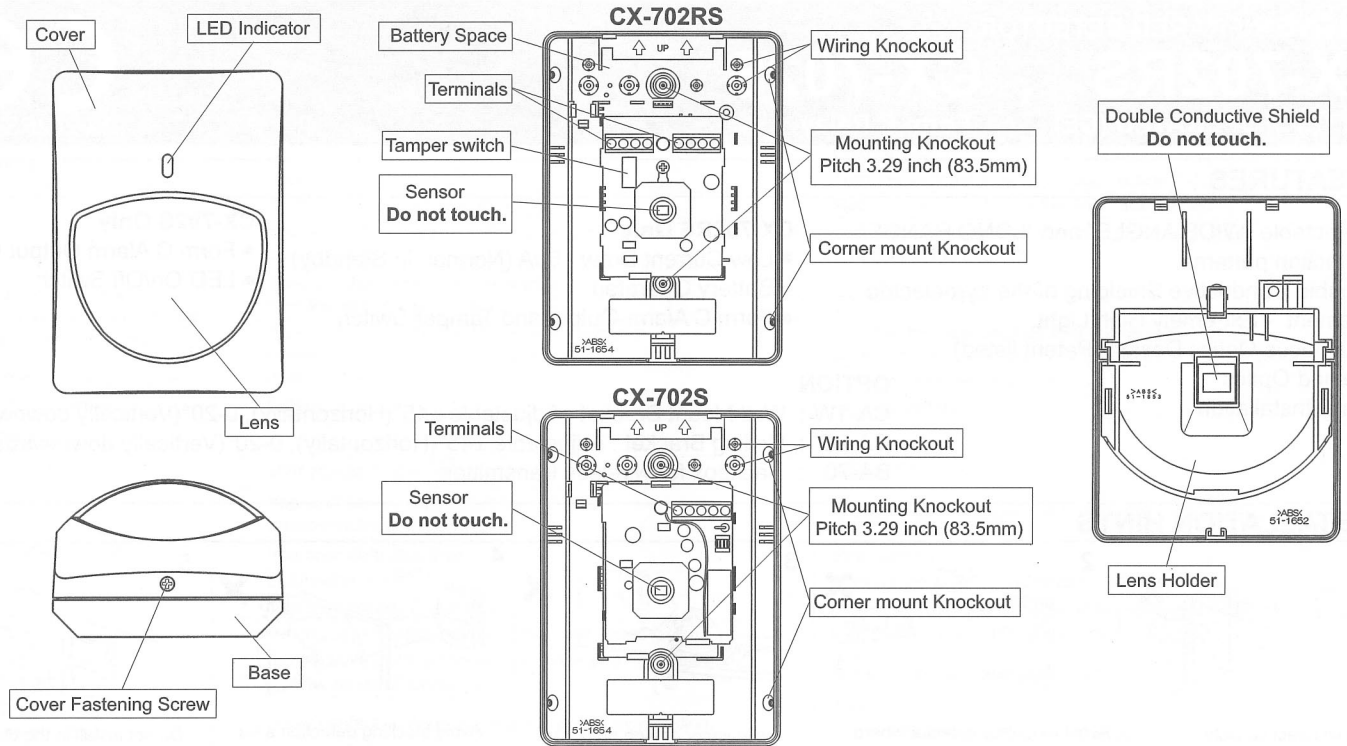

4. INSTALLATION

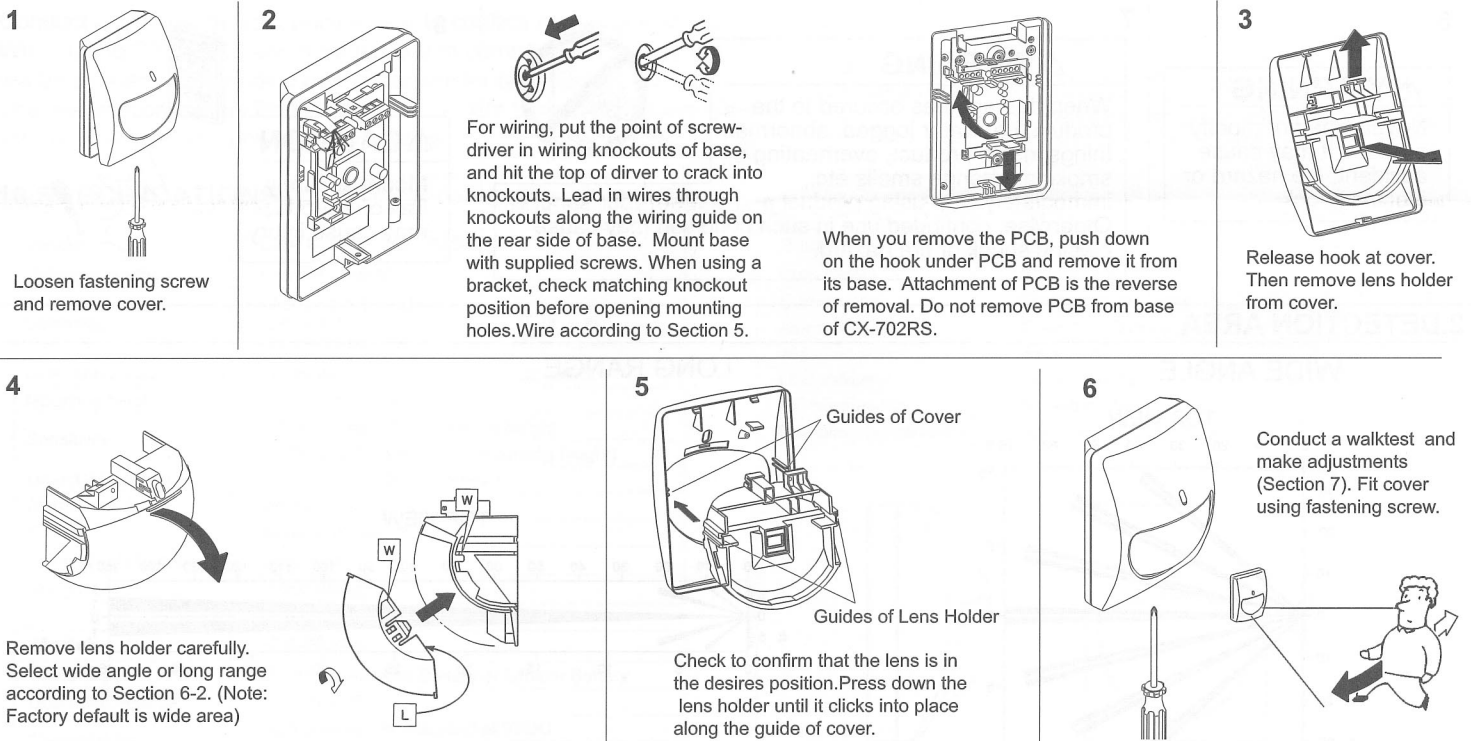

5. WIRING

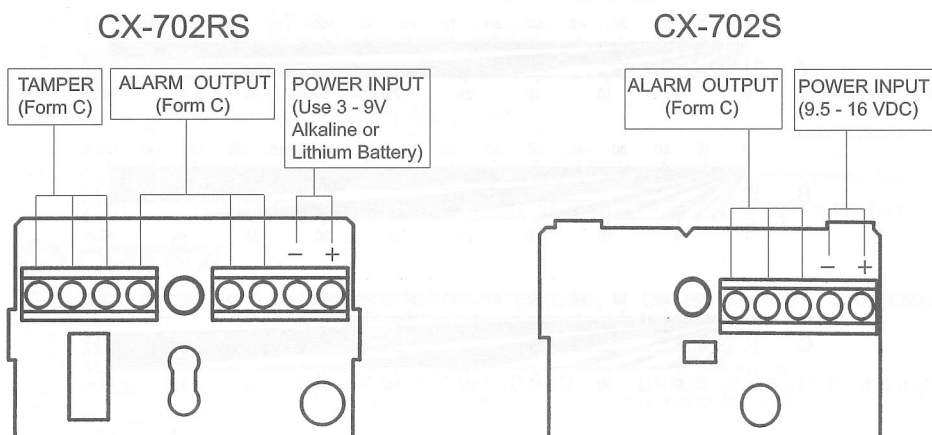

Power wires should not exceed the following lengths.

WIRE SIZE	CX-702S	
	12V	14V
AWG 22(0.33mm ²)	990ft (300m)	2150ft (650m)
AWG 20(0.52mm ²)	1560ft (470m)	3390ft (1030m)
AWG 18(0.83mm ²)	2500ft (760m)	5410ft (1650m)

When using two or more units on one wire, the maximum length is obtained by dividing the maximum wire length listed above by the number of units used.

[Connect tamper terminals to a 24 hour supervisory loop.]

6. ADJUSTMENTS FOR REQUIRED AREA PATTERN

The CX-702 is designed to provide ideal detection areas for different patterns ranging from 40ft.(12m) to 70ft.(21m) Wide Angle, and 80ft.(24m) to 150ft.(45m) Long Range.

The following adjustments will provide ideal detection areas for each of these requirements.

1. DETERMINE THE AREA PATTERN

Before making adjustments, determine the area pattern - detection range mounting height.

2. SELECTING WIDE ANGLE OR LONG RANGE DETECTION

1. Inverting the lens will select either the Wide Angle or Long Range detection patterns.
2. Please note markings "W(Wide Angle)" and "L(Long Range)", on each side of lens.
3. For Wide Angle, "W" will be on top of lens.
4. For Long Range, "L" will be on top of lens.

3. VERTICAL ADJUSTMENT OF DETECTION AREA

Adjust the vertical angle according to the desired detection range and mounting height.

1. Set the upper edge of the lens at either the "A", "B" or "C" position.
2. The following chart illustrates the different position setting.
3. Confirm the detection area by conducting a walktest.

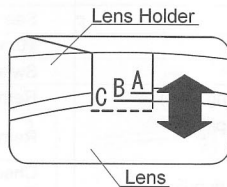

		W : WIDE ANGLE					L : LONG RANGE				
		DISTANCE					DISTANCE				
		40 (12)	50 (15)	60 (18)	70 (21)	80 (24)	100 (30)	120 (36)	150 (45)		
HEIGHT	6 (1.8)	B	A	A	A	B	B	A	A		
	8 (2.4)	C	C	C	C	C	C	C	C		
	12 (3.6)	C	C	C	C	C	C	C	C		

7. FUNCTIONS

CX-702RS

CX-702S

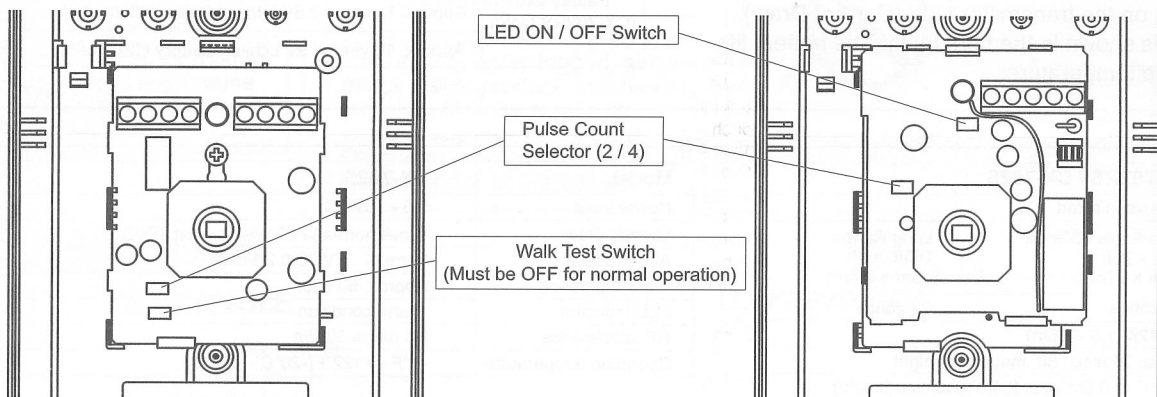

CAUTION!

Always conduct a walktest after changing the position of this switch to ensure the detector is still providing optimum coverage.

1. LED ON / OFF (CX-702S Only)

The Alarm LED indicator can be switched either "ON" or "OFF"



ON

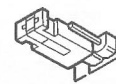

OFF

2. PULSE COUNT

The Detection Mode can be switched to either "2" or "4" mode depending on the environmental conditions of the installation.

- 2 : For normal applications.
- 4 : For use in hostile areas where there may be movement of small animals or other objects such as fax machines or curtains.

When the "4" is selected, the detector's sensitivity may seem sluggish. It is therefore important to always conduct a walktest to ensure that the desired coverage is given.



2

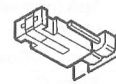

4

CAUTION!

Do not use pulse count 4 for Long Range detection.

3. WALK TEST SWITCH (CX-702RS Only)

WALK TEST

- 1) LED lights up when the unit has detected.
- 2) An alarm signal is outputted whenever it detects.

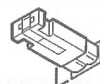

WALK TES

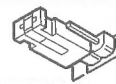

NORMAL

NORMAL : Normal Operation (Battery Saving Mode)

- 1) LED does not light up even though the unit detects.
- 2) The succeeding signals are not outputted even though it detects within 2 minutes after the first alarm is outputted. This is in order to save the battery consumption.

8.TROUBLE SHOOTING

CX-702RS

PROBLEM	PROBABLE CAUSE	REMEDY
Alarm is not activated although someone is walking in detection area.	Detection area is improper.	Conduct a walktest. See Section 2 and 7-3.
	Transmitter is not connected to PIR.	See Section 5.
	Wireless transmission has not arrived at a receiver.	Check the transmitter.
	Battery is dead.	Change battery.
	Walk Test switch is OFF.	Turn the walktest switch on. See Section 7-3.
	Polarity of the detector is Improper.	Replace the polarity of a terminal. See Section 5.
Alarm condition when no Alarm is activated although nobody is in the area.	Power supply voltage is Improper.(Disconnection or low voltage)	Check the wiring is correct or not. Or there is not a battery in the detector.
	Moving object within detection area. (curtain, wall hanging, etc.)	Remove the object from the detection area.
LED does not light up at the time of walktest.	Temperature of object within area is changing rapidly (heater, air conditioning, etc.)	Remove the heat sources from the detection area or relocate the detector.
	Walk Test switch is OFF.	Turn the walktest switch on.
	Battery is dead.	Change battery.

CX-702S

PROBLEM	PROBABLE CAUSE	REMEDY
LED does not light.	Improper power supply voltage. (disconnection, low voltage)	Correct supply voltage to 9.5 - 16V DC. See Section 5.
	Improper detection area.	See Section 2.
	LED switch is OFF.	Turn on the switch. See Section 7-1.
	Improper polarity to detector.	Switch positive and negative at terminal. See Section 5.
LED lights even though no person within area.	Moving object within area. (curtain, wall hanging, etc.)	Remove the sources from the detection area.
	Temperature of object within area changing rapidly (heater, air conditioning, etc.)	Remove object from the detection area.
LED lights but signal is not sent.	Relay contact is stuck or damaged due to overloading.	Check load of output. The unit needs repair or replacement.

9.MAINTENANCES

Conduct a walktest at least once a year to confirm proper operation. When using CX-702RS and a transmitter in common, the battery life will be shortened depending on the transmitter type (Current Draw). The assumption battery life is shown in the right table. The battery life will change depending on the temperature.

Battery Life (CX-702RS Only)	Approx. 3 years / 9V Alkaline Battery (560mAh)
	Approx. 7 years / 3.6V Lithium Battery (850mAh)
	Approx. 10 years / 9V Lithium Battery (1200mAh)

10.SPECIFICATIONS

Model	CX-702RS / CX-702S	
Detection method	Passive infrared	
Coverage	Wide Angle 85°wide 70ft. × 70ft. (21m × 21m)	Long Range 150ft. × 8ft. (45m × 2.4m)
	Detection zones	68 zones
Mounting height	5 - 12ft.(1.5 - 3.6m)	
Sensitivity	3°F at 2ft./sec., 8ft. mounting height	
	(1.6°C at 0.6m/sec., 2.4m mounting height)	
Detectable speed	1- 5ft. / sec. (0.3 - 1.5m/sec.)	
Alarm period	Approx. 2.5 sec.	
Pulse count	Approx. 20 sec. 2 or 4	
Environment humidity	95% max.	
Weight	7.0oz (200g)	

Model	CX-702RS
Power input	3 - 9VDC Alkaline Battery or Lithium Battery
Operating Voltage	2.3 - 10VDC
Current draw	5µA (normal : In Standby) at 9VDC
	10mA (max. : In Walktest, LED on) at 9VDC
Alarm output	Form C-Solid State Switch 10VDC 0.01A max.
Tamper switch	Form C.
Warm-up period	Approx. 90 sec.
LED indicator	Disabled during normal operation
	Alarm indicator optional (Walktest)
RF interference	No alarm 20V/m
Operating temperature	+14°F - +122°F(-10°C - +50°C)

Model	CX-702S
Power input	9.5 - 16VDC
Current draw	15mA(normal) / 20mA(max.) at 12VDC
Alarm output	Form C. 15VDC 0.2A max.
Warm-up period	Approx. 60 sec.
LED indicator	Alarm condition
RF interference	No alarm 30V/m
Operating temperature	-4°F - +122°F(-20°C - +50°C)

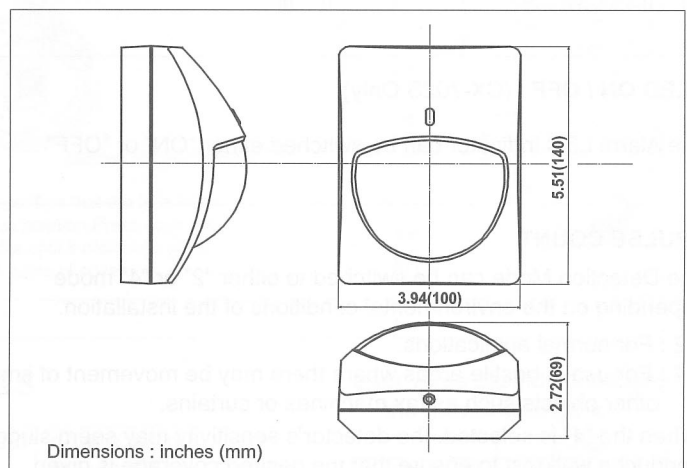

*Specifications and design are subject to change without prior notice.

This unit is designed to detect movement of an intruder and activate an alarm control panel. Being only a part of a complete system, we cannot accept responsibility for any damages or other consequences resulting from an intrusion. This product conforms to the EMC Directive 89/336 EEC.

5909743 07.08.30



OPTEX CO., LTD. (JAPAN)
(ISO9001 Certified by LRQA)
(ISO14001 Certified by JET)
5-8-12 Ogoto
Otsu, Shiga 520-0101
Japan
Tel: +81-77-579-8670
Fax: +81-77-579-8190
URL: http://www.optex.co.jp/e

OPTEX INCORPORATED(USA)
URL: http://www.optexamerica.com
Tel: +1-909-993-5770
Tech: (800)566-7839

OPTEX (EUROPE) LTD.(UK)
URL: http://www.optexeurope.com
Tel: +44-1628-631000

OPTEX SECURITY SAS (FRANCE)
URL: http://www.optex-security.com
Tel: +33-437-55-50-50

OPTEX SECURITY Sp.z o.o.(POLAND)
Tel: +48-22-598-06-55

OPTEX KOREA CO., LTD.(KOREA)
URL: http://www.optexkorea.com
Tel: +82-2-719-5971

OPTEX(DONGGUAN) CO., LTD. SHENZHEN OFFICE(CHINA)
URL: http://www.optexchina.com
Tel: +86-755-33302950