



PRODUCT

ALES QUAD

Product code ALES QUAD 160
ALES QUAD 250

ALES QUAD



QUADRUPLE OPTIC PERIMETER BARRIER

INSTALLATION AND MOUNTING MANUAL VERSION 1.2

Table of contents

1. Introduction.....	3
2. Product description.....	3
3. General warnings.....	4
3.1 Additional warnings for devices powered by mains voltage	
3.2 Installation warnings	
4. List of main components	5
5. Preparation for installation	6
5.1 Preparation of the barrier parts before installation	
5.2 It is advisable to carry out	
6. Examples of mounting/fixing	7
6.1 Placement and installation height	
6.2 Placement and mounting	
7. Evaluations before installation.....	9
7.1 Introduction to barriers	
8. Barrier positioning.....	10
8.1 Precautions before installation	
9. Wiring.....	11
9.1 Type of cable	
9.2 Connection of cables from power supply to barrier	
9.3 Connection for wired synchronism	
10. Barrier alignment	14
10.1 Calibration using SMA system	
10.2 Alignment	
11. Basic functions	17
11.2 Basic settings and programming - AQ BASE RX board	
11.2 Basic settings and programming - AQ BASE TX board	
11.3 Heater connections - AHTR	
12. Intervention time adjustment	20
13. Technical specifications.....	21
14. FAQ	22
15. Product disposal	23

1. Introduction

Congratulations on having purchased the Politec perimeter barrier. This appliance guarantees long-lasting and reliable operation if installed correctly. For correct and effective use, it is necessary to read this instruction manual carefully.



The system has been designed to detect intrusions and activate the alarm; it is not a device that prevents intrusion. Politec is not responsible for damage, injury or loss caused by accidents, theft, force majeure (including momentary lightning-induced overcurrent), abuse, improper or incorrect use, faulty installation or inadequate maintenance.

2. Product description

The double optic infrared perimeter barrier consists of an infrared receiver and transmitter. Operation is based on the "AND" logical operations: in other words, the alarm is activated only in the event of simultaneous interruption of two superimposed beams.

This barrier is ideal for perimeter protection of internal and external areas.
The main features of this barrier are:

- Adjustable intervention time which allows you to adapt to the characteristics of the site to be protected;
- Protection beam angle adjustment both vertically and horizontally;
- Set up for mounting on a wall, on a pole and on aluminium columns;
- Optical alignment with SMA function;
- Adjustable configuration for managing each individual optic
- Contact signalling barrier opening.



Warnings

Mounting, installation of the barrier and connection to the mains must be carried out by expert and qualified personnel, in compliance with rules and regulations applicable to electrical systems.

3. General warnings

This installation manual contains important information regarding safety for installation: it is necessary to read all the instructions before proceeding with the installation.

Keep this manual for future use.

- If you have any questions or doubts during installation, do not carry out any operations and contact the distributor's support service.
- Use of these products for purposes other than those specified in these instructions is prohibited.
- You must not make any change to the components of the product unless stated in the manual in order not to void the warranty; such operations can only lead to malfunctions; Politec assumes no liability for malfunctions or damage due to modified products.
- Depending on the specific situation of use, check for the need for additional devices: detectors or signalling devices.
- During installation, mounting and use of the product, make sure no foreign objects (solids, metals or liquids) are able to penetrate inside the open devices.
- Manufacturer's liability: Politec assumes no liability for failures resulting from incorrect installation; lack of maintenance, incorrect assembly or use.
- Politec is also not liable for incorrect or incomplete operation of the product or failure to detect intrusion.
- Warranty (summary of conditions): Politec guarantees its products for a period of 2 years from the production date. The warranty is applied to those purchasing directly from Politec; there is no warranty for the end user who, in the event of breakdowns or faults, must contact the installer or dealer.
- The warranty excludes aesthetic parts as well as parts subject to normal wear and parts subject to normal consumption such as batteries and accumulators.

3.1 Additional warnings for devices powered by mains voltage

This manual is intended only for technical personnel qualified to install such devices.

- Assessing the hazards that may occur during installation and use of the system, in order to achieve complete safety, it is necessary that installation takes place in full compliance with applicable laws, methods, rules and regulations.
- Before accessing the internal terminals of the product, it is necessary to disconnect all the power circuits.
- If automatic circuit breakers or fuses trip, before resetting them it is necessary to identify the fault and repair it.

3.2 Installation warnings

- Check that all the material to be used is in excellent condition and suitable for use.
- Before proceeding with the installation, check the environmental class of the products in the "technical specifications" chapter.
- Check, by comparing with the values shown in the paragraph "technical specifications", that the range of the devices is equal to or lower than the physical distance between the barriers.
- Check that the barrier is positioned in areas protected against potential impact, in flat areas and on fixed supports to avoid oscillations.
- Do not place the system components close to heat sources as they could be damaged.
- Each barrier has its own operating principle: check the instructions for choosing the right position in the respective instruction manual.



4. List of main components

The package contains the following components and accessories.

When opening the package, check that everything has been included.

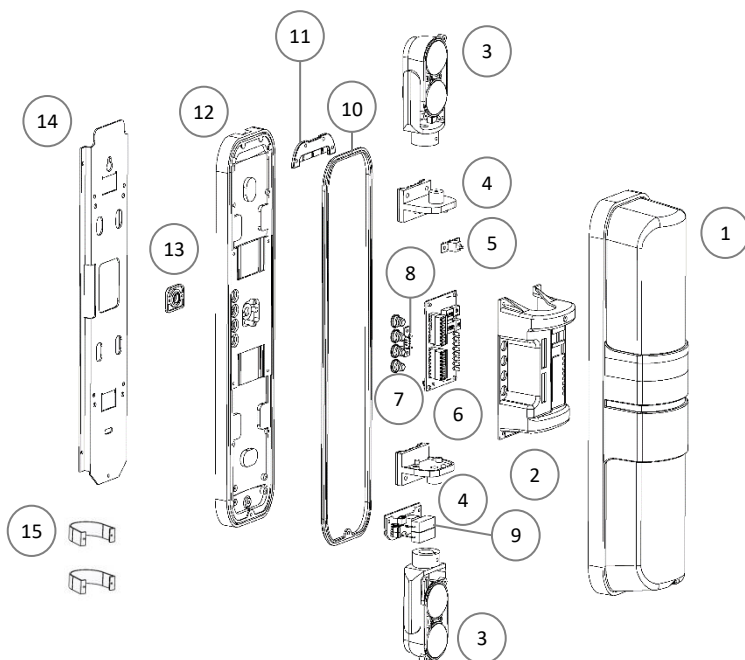

COMPONENT LIST

1	Polycarbonate black cover	9	AHTR thermostat control kit (present on AQ250)
2	Board cover	10	Gasket
3	Optics unit	11	Fixing plate stopper
4	Dis.TRG dual optics	12	Base Ales Quad
5 / 8	ATMP	13	Concentric stopper
6	Board	14	Wall fixing plate
7	Concentric gasket	15	U-shaped brackets for pole fixing

5. Preparation for installation

5.1 Preparation of the barrier parts before installation

Since the communication between the barriers can take place wired, via wireless and their alignment can be done optically, it is advisable to firstly check all the component parts of the barriers and any accessories before beginning the installation.

5.2 It is advisable to carry out:

- device configuration on a table;
- a check on the operation of the optical and acoustic alignment
- the permanent fixing of each device;
- the preparation and carrying out of electrical connections.

In order to avoid errors, operating and installation problems, it is advisable to proceed as follows:

- a) Place all the products with the package open on a table;
- b) For the low consumption barrier version for wireless models with universal electronic board housing, insert and connect the radio transmitter, and connect it to the barrier receiver board
- c) Power up the barriers and program them
- d) Test barrier operation;
- e) Place (without fixing) the barriers at the planned points;
- f) Place (without fixing) all the other devices at the planned points;
- g) Check for each barrier that there is sufficient field for radio communication (for wireless versions);
- h) Permanently fix the barriers.

Before proceeding with the installation, it is necessary to check the integrity of the product, the adequacy of the model chosen and the suitability of the environment intended for installation:

- Check that all conditions of use fall within the "limits of use" and in the "Technical specifications of the product".
- Check that the environment chosen for the installation is compatible with the total footprint of the product.
- Check that the surface chosen for the installation of the product is sturdy so as to ensure stable fixing and that it is adequately protected against possible impacts or the elements.



6. Examples of mounting/fixing

6.1 Placement and installation height

Position the barrier considering the type of surrounding environment and the protection distance for correct and effective operation.

Position it in such a way that there are no obstacles in its range of action (trees/plants or objects that can swing or move with the wind or rain).

Position the barrier so that sunlight does not hit it directly near the RX sensors.

However, it is necessary to take into consideration the specific beam diffusion of each model, to avoid reflection of the rays caused by the ground or by adjacent objects.

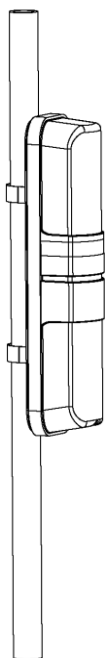

Pole mounting with wall brackets plus U-shaped brackets

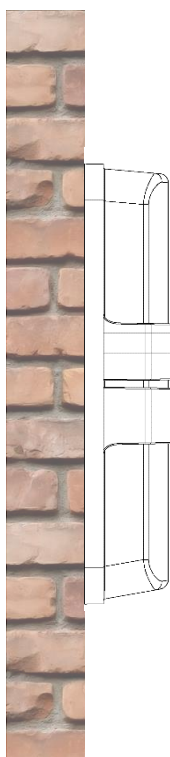

Wall mounting with wall brackets

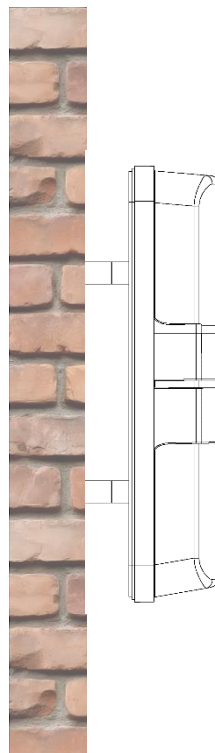

Wall mounting with wall brackets and appropriate spacers (recommended for long wall protection sections)

6.2 Placement and mounting

For wall mounting, the use of spacers is recommended when protecting openings (windows, doors etc.) along the wall, in order to avoid small obstacles (hinges, edges of windowsills etc.) that could be in the beams creating a signal attenuation.

Pole mounting with U-shaped brackets

The supplied brackets allow mounting on poles with a diameter of 48 - 50 mm.

- Drill an 8mm diameter hole on the pole for the passage of the connection cable
- Pass the connection cable through the hole
- Place the U-shaped brackets on the pole and fix them to the plate with the screws provided
- Make the connections on the terminal board
- After checking the alignment and correct operation, refit the cover and tighten the closing screw firmly.

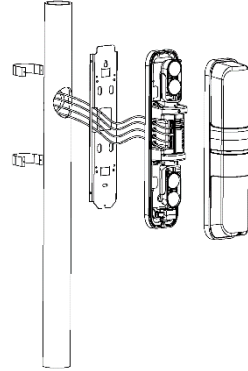

Wall mounting with spacers

Pass the connection cable through the hole in the fixing plate and fix the plate to the wall with the screws

- Make the connections on the terminal board
- After checking the alignment and correct operation, refit the cover and tighten the closing screw firmly.

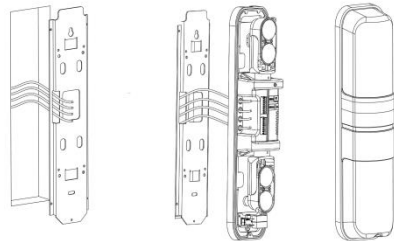

Wall mounting with fixing plate

- Measure the length of the barrier on the wall drilling at the holes on the bracket
- Loosen the plate locking screw and remove it by sliding the plate down against the aluminium profile of the barrier

WARNING:

Product warranty is invalid if there is any hole in the aluminium profile or any component

7. Evaluations before installation

7.1 Introduction to barriers

The Active Infrared Barrier is characterised by two components, a TX transmitter that emits a pulsed infrared signal towards the RX receiver. This signal is constantly controlled by a **CODED SYNCHRONISM** which can be **WIRED or OPTICAL** according to the different types of barriers.

The transmitted infrared beam takes on a conical shape: the greater the distance between TX and RX, the greater the diameter of the cone when it arrives.

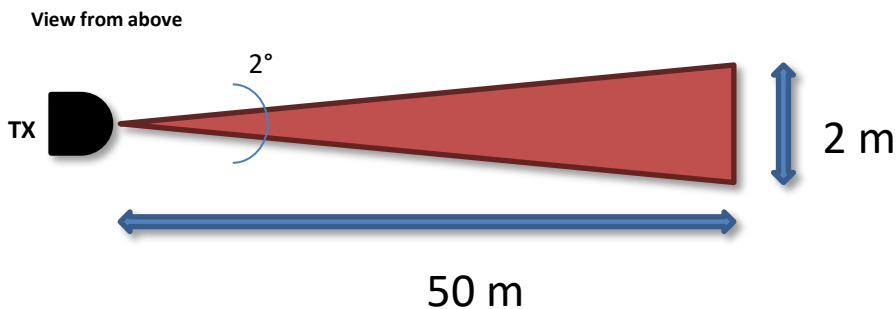

Signal interruption:ALARM

A barrier can be composed of several TX transmitters and RX receivers mounted inside specific different columns.

The infrared barriers have multiple controls that significantly limit false alarms, as the genuine alarm signal is given by the complete interruption of the infrared signal.

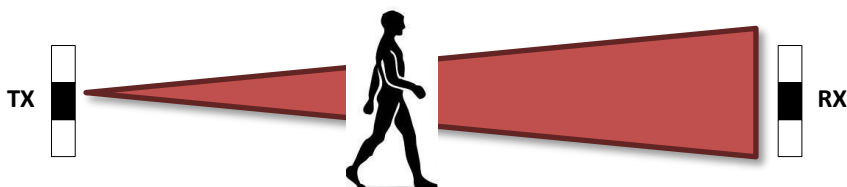

POWER SUPPLY

The barriers can be divided into two categories, powered at low voltage and connected by wire, or powered by batteries for Wireless systems, then combined with radio transmitters to communicate with the alarm control unit, as required by specific sector regulations.

HEATERS

It is recommended to power the thermostating system as, in conditions of high humidity, the condensation that is created on the screen can lead to a significant decrease in the IR signal up to the alarm. For obvious reasons, for battery powered barriers, there is no thermostat control even if set up, therefore to minimise the problem, it is necessary to reduce the working distance between TX and RX, thereby ensuring a good amount of signal constantly, even in case of particular climatic conditions.

8. Barrier positioning

8.1 Precautions before installation

In order to avoid false alarms, it is advisable to place the barriers away from reflecting surfaces, away from walls or anything that can attenuate the signal.

DO NOT place the barriers if there are plants, bushes or fixed objects in the range that obstruct the signal and create "grey areas". Leave a corridor of 50cm for distances between columns greater than 50m

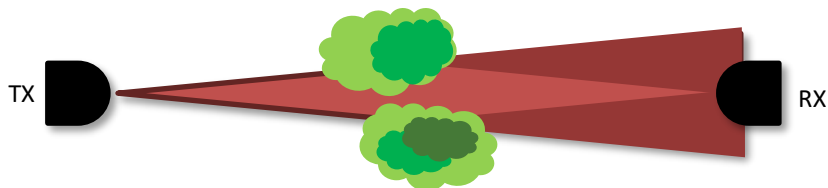

DO NOT place the barriers close to walls, without spacing the columns with adequate brackets: the signal quality may decrease

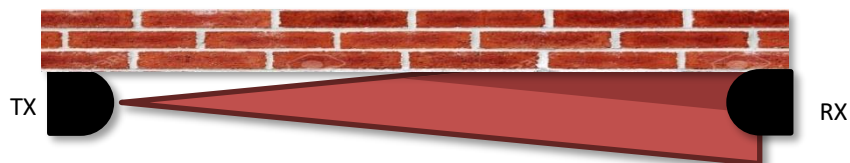

DO NOT place barriers close to roads: vehicle lights directed towards the RX could create disturbances

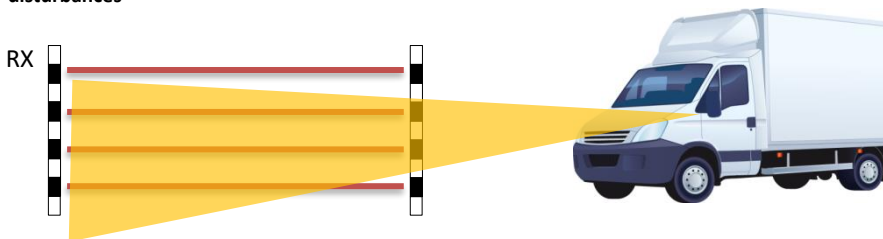

DO NOT place barriers near automatic gates: photocell signals can create interference.

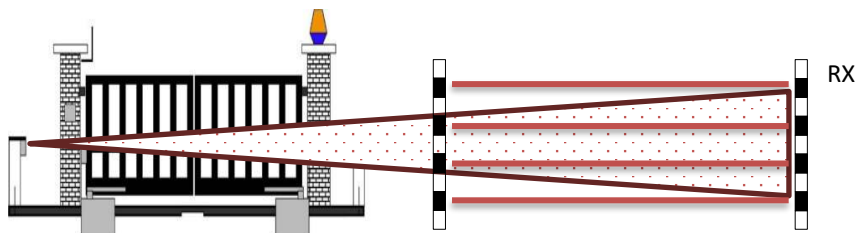

9. Wiring

9.1 Type of cable

Wiring requires you to **SEPARATE** the SHIELDED cable of the 12Vdc power supply plus all the signals to the control unit (e.g.2x0.5 + Nx0.22), from the power cable of the 24Vac heaters (optional for AQ 160m version) (e.g.2x0.75) to prevent the input of alternating voltage disturbances on the barrier.

N.B. it is absolutely necessary to shield the cable that supplies the 12 Vdc power supply and to ground the metal braid.



The sizing of the cables depends on the consumption of the columns and on the resistance of the cable itself according to the distances involved.

The table shows the cable cross-sections and the relative distances to ensure optimum performance using the LAR22 power supply (12Vdc-2.5A/24Vac-300W) and an ALES QUAD barrier (1 pair)

CONDUCTOR CROSS-SECTION	POWER SUPPLY BOARDS 12Vdc	POWER SUPPLY HEATERS 24Vac
0.5 mm ²	450 m	60 m
0.75 mm ²	700 m	90 m
1.5 mm ²	1400 m	180 m

The LAR22 can power up to 8 ALES QUAD barriers. The LAR22 container is metallic, so it must be placed inside a room or put in a watertight container if used outdoors. A battery up to 18Ah can be housed in the container.



9.2 Connecting cables from power supply to barrier

It is recommended to make a star-shaped connection to avoid excessive voltage drops on the power cables

The various examples shown here highlight the connection from the power supply to single columns, however it can also be carried out in cascade when two columns have been fixed on the same pole, having duly calculated: the distance, cable cross-section and consumption.

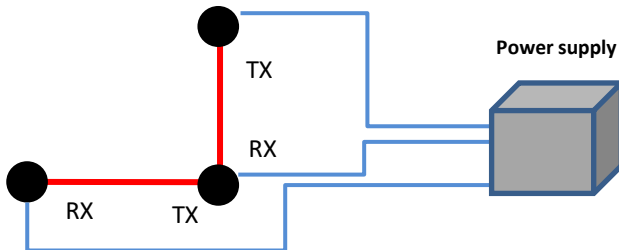
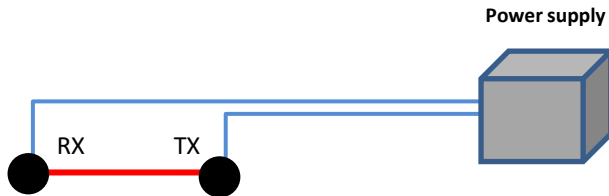
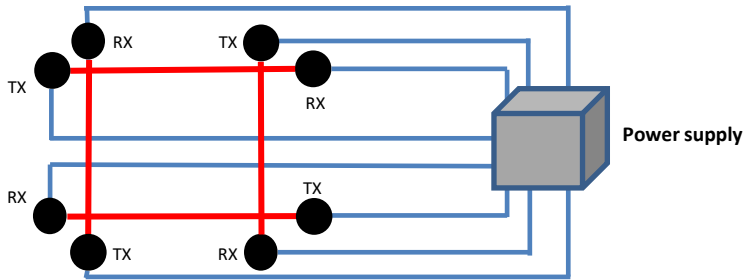

9.3 Connection for wired synchronism

The synchronism connections can be made directly in the control unit. Using a 2x0.22 shielded cable, connections up to 500 metres can be made. In the event of joints, the braid and shield connections must also be restored.

N.B.: Connect the power supply negatives of the common columns. It is possible to carry out this procedure by connecting the braids of the synchronism cables on both columns.

N.B.:In case of optical synchronism, the receiver must not get IR signals from other sources (photocells, other IR barriers etc.)

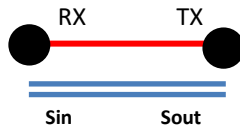

10. Barrier alignment

For correct alignment, once the barriers are installed, orient the optical units of the transmitters and the optical units of the receivers towards each other, adjusting the lens holder horizontally manually, after having loosened the locking screw on the joint and vertically through the front screw located to the left of the lens.

Vertical orientation

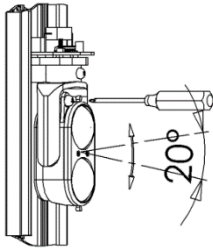

Horizontal orientation

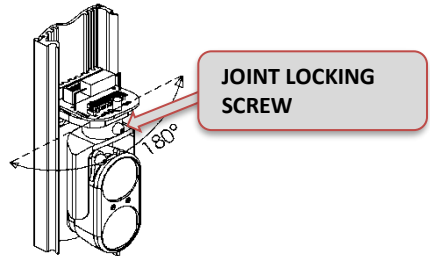

N.B.: Tighten the joint locking screw after the adjustment

10.1 Calibration using SMA system

It is possible to improve the calibration by using the supplied filter.

1. Fold the device following the pre-set folds.

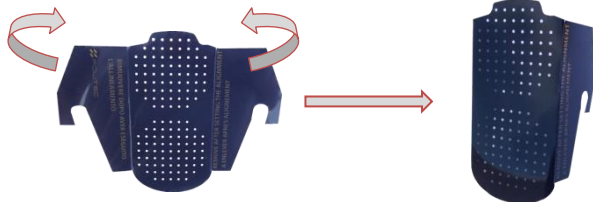

2. Position the filter in front of the TX optic positioning the two hooks on the pins of the optic fork. The filter is designed to refine the search for the alignment signal under adverse conditions.



It is sufficient to apply the filter only on the TX, there is no need to repeat the operation also on the RX.

10.2 Alignment

- Power the unit electrically
- Set the parameters relating to the various functions
- Set to ON TEST 1 DIP on the RX motherboard to enter the test with lower optic RX1.

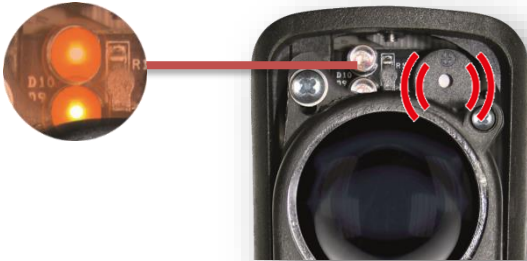

- Set to ON TEST 1 DIP on the TX motherboard to enter the test with lower optic TX1
- Orient the TX optic on the column towards the RX optic, vertically and horizontally acting as explained above, until you find the maximum alignment.

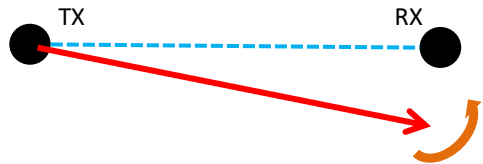

- The maximum alignment condition will be reached when the high-intensity LEDs are on steady and the buzzer will emit a continuous sound, for this reason, it may be necessary to make minor adjustments also on the RX optic.

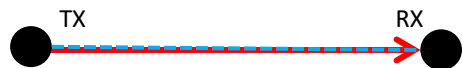

- N.B.: the fixed buzzer sound has a maximum duration of 3 minutes. To obtain a good alignment it is necessary to complete a FULL rotation on the horizontal axis of the RECEIVER optic, thereby performing the SCANNING of the optical signal.
- The partial or total misalignment condition is signalled by the infrequent flashing of the LEDs and by the non-continuous whistle of the buzzer.
- Exit the test of the optic by setting to OFF the DIP of TEST 1 on the TX motherboard
- Set to ON the TEST 2 DIP on the TX motherboard and repeat the alignment procedure for the crossed calibration of the barrier
- Once the operation is completed, set to OFF the TEST 1 DIP of the RX motherboard and the TEST 2 DIP of the TX motherboard
- Set to ON TEST 2 DIP of the RX motherboard to enter the test with the upper optic RX2
- Set the TEST 2 DIP of the TX motherboard to enter the test with the upper optic TX2
- Exit the test of the optic by setting to OFF the TEST 1 DIP on the TX motherboard
- Set to ON TEST 1 DIP of the TX motherboard and repeat the alignment procedure for the crossed calibration of the barrier
- After calibration, set to OFF the TEST DIPs on both motherboards, activating the automatic WALK TEST phase for 60 seconds

Once the calibration is completed, tighten the horizontal adjustment screw of all the optics.

At the end of the operation, remove the screen which acts as an attenuator, making sure to have found the optimal value.

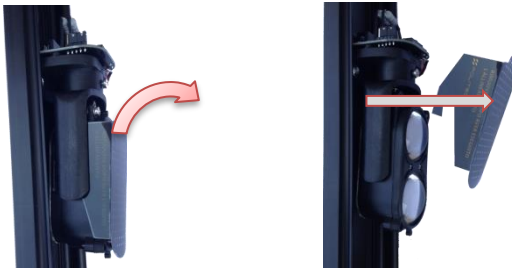

N.B.:Optical synchronism requires greater attention during the installation phases, in particular, that the receiving column is not affected by other sources of IR light.

To be absolutely certain that the alignment of the optics is correct (and therefore no false alignments due to the transmission of other infrared sources, such as other barriers of the same system as well as gate photocells) cover the TRANSMITTER optic with your hand: if the RECEIVER continues to give a continuous beep, it means that it sees another infrared source that must be turned off and eliminated.



11. Basic functions

11.2 Basic settings and programming - AQ BASE RX board

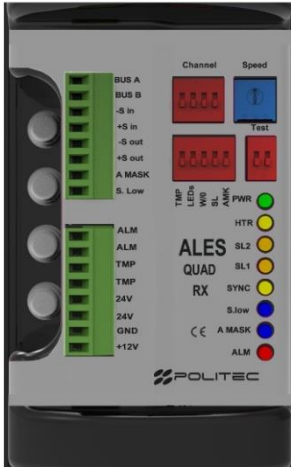

LED INDICATORS

- POWER: On if powered
- HTR: Heaters on if present
- SL2: Low signal upper RX optic
- SL1: Low signal lower RX optic
- SYNC: Very fast flashing (side with RX optic inside and wired synchronism)
- SLOW: Fog disqualification
- AMASK: Antimask
- ALM: On if barrier in alarm

INTERVENTION TIME ADJUSTMENT TRIMMER

RECEPTION DIP

- Channel 1-4: Used with optical synchronism

SMA TEST DIP

- DIP1: Lower optic test RX1
- DIP2: Upper optic test RX2

5 DIP UNIT FOR CONFIGURATION

- **DIP1:** Enables anti-tear tamper
- **DIP2:** Enables LED indicators
- **DIP3:** ON for OPTICAL synchronism, OFF for WIRED synchronism
- **DIP4:** Enables fog disqualification
- **DIP5:** Enables antimask

TERMINAL BOARD DESCRIPTION

Bus A / Bus B	Not in use
Sin - / Sin +	Input synchronism
Sout - / Sout +	Not in use
A Mask	O.C. active IR masking signal output:NO to GND
Slow	O.C. fog disqualification signal output:NO to GND
ALM / ALM	NC alarm output
TMP / TMP	NC tamper output
24V / 24V	Heater power supply
GND / 12V	12V power supply



11.2 Basic settings and programming - AQ BASE TX board

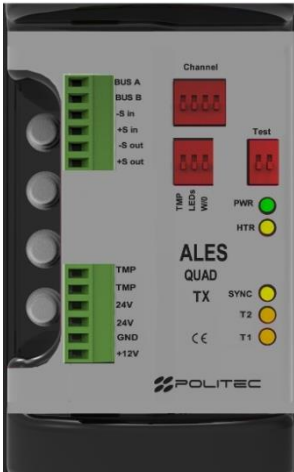

LED INDICATORS

- POWER: On if powered
- HTR: Heaters on if present
- SYNC: Very fast flashing (side with RX optic inside and wired synchronism)
- T2: TX2 upper optic in TEST
- T1: TX1 lower optic in TEST

TRANSMISSION DIP

- Channel 1-4: Used with optical synchronism

SMA TEST DIP

- DIP1: Lower optic test TX1
- DIP2: Upper optic test TX2

3 DIP UNIT FOR CONFIGURATION

- **DIP1:** Enables anti-tear tamper
- **DIP2:** Enables LED indicators
- **DIP3:** ON for OPTICAL synchronism, OFF for WIRED synchronism

TERMINAL BOARD DESCRIPTION

Bus A / Bus B	Not in use
Sin - / Sin +	Output synchronism
Sout - / Sout +	Not in use

TMP / TMP	NC tamper output
24V / 24V	Heater power supply
GND / 12V	12V power supply



11.3 Heater connections - AHTR

The ALES QUAD TS kit is already present and connected in the AQ 250 version, while it is optional in the AQ 160 version, in this case, connect the AHTR board with the cable provided and fix it at the bottom to each TX and RX column, using the screws supplied.

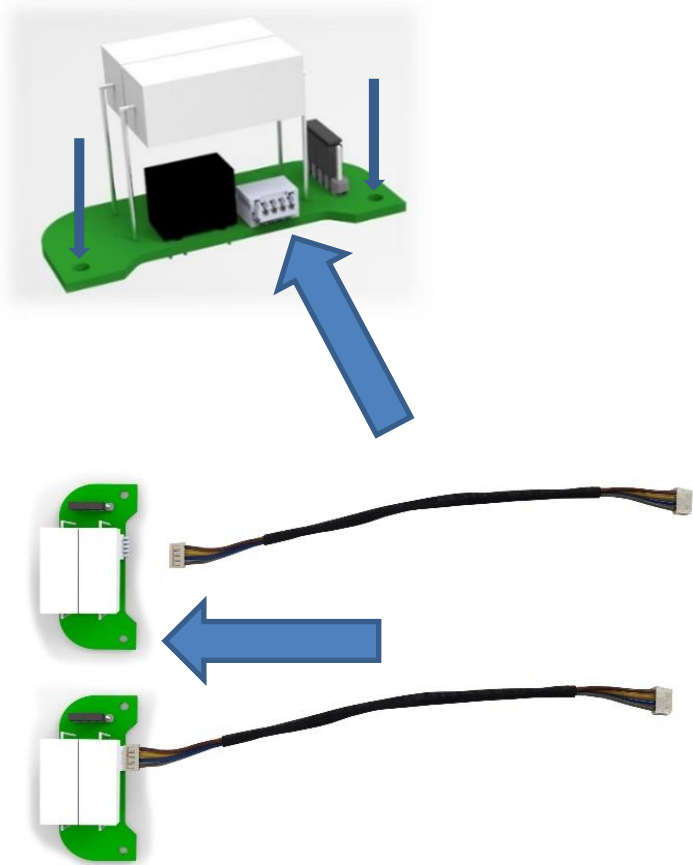

N.B.:The jumpers must be positioned on 24V or 12V depending on the type of power supplied for the heaters only

12. Intervention time adjustment

On the RX board there is a potentiometer to adjust the INTERVENTION TIME. In particular, it is possible to set the barrier for rapid (crossing while running) or slow (crossing while walking) alarms.

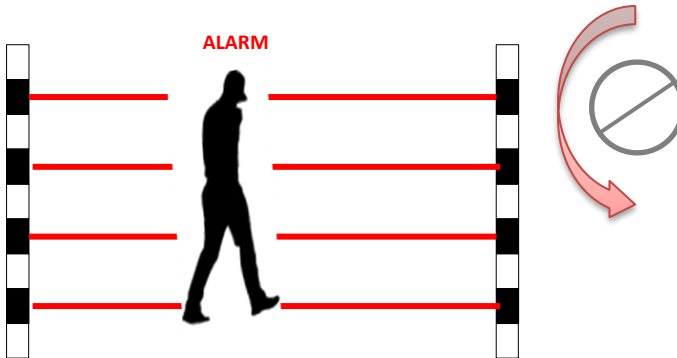

By adjusting the potentiometer anticlockwise, the intervention time is increased up to 500ms. In this condition, the alarm of a person crossing the barrier while walking is guaranteed, with the advantage of excluding the possibility of any false alarms (e.g. animal crossing).
By adjusting the potentiometer clockwise, the intervention time decreases down to 50ms. In this condition, the alarm of a person crossing the barrier running at maximum speed is guaranteed.
Working with 2 beams, the barrier must be installed at a height greater than 70cm from the ground to effectively detect a person running

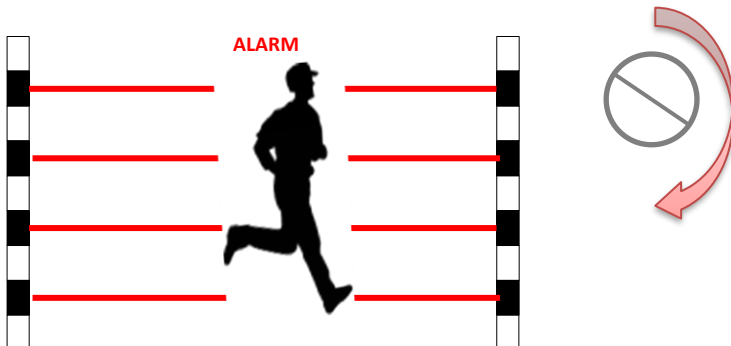

13. Technical specifications

OUTDOOR RANGE	250 m (AQ 250) - 160 m (AQ 160)
INDOOR RANGE	500 m (AQ 250) - 320 m (AQ 160)
SYNCHRONISATION	Wired / Optical 4 channels
OPTICAL SENSORS	Double optics with pulsed beams 950 nm
CALIBRATION	Crossed beams
DISQUALIFICATION	Automatic, if enabled, with external signalling, O.C.:NO to GND
MASKING	Masking detection with other Infrared signal with outward signalling, O.C.:NO to GND
OPERATING TEMPERATURE	- 25°C / + 70°C. Heater kit available for temperatures down to -50°C
ALIGNMENT ANGLES	20° Vertical - 180° horizontal
DETECTION SYSTEM	AND
EXTERNAL SCREEN	Infrared with UV filter.
OUTPUTS	NC alarm relay and NC alarm tamper Cover opening and anti-tear setting with DIP SW
INGRESS PROTECTION RATING	IP 65

STANDARD MODELS:ALES QUAD 160m – ALES QUAD 250m

Total beams	2TX + 2RX
Power supply	12-24Vdc
Consumption	50 mA
Heaters in column	25W 24V - 12V ac/dc with thermostat (optional on AQ 160)

14.FAQ

<p>I can't align</p>	<p>Check that there are no obstacles of any kind interposed between RX and TX and that the conditions of the site do not represent an impediment;</p>
	<p><u>N.B. remember to reactivate the optics once the alignment operation is finished.</u></p>
	<p>Check that the power supply on the terminal board is sufficient;</p>
	<p>Use the shielded cable for the power supply by connecting the braiding to the earth (in case of persistent problem, it is recommended to connect the alarm and power supply/tamper with two separate shielded cables);</p>
	<p>Check the correct sizing of the power cables;</p>
	<p>Make sure there are no external light sources that interfere with the correct reading of the signal (gate photocells, other barriers, infrared etc.);</p>
	<p>For barriers with multiple devices positioned on the same line, it is necessary to switch off the TXs on which the alignment operation is not being performed</p>
<p>The system goes into disqualification even in the absence of fog</p>	<p>Make sure that the power supply of the heaters is greater than 20 Vac at the barrier terminal board.</p>
	<p>Check the alignment accuracy of each individual optic and, if necessary, carry out the procedure by performing a complete scan, making sure that there are no light sources that can influence the calibration;</p>
	<p>For more precise alignment, position one side of the column cover in front of the lenses in order to have two surfaces interposed between TX and RX to double the attenuation of the beam.</p>
<p>After accurately aligning the sensor (LED light on steady and continuous BEEP) the system remains in alarm</p>	<p>Make sure that all the negatives of the barriers are in common with each other and with the negative of the control unit in case of operation with wired synchronism;</p>
	<p>Make sure that the connectors are well inserted and that the DIP configuration is correct;</p>
	<p>Make sure there are no external light sources that interfere with the correct reading of the signal (gate photocells, other barriers, infrared etc.)</p>
	<p>Use the shielded cable for separate power supply and synchronism by connecting the braid to the earth;</p>
	<p>Check the sizing of the power cables;</p>



The system goes into alarm with fog and rain	Check that the fog disqualification function is active.
	Make sure that the power supply of the heaters is greater than 20 Vac at the barrier terminal board.
	Make sure that the structure is well sealed and check that there are not already elements inside which could create disturbance (water, insects etc.);
	Check the alignment accuracy of each individual optic and, if necessary, carry out the procedure by performing a complete scan, making sure that there are no light sources that can influence the calibration;
	For more precise alignment, position one side of the column cover in front of the lenses in order to have two surfaces interposed between TX and RX to double the attenuation of the beam.
Repeated false alarms	Check the alignment accuracy of each individual optic and, if necessary, carry out the procedure by performing a complete scan, making sure that there are no light sources that can influence the calibration.
	If possible, increase the intervention time.
	Make sure that the power supply of the heaters is greater than 20 Vac at the barrier terminal board.
	Use the shielded cable for separate power supply and synchronism by connecting the braid to the earth;
	Check the correct sizing of the power cables.

15. Product disposal.

All components of this barrier are an integral part of the equipment and must be disposed of together with it. Just as with installation operations, also at the end of life of these products, the dismantling operations must be carried out by qualified personnel.

These products are made up of various types of materials: some can be recycled and others must be disposed of. Find out about available recycling or disposal systems for this category of products governed by regulations in force in your area.

Warning!- Some parts of the products may contain polluting or dangerous substances which, if dispersed in the environment, could result in harmful effects on the environment itself and on human health. As indicated by the symbol on the side, it is forbidden to throw these products in domestic waste. Therefore, carry out "separate collection" for disposal, according to the methods stipulated by the regulations in force in your area or return the products to the seller when purchasing a new equivalent product.

Warning!- Local regulations can impose heavy penalties for incorrect disposal of these products.





For technical support, contact your security systems distributor