

AC-225x-B Series

Expandable 2-Reader Networked Access Control Panel

Hardware Installation and User Manual

Models:

AC-225-Bx

AC-225-DIN

AC-225IP-Bx

AC-225IP-DIN



Copyright © 2022 by Rosslare. All rights reserved.

This manual and the information contained herein are proprietary to ROSSLARE ENTERPRISES LIMITED and/or its related companies and/or subsidiaries' (hereafter: "ROSSLARE"). Only ROSSLARE and its customers have the right to use the information.

No part of this manual may be re-produced or transmitted in any form or by any means, electronic or mechanical, for any purpose, without the express written permission of ROSSLARE.

ROSSLARE owns patents and patent applications, trademarks, copyrights, or other intellectual property rights covering the subject matter in this manual.

TEXTS, IMAGES, AND ILLUSTRATIONS INCLUDING THEIR ARRANGEMENT IN THIS DOCUMENT ARE SUBJECT TO THE PROTECTION OF COPYRIGHT LAWS AND OTHER LEGAL RIGHTS WORLDWIDE. THEIR USE, REPRODUCTION, AND TRANSMITTAL TO THIRD PARTIES WITHOUT EXPRESS WRITTEN PERMISSION MAY RESULT IN LEGAL PROCEEDINGS.

The furnishing of this manual to any party does not give that party or any third party any license to these patents, trademarks, copyrights or other intellectual property rights, except as expressly provided in any written agreement of ROSSLARE.

ROSSLARE reserves the right to revise and change this document at any time, without being obliged to announce such revisions or changes beforehand or after the fact.

Table of Contents

1. Introduction	8
2. Technical Specifications.....	10
2.1 AC-225x-DIN	10
2.2 AC-225x-B Installed in ME-1015	11
3. AC-225x-B Panel Setup.....	12
3.1 Inputs Wiring – Non-Supervised Inputs.....	13
3.2 Inputs Wiring – Supervised Inputs.....	13
3.3 Outputs Wiring	14
3.4 Power Supply.....	16
3.5 AC-225x-B Wiring Communications	17
3.6 Reader	18
3.7 MD-IO84B.....	18
3.8 MD-D02B	18
4. Input and Output Connections	19
4.1 Input Types.....	19
4.1.1 Normally Open Input Connection	19
4.1.2 Normally Closed Input Connection	20
4.1.3 Normally Open Supervised Single Resistor Input Connection.....	20
4.1.4 Normally Open Supervised Double Resistor Input Connection.....	20
4.1.5 Normally Closed Supervised Single Resistor Input Connection.....	21
4.1.6 Normally Closed Supervised Double Resistor Input Connection	22
4.2 Inputs Description	22
4.2.1 Request-to-Exit (REX) Button Input	22
4.2.2 Door Monitor Input	22
4.2.3 General Purpose Inputs	23
4.3 Outputs.....	23
4.4 Card Readers and Keypads	24

Table of Contents

5. AC-225x-B Hardware Settings	26
5.1 DIP Switch Configuration	26
5.2 Access Control Panel Baud Rate	27
5.3 Access Control Panel Type.....	27
5.4 Access Control Panel Addressing.....	29
6. Communications	31
6.1 Serial Network Connection.....	31
6.1.1 RS-232 Connection to the Computer	31
6.1.2 RS-485 Connection to the Computer	32
6.1.3 Daisy Chaining	33
6.2 TCP/IP Network Connection	34
6.2.1 LAN and WAN Requirements.....	34
A. Declaration of Conformity.....	36
B. Radio Equipment Directive (RED)	37
C. RoHS Directive	38
D. UL 294 7th Edition	39
E. Limited Warranty.....	40

List of Figures

Figure 1: AC-225x-B Panel Layout	9
Figure 2: AC-225x-B Sample Configuration	12
Figure 3: Inputs Wiring – Non-supervised Inputs	13
Figure 4: Door Lock – Failed Close	14
Figure 5: Door Lock – Failed Open	15
Figure 6: Wiring Between PM-10 and AC-225x-B	16
Figure 7: AC-225x-B Wiring Communications	17
Figure 8: Reader Wiring	18
Figure 9: Connector Location for MD-IO84B or MD-D02B Expansions	18
Figure 10: Normally Open Input Connection	19
Figure 11: Normally Closed Input Connection	20
Figure 12: Normally Open Supervised Input Connection (Single Resistor)	20
Figure 13: Normally Open Supervised Input Connection (Double Resistor)	21
Figure 14: Normally Closed Supervised Input Connection (Single Resistor)	21
Figure 15: Normally Closed Supervised Input Connection (Double Resistor)	22
Figure 16: DIP Switches	26
Figure 17: RS-232 Panel Connection to PC	31
Figure 18: RS-485 Panel Connection to PC	32
Figure 19: Daisy Chaining	33
Figure 20: Connecting Multiple Access Control Panels to AC-225IP	34
Figure 21: Connecting a Single Control Panel with MD-N32	34
Figure 22: Connecting Multiple Access Control Panels with MD-N32	35

List of Tables

Table 1: Description of AC-225x-B Panels	8
Table 2: DIP Switches and Their Functions.....	26
Table 3: Switch Baud Rates	27
Table 4: Possible Hardware Settings	27
Table 5: Available Panel Addresses.....	29
Table 6: RS-232 Connection	32
Table 7: UL 294 Access Control Performance Ratings.....	39

Notice and Disclaimer

This manual's sole purpose is to assist installers and/or users in the safe and efficient installation and usage of the system and/or product, and/or software described herein.

BEFORE ATTEMPTING TO INSTALL AND/OR USE THE SYSTEM, THE INSTALLER AND THE USER MUST READ THIS MANUAL AND BECOME FAMILIAR WITH ALL SAFETY REQUIREMENTS AND OPERATING PROCEDURES.

- The system must not be used for purposes other than those for which it was designed.
- The use of the software associated with the system and/or product, if applicable, is subject to the terms of the license provided as part of the purchase documents.
- ROSSLARE exclusive warranty and liability is limited to the warranty and liability statement provided in an appendix at the end of this document.
- This manual describes the maximum configuration of the system with the maximum number of functions, including future options. Therefore, not all functions described in this manual may be available in the specific system and/or product configuration you purchased.
- Incorrect operation or installation, or failure of the user to effectively maintain the system, relieves the manufacturer (and seller) from all or any responsibility for consequent noncompliance, damage, or injury.
- The text, images and graphics contained in the manual are for the purpose of illustration and reference only.
- All data contained herein subject to change without prior notice.
- In no event shall manufacturer be liable for any special, direct, indirect, incidental, consequential, exemplary, or punitive damages (including, without limitation, any and all damages from business interruption, loss of profits or revenue, cost of capital or loss of use of any property or capital or injury).
- All wiring diagrams are intended for reference only, the photograph or graphic of the PCB(s) are intended for clearer illustration and understanding of the product and may differ from the actual PCB(s).

1. Introduction



Note

In this manual, unless otherwise stated, “AC-225x-B” refers to both the regular AC-225-B and the AC-225IP-B models.

The AC-225x-B series of access control panels are state-of-the-art networked access controllers, employing the latest technology to meet the requirements of the market.

Table 1 summarizes the series of AC-225x-B models and their respective descriptions.

Table 1: Description of AC-225x-B Panels

Model Name	Description
AC-225-BA	Installed in ME-1015 with Type I plug power cable
AC-225-BB	Installed in ME-1015 with Type G plug power cable
AC-225-BE	Installed in ME-1015 with Type F plug power cable
AC-225-BU*	Installed in ME-1015 with Type B plug power cable
AC-225-DIN*	PCBA only with wall / DIN rail mounting base
AC-225IP-BA	Installed in ME-1015 with Type I plug power cable
AC-225IP-BB	Installed in ME-1015 with Type G plug power cable
AC-225IP-BE	Installed in ME-1015 with Type F plug power cable
AC-225IP-BU*	Installed in ME-1015 with Type B plug power cable
AC-225IP-DIN*	PCBA only with wall / DIN rail mounting base

* UL Certified



Note

The IP models also includes onboard support for communications across a TCP/IP network.

When used in combination with Rosslare's AxTraxNG™ or AxTraxPro™ Access Control Management Software, the AC-225x-B gives you full control over access to your premises. The system can control both single and double door entrances and up to four doors, with MD-D02B 2-door expansion module. AC-225x-B supports up to 30,000 users and uses flash memory to enable easy firmware upgrades. For more information on AxTraxNG/AxTraxPro Access Control Management Software, refer to the *AxTraxNG User Guide* or the *AxTraxPro User Guide*.

The AC-225x-B comes either as a PCBA “DIN” module that can be wall or DIN rail mountable, or pre-assembled within the ME-1015 power management enclosure. The ME-1015 contains a universal switch mode power supply that accepts inputs from 90 ~ 240 VAC (50 ~ 60 Hz) and outputs 60 watts, a power management board that provides two independently fused 12 VDC, 2 Amp power outputs – one for the controller and readers, and one for locks. The ME-1015 power management

Introduction

enclosure also includes an alert sounder, a lead acid battery charger for a lead acid battery of up to 12 V and 7 Ah, and an intelligent light bar that provides enclosure lighting, an enclosure tamper sensor, and a power status LED indicator.

Figure 1 shows the general layout of the AC-225x-B panel.

Figure 1: AC-225x-B Panel Layout

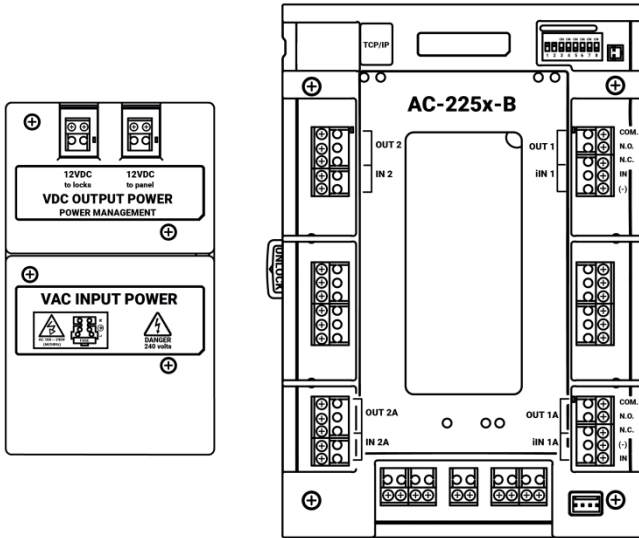

2. Technical Specifications

2.1 AC-225x-DIN

Electrical Characteristics

Operating Voltage	12 VDC, 1.5 A from a regulated power supply	
Maximum Input Current	AC-225	Standby: 80 mA Maximum: 325 mA
	AC-225IP	Standby: 120 mA Maximum: 370 mA
General Inputs	<ul style="list-style-type: none"> • 4 supervised high impedance inputs • 8 or 12 supervised inputs when using MD-D02B or MD-IO84B expansion boards • Maximum voltage: 5 VDC 	
Relay Outputs	<ul style="list-style-type: none"> • 4 Form C 5 Amp relay outputs • 8 outputs when using MD-D02B or MD-IO84B expansion boards 	
Reader Ports	<ul style="list-style-type: none"> • 2 reader ports, 4 reader ports when using MD-D02B • Communication: Wiegand (D0, D1) or Clock & Data (C, D) • Output voltage to reader: 12 VDC (battery only: 8.8-11.8 VDC) • Max. current to reader: 245 mA • LED control output and Tamper Input 	
Visual Indicators	11 LEDs for outputs and communication status	
Audio	Sounder output for use with compatible speakers provides chime, bell, and siren signals	
Battery Standby Time	3 hours with a 12 V, 7 Ah lead acid battery	

Communication Characteristics

RS-485 / RS-232	<ul style="list-style-type: none"> • RS-485 or optional RS-232 • RS-485 connection by terminal block or MD-14U connector • RS-232 connection by terminal block
RS-232	Terminal Block
RS-485	Molex and Terminal Block
TCP/IP	On-board RJ-45 connector (functional on AC-225IP models only)
Selectable Communication Speed	9600, 19200, 57600, 115200 bps

Technical Specifications

Environmental Characteristics

Operating Temperature Range	0°C to 49°C (32°F to 120°F)
Operating Humidity Range	0 to 85% (non-condensing)
Dimensions	
Height x Width x Depth	193 x 136.5 x 39 mm (7.6 x 5.4 x 1.5 in.)
Weight	0.36 kg (12.7 oz)

2.2 AC-225x-B Installed in ME-1015

Electrical Characteristics – Switch Mode Power Supply

Operating Voltage	90 ~ 240 VAC, 50 ~ 60 Hz from mains power
Maximum Input Current	1.5 A
Output Power	15 VDC, 4 A (60 Watts) to the power management board

Electrical Characteristics – Power Management Board (PM-10)

Input Power	15 VDC, 4 A to the power management board
Output Power	Two PTC fused outputs Each provides 13.8 VDC, 1.5 A (battery only: 8.8-11.8 VDC) One output for controller and readers One output for locks
Battery Charger	13.8 VDC, 300 mA for 12 VDC, 7 Ah Lead Acid Battery
Speaker	0.5-Watt, 8 Ohm
Light Bar	0.3 Watt for LED light

Environmental Characteristics

Operating Temperature Range	0°C to 49°C (32°F to 120°F)
Operating Humidity Range	0 to 85% (non-condensing)
Dimensions	
Height x Width x Depth	364 x 264 x 87.4 mm (14.3 x 10.4 x 3.4 in.)
Weight	3.4 kg (7.5 lb)

3. AC-225x-B Panel Setup

Each AC-225x-B panel controls one or two doors (up to 4 doors with MD-D02B). The panels connect together in a network and are controlled by a central server computer, running the AxTraxNG/AxTraxPro Access Control Management Software.

Figure 2 shows an example setup for a network of AC-225x-B access control panels.

Figure 2: AC-225x-B Sample Configuration

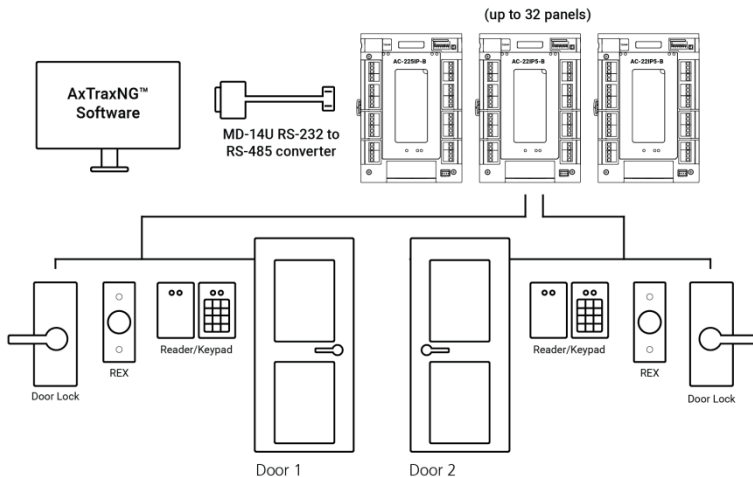

 **Note** The use of bushings is required for any conductors leaving the enclosure through the provided openings.

3.1 Inputs Wiring – Non-Supervised Inputs

Figure 3 presents a detailed view of the non-supervised inputs and their connection options.

Figure 3: Inputs Wiring – Non-supervised Inputs

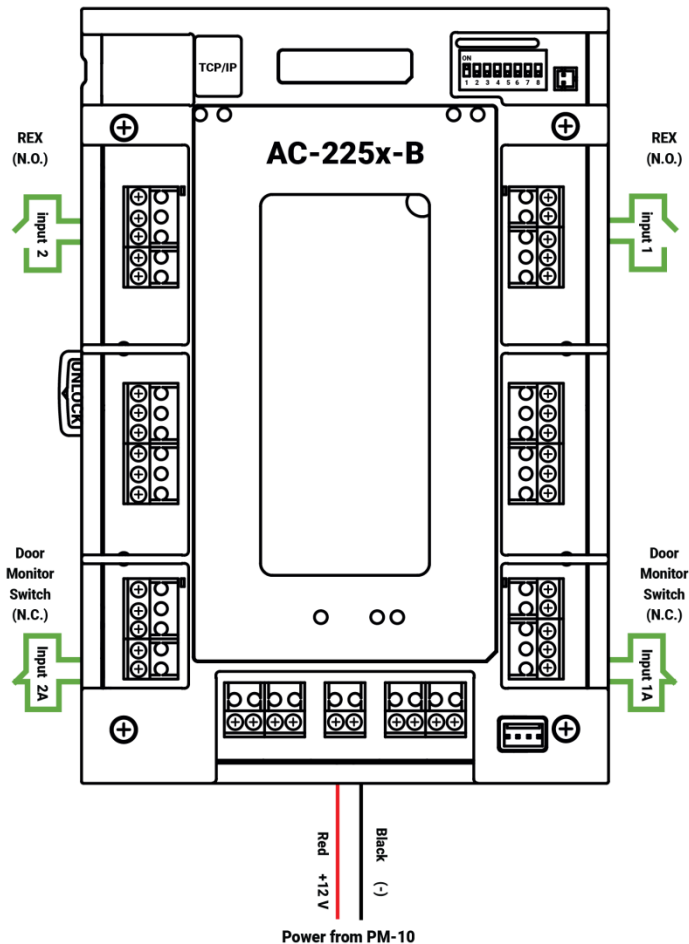

3.2 Inputs Wiring – Supervised Inputs

When wiring the AC-225x for supervised inputs, resistors should be placed on the input switch and not on the terminal block.

For further details, see Chapter 4.

3.3 Outputs Wiring

Figure 4 and Figure 5 illustrate wiring for two main types of 12 VDC electrical release mechanisms. Other electrical devices can be switched using the voltage free relay contacts.

Figure 4: Door Lock – Failed Close

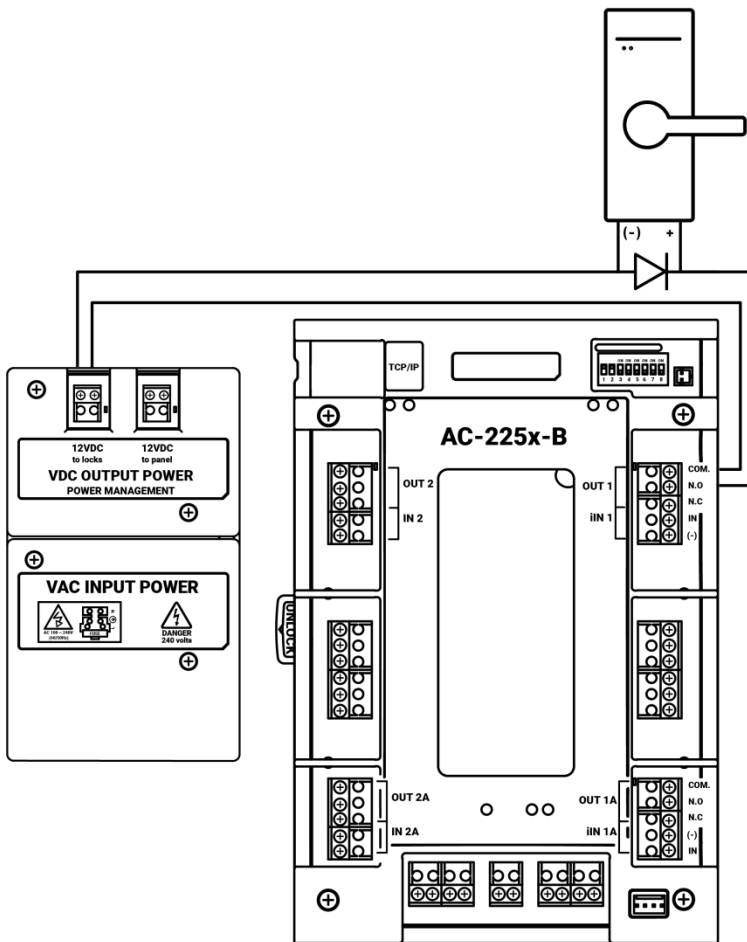
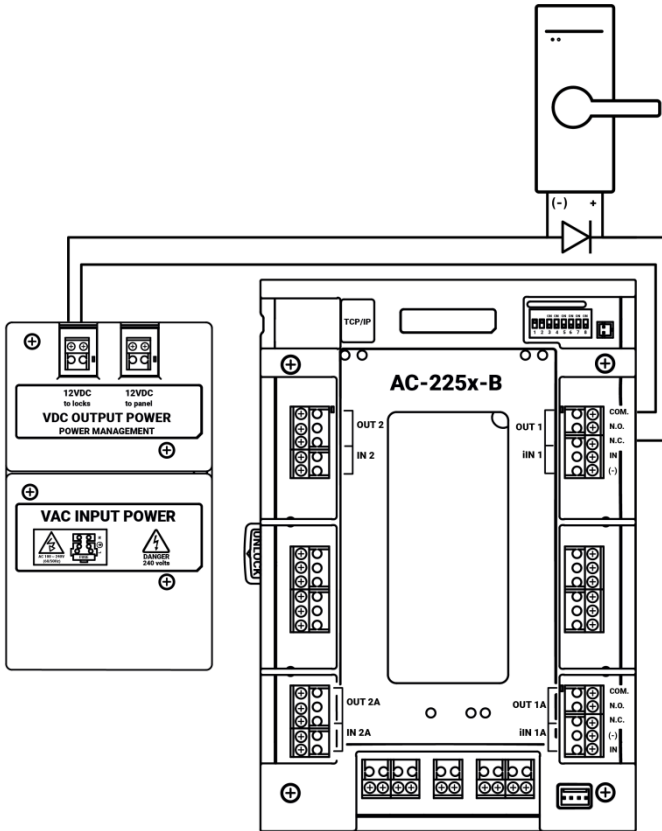

Figure 5: Door Lock – Failed Open



3.4 Power Supply

Figure 6 illustrates wiring between the PM-10 power management board and the AC-225x-B. Make sure the connection polarity is correct, (+) to (+) and (-) to (-). Connect the power to the input power terminals of the control panel. It is recommended to add a 12 VDC lead acid backup battery (requires the ME-1015 Power Management Enclosure) to have uninterrupted operation in case main power supply fails. A 12 V, 7 AH battery provides 3 hours of backup operation.

Figure 6: Wiring Between PM-10 and AC-225x-B

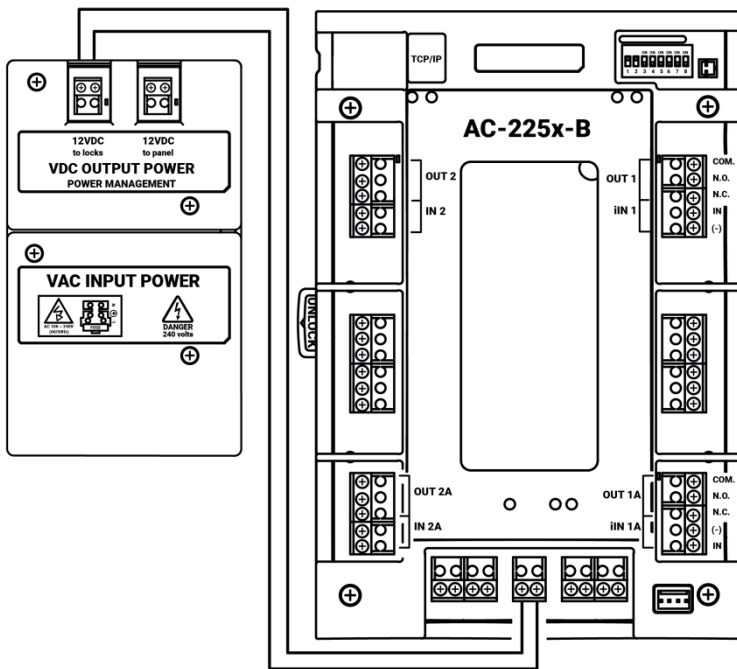

3.5 AC-225x-B Wiring Communications

Figure 7 presents a detailed view of the access control panel with all its necessary wiring for communications.

Figure 7: AC-225x-B Wiring Communications

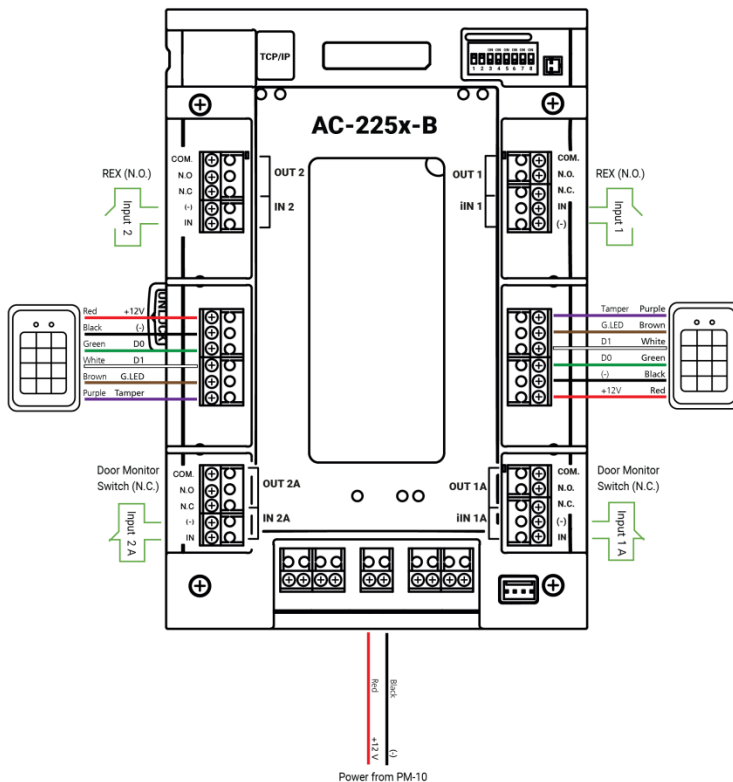

3.6 Reader

Readers are supplied with a limited cable length. When extending the wire, make sure to match the conductors to the correct terminals on the AC-225x-B panel (Figure 8).

Refer to the reader specifications for the maximum cable length (typically 150 m with an 18 AWG cable).

Figure 8: Reader Wiring

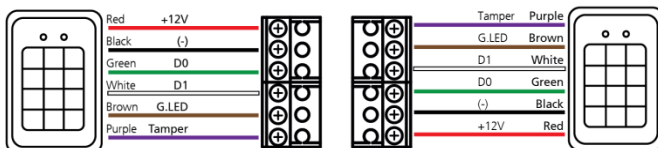

3.7 MD-IO84B

The MD-IO84 is an optional I/O expansion board which adds four relay outputs and eight supervised inputs to the access control panel. Attach the MD-IO84B to the AC-225x-B's expansion slot, as marked in red in Figure 9.

Figure 9: Connector Location for MD-IO84B or MD-D02B Expansions

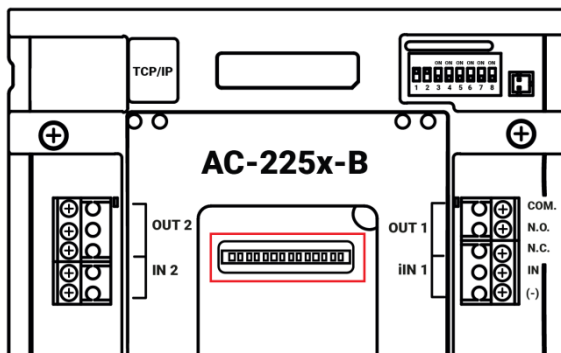

For more information, see the *MD-IO84B Installation and User Guide*.

3.8 MD-D02B

The MD-D02B is an optional reader expansion board which adds two readers, four relay outputs and four supervised inputs to the access control panel. Attach the MD-D02B to the AC-225x-B's expansion slot, as marked in red in Figure 9.

For more information, see the *MD-D02B Installation and User Guide*.

4. Input and Output Connections

This chapter describes the AC-225x-B access control panel's input and output connections.

4.1 Input Types

There are four input types – Normally Open, Normally Closed, Normally Open Supervised 1 or 2 resistors, and Normally Closed Supervised 1 or 2 resistors.

Inputs IN1, IN1A, IN2 and IN2A may be configured individually as either supervised or non-supervised inputs. Configure each input separately via the AxTraxNG/AxTraxPro Access Control Management Software.

Non-supervised inputs have two states:

- Normal State
- Abnormal State

Supervised inputs have three states:

- Normal State
- Abnormal State
- Trouble State

The Trouble state is caused by either tampering with the input circuit or by faulty hardware installation. Once configured as supervised input, add a resistor of 2.2 k Ω , of 8.2 k Ω or both on the input circuit. See the figures in the following subsections.

4.1.1 Normally Open Input Connection

Normally Open Input has 2 states:

- Switch Open – Normal State:
Loop resistance = Infinite (open circuit).
- Switch Closed – Abnormal State:
Loop resistance = 0 (short circuit)

Figure 10: Normally Open Input Connection



4.1.2 Normally Closed Input Connection

Normally Closed Input has two states:

- Switch Closed – Normal State:
Loop resistance = 0 (short circuit).
- Switch Open – Abnormal State:
Loop resistance = Infinite (open circuit).

Figure 11: Normally Closed Input Connection

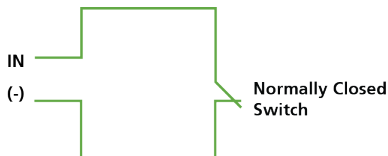

4.1.3 Normally Open Supervised Single Resistor Input Connection

Connect an 8.2 k Ω resistor in parallel to the input switch contacts.

Normally Open Supervised Input has 3 states:

- Switch Open – Normal State:
Loop resistance = 8.2 k Ω
- Switch Closed – Abnormal State:
Loop resistance = 0 (short circuit).
- Open circuit across input terminals – Trouble State:
Loop resistance = Infinite (open circuit).

Figure 12: Normally Open Supervised Input Connection (Single Resistor)

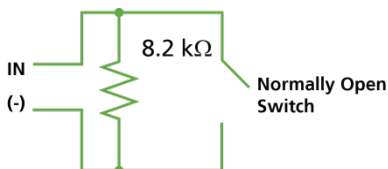

4.1.4 Normally Open Supervised Double Resistor Input Connection

Connect a 2.2 k Ω resistor in series to the input switch contacts.

Connect an 8.2 k Ω resistor parallel to the input switch contacts.

Normally Open Supervised Input has 3 states:

- Switch Open – Normal State:
Loop resistance = 10.4 k Ω
- Switch Closed – Abnormal State:
Loop resistance = 2.2 k Ω

- Open circuit (infinite loop resistance) or short circuit (0 resistance) across input terminals – Trouble State.

Figure 13: Normally Open Supervised Input Connection (Double Resistor)

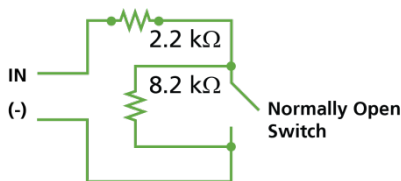

4.1.5 Normally Closed Supervised Single Resistor Input Connection

Connect a 2.2 kΩ resistor in series to the input switch contacts.

Normally Closed Supervised Input has 3 states:

- Switch Closed – Normal State:
Loop resistance = 2.2 kΩ
- Switch Open – Abnormal State:
Loop resistance = Infinite (open circuit)
- Short circuit across input terminals – Trouble State:
Loop resistance = 0 (short circuit)

Figure 14: Normally Closed Supervised Input Connection (Single Resistor)

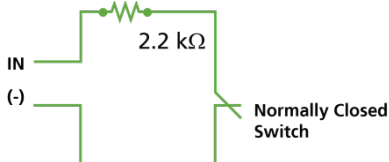

4.1.6 Normally Closed Supervised Double Resistor Input Connection

Connect a 2.2 k Ω resistor in series to the input switch contacts.

Connect an 8.2 k Ω resistor parallel to the input switch contacts.

Normally Closed Supervised Input has 3 states:

- Switch Closed – Normal State:
Loop resistance = 2.2 k Ω
- Switch Open – Abnormal State:
Loop resistance = 10.4 k Ω
- Open circuit (Infinite loop resistance) or short circuit (0 resistance) across input terminals – Trouble State

Figure 15: Normally Closed Supervised Input Connection (Double Resistor)

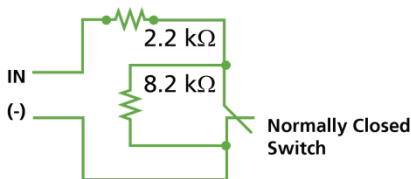

4.2 Inputs Description

4.2.1 Request-to-Exit (REX) Button Input

Use the REX input to open a door directly. Typically, the REX input is connected to a Normally Open push button that is located inside the premises. The push button is generally located in an easy-to-access position and opens a door without reading a proximity card or PIN code.

Single door controller:	Door 1 – IN1
Double door controller:	Door 1 – IN 1 Door 2 – IN 2

REX input functions when using MD-D02B:

Double door controller: (each door has two readers)	Door 1 – IN1 Door 2 – IN5
Four door controller (each door has one reader)	Door 1 – IN1 Door 2 – IN2 Door 3 – IN5 Door 4 – IN7

4.2.2 Door Monitor Input

The Door Monitor input typically connects to a Normally Closed door sensing micro-switch for door status monitoring. Using Door Monitor enables many

Input and Output Connections

advanced options such as door forced alarm, door held open warnings, interlocking doors and more. The following should be defined:

Single door controller:	Door 1 – IN1A
Double door controller:	Door 1 – IN1A Door 2 – IN2A

Dedicated input functions when using MD-D02B:

Double door controller: (each door has two readers)	Door 1 – IN1A Door 2 – IN6
Four door controller: (each door has one reader)	Door 1 – IN1A Door 2 – IN2A Door 3 – IN6 Door 4 – IN8

4.2.3 General Purpose Inputs

These are free inputs that can be used for various functions. The following should be defined:

Single door controller:	Door 1 – IN2 Door 1 – INA
Double door controller:	No general-purpose inputs available

General purpose inputs are suitable for most uses. For example, they might be used to detect tampering, to activate alarm sensors or for monitoring power supply failure.

General purpose input functions when using MD-IO84B or MD-D02B:

MD-IO84B:	IN5 to IN12
MD-D02B:	IN5 to IN8 except the dedicated inputs

4.3 Outputs

Rosslare Security recommends the use of suppression diodes for all outputs that activate an inductive load.

Door Lock

There are two types of door locking devices:

- Fail open (fail secure)
- Fail close (fail safe)

The following should be defined:

Single door controller:	Door 1 – OUT 1
Double door controller:	Door 1 – OUT 1 Door 2 – OUT 2

Door outputs when using MD-D02B:

Input and Output Connections

Double door controller: (each door has two readers)	Door 1 – OUT 1 Door 2 – OUT 5
Four door controller: (each door has one reader)	Door 1 – OUT 1 Door 2 – OUT 2 Door 3 – OUT 5 Door 4 – OUT 7

The output can sink current from any power supply (see Section 3.4).

4.4 Card Readers and Keypads

Each access control panel can be connected to a maximum of two readers or four readers when using MD-D02B. There are three available types of reader:

- Card readers
- Keypads
- Dual keypad card readers

A keypad is required for any reader mode that requires PIN code entries, such as "Card or PIN", "PIN Only" or "Card and PIN (Secured mode)".

When connecting a reader, the following should be defined:

Single door controller:	Door 1 – Reader 1 IN/OUT Door 1 – Reader 2 OUT/ IN
Double door controller:	Door 1 – Reader 1 IN/OUT Door 2 – Reader 2 IN/OUT

When using the MD-D02B, the following should be defined:

Double door controller: (each door has two readers)	Reader 1 – Door 1 IN/OUT Reader 2 – Door 1 OUT/IN Reader 3 – Door 2 IN/OUT Reader 4 – Door 2 OUT/IN
Four door controller: (each door has one reader)	Reader 1 – Door 1 IN/OUT Reader 2 – Door 2 IN/OUT Reader 3 – Door 3 IN/OUT Reader 4 – Door 4 IN/OUT

Use the AxTraxNG/AxTraxPro Access Control Management Software to set the readers for IN or OUT use and to set the data transmission format for each reader.

The reader's tamper output connects to the access control panel's Reader-Tamper input. If the reader is interfered with, an alarm can be generated.

The panel's Reader G.LED output activates the reader's green LED input when operating in "Card and PIN" secure mode. While this mode is in force, users must enter a PIN on the keypad immediately after entering the card.

Input and Output Connections

The controller activates the LED control for 2 seconds when an access granted event occurs.

5. AC-225x-B Hardware Settings

5.1 DIP Switch Configuration

The DIP switches in the access control panel determine the baud rates for serial communication, control panel type, and the device address, as summarized in Table 2.

Table 2: DIP Switches and Their Functions

DIP Switch	Function
1	The panel's communication baud rate
2	
3	The panel type defines the number of readers for each door – one or two readers per door. This also affects the number of doors controlled by the panel.
4	The access control panel's RS-485 network address
5	
6	
7	
8	



Note

Power down the access control panel before changing the DIP switch settings. After changes have been made, restart the panel. The new settings are automatically defined after power up.

In general, the up position is ON and the down position is OFF as demonstrated in Figure 16.

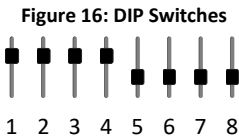

5.2 Access Control Panel Baud Rate

The access control panel serial port baud rate, set in DIP switches one and two, defines the communication speed for connecting with a PC in a network connection. The default baud rate is set to 9600 bits per second.

Table 3 lists Switch 1 and 2 status and baud rate:

Table 3: Switch Baud Rates

Switch 1	Switch 2	Baud Rate
OFF	OFF	9600
OFF	ON	19200
ON	OFF	115200
ON	ON	57600



The access control panel baud rate must be identical to the AxTraxNG/AxTraxPro Network configuration of baud rate.

5.3 Access Control Panel Type

The access control panel type is defined using the third DIP switch. There are two panel types – a panel with one reader for each door or a panel with two readers for each door. This DIP switch setting influences the number of doors in the panel.

The default access control panel setting is two readers for each door.

- **OFF** – Defines using two readers for each door. Panel controls one door or two doors when MD-D02B is installed.
- **ON** – Defines using one reader for each door. Panel controls two doors or four doors when MD-D02B installed.

Select the appropriate DIP switch setting to operate the panel as either a single door, a double door, or four doors (see Section 5.1).

Access control panels configured as either single door or double door controllers have two readers, IN or OUT. Access control panels configured with the MD-D02B expansion as either double door or four-door controllers have four readers.

Table 4 summarizes the possible hardware settings.

Table 4: Possible Hardware Settings

Single Door		
Outputs	Door Lock output	(OUT 1)
	General purpose output	(OUT 1A)
	General purpose output	(OUT 2)
	General purpose output	(OUT 2A)

AC-225x-B Hardware Settings

Inputs	Request to exit	(IN 1)
	Door monitor input	(IN 1A)
	General purpose input	(IN 2)
	General purpose input	(IN 2A)
Readers	Reader1	Door Entry or Exit
	Reader2	Door Exit or Entry

Double Door

Outputs	Door1 Lock output	(OUT 1)
	General purpose output	(OUT 1A)
	Door2 Lock output	(OUT 2)
	General purpose output	(OUT 2A)
Inputs	Door1 Request to exit	(IN 1)
	Door1 monitor input	(IN 1A)
	Door2 Request to exit	(IN 2)
	Door2 monitor input	(IN 2A)
Readers	Reader1	(Door1 IN/OUT)
	Reader2	(Door2 IN/OUT)

Double Door with 4 Readers (MD-D02B)

Outputs	Door1 Lock output	(OUT 1)
	General purpose output	(OUT 1A)
	General purpose output	(OUT 2)
	General purpose output	(OUT 2A)
	Door2 Lock output	(OUT 5)
	General purpose output	(OUT 6)
	General purpose output	(OUT 7)
	General purpose output	(OUT 8)
Inputs	Door1 Request to exit	(IN 1)
	Door1 monitor input	(IN 1A)
	General purpose input	(IN 2)
	General purpose input	(IN 2A)
	Door2 Request to exit	(IN 5)
	Door2 monitor input	(IN 6)
	General purpose input	(IN 7)
	General purpose input	(IN 8)
Readers	Reader1	(Door1 IN/OUT)
	Reader2	(Door1 OUT/IN)
	Reader3	(Door2 IN/OUT)

	Reader4	(Door2 OUT/IN)
Four Door with 4 Readers (MD-D02B)		
Outputs	Door1 Lock output	(OUT 1)
	General purpose output	(OUT 1A)
	Door2 Lock output	(OUT 2)
	General purpose output	(OUT 2A)
	Door3 Lock output	(OUT 5)
	General purpose output	(OUT 6)
	Door4 Lock output	(OUT 7)
	General purpose output	(OUT 8)
Inputs	Door1 Request to exit	(IN 1)
	Door1 monitor input	(IN 1A)
	Door2 Request to exit	(IN 2)
	Door2 monitor input	(IN 2A)
	Door3 Request to exit	(IN 5)
	Door3 monitor input	(IN 6)
	Door4 Request to exit	(IN 7)
	Door4 monitor input	(IN 8)
Readers	Reader1	(Door1 IN/OUT)
	Reader2	(Door2 IN/OUT)
	Reader3	(Door3 IN/OUT)
	Reader4	(Door4 IN/OUT)

5.4 Access Control Panel Addressing

The last five DIP switches are used to set the binary code of the access control panel internal network address. The default access control panel address is “1”.



For successful communications, the DIP switch must match the address set in the AxTraxNG/AxTraxPro Access Control Management Software.

Table 5 displays the 32 address settings available:

Table 5: Available Panel Addresses

Address	Switch 4	Switch 5	Switch 6	Switch 7	Switch 8
1	OFF	OFF	OFF	OFF	OFF
2	OFF	OFF	OFF	OFF	ON
3	OFF	OFF	OFF	ON	OFF
4	OFF	OFF	OFF	ON	ON
5	OFF	OFF	ON	OFF	OFF
6	OFF	OFF	ON	OFF	ON

AC-225x-B Hardware Settings

Address	Switch 4	Switch 5	Switch 6	Switch 7	Switch 8
7	OFF	OFF	ON	ON	OFF
8	OFF	OFF	ON	ON	ON
9	OFF	ON	OFF	OFF	OFF
10	OFF	ON	OFF	OFF	ON
11	OFF	ON	OFF	ON	OFF
12	OFF	ON	OFF	ON	ON
13	OFF	ON	ON	OFF	OFF
14	OFF	ON	ON	OFF	ON
15	OFF	ON	ON	ON	OFF
16	OFF	ON	ON	ON	ON
17	ON	OFF	OFF	OFF	OFF
18	ON	OFF	OFF	OFF	ON
19	ON	OFF	OFF	ON	OFF
20	ON	OFF	OFF	ON	ON
21	ON	OFF	ON	OFF	OFF
22	ON	OFF	ON	OFF	ON
23	ON	OFF	ON	ON	OFF
24	ON	OFF	ON	ON	ON
25	ON	ON	OFF	OFF	OFF
26	ON	ON	OFF	OFF	ON
27	ON	ON	OFF	ON	OFF
28	ON	ON	OFF	ON	ON
29	ON	ON	ON	OFF	OFF
30	ON	ON	ON	OFF	ON
31	ON	ON	ON	ON	OFF
32	ON	ON	ON	ON	ON

6. Communications

Communication lines are used to upload and download information between the access control panel and the AxTraxNG/AxTraxPro Access Control Management Software. When the access control panel and the computer are communicating, the system's two LEDs flash accordingly.

- The RX LED flashes when the controller receives data.
- The TX LED flashes when the controller transmits data.



Note

The access control panel address is defined in the AxTraxNG/AxTraxPro Access Control Management Software. It is important that the DIP switch and the software are set to the same address.

There are three connection modes:

- Serial Network (RS-232 or RS-485)
- Modem Network
- TCP/IP Network

6.1 Serial Network Connection

The computer serial port controlling the access control panel is set from within the AxTraxNG/AxTraxPro Access Control Management Software. The default bitrate is 9600 bps for direct connection to the computer.

When using an RS-232 connector, only one access control panel can be linked to each communication port on the computer. Use an RS-485 connection if you wish to connect additional panels to the primary control panel already connected to the COM port.



Note

The J1 switch must be in the correct position to select the RS-232 communication.

6.1.1 RS-232 Connection to the Computer

Set the J1 switch/jumper to the RS-232 position.

The RS-232 connection can only connect a single access control panel to the computer (Figure 17).

Figure 17: RS-232 Panel Connection to PC

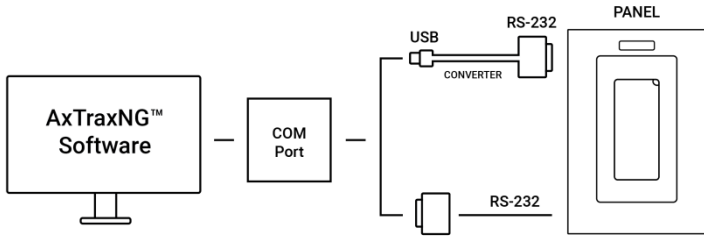

The distance between the computer and the access control panel must be no more than 150 feet (50 meters).

If the baud rate is increased to 57600 or beyond, the distance must be no more than 30 feet (10 meters).

Table 6: RS-232 Connection

Access Control Panel	DB9 Connector	DB25 Connector
GND	Pin 5	Pin 7
Tx	Pin 2	Pin 3
Rx	Pin 3	Pin 2

6.1.2 RS-485 Connection to the Computer

Set the J1 switch/jumper to the RS-485 position.

Using the RS-485, up to 32 access control panels can be linked together and connected to a single communication port on the computer (Figure 18).

Figure 18: RS-485 Panel Connection to PC

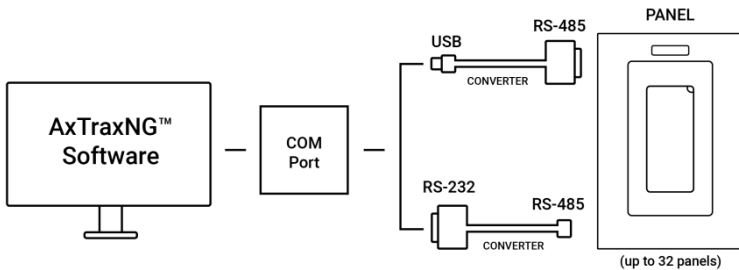

Use the RS-485 interface for situations where there are multiple controllers connected. The serial port used to control the access control panel is assigned within the AxTraxNG/AxTraxPro Access Control Management Software.

The AC-225x-B supports the 2-wire RS-485 interface, which can significantly increase the distance between the server and the last panel. To use the RS-485 interface, the panels must be connected in a daisy-chain formation with an MD-14U RS-485 to RS-232 adapter (Section 6.1.3).

 The recommended cable type to be used is STP cat5 (shielded twisted pair category 5). We recommend using a 20-24-AWG cable.

6.1.3 Daisy Chaining

You can connect up to 32 panels to a single serial line using a daisy-chain formation, which is done by drop-down RS-485 wiring (Figure 19).

Figure 19: Daisy Chaining

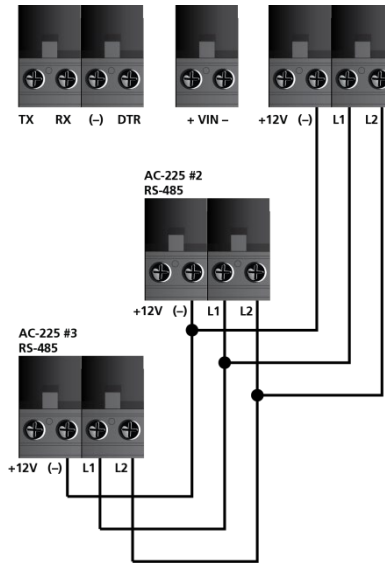

This can increase the maximum distance from the PC to the last panel in the chain to 4,000 ft (1,219.2 m).

The first panel is connected directly to the server using an MD-14U converter, while the second panel connects to the first panel. Additional panels are connected in the same way, one after another. The server identifies each panel on the RS-485 network by its address.

At each end of the data line, both where the panel connects to the computer and on the last panel in the network, a termination resistor of 100–120 Ω may be required. Apply the resistor across the L1 and L2 connections.

 These termination resistors are especially important in long cable runs.

6.2 TCP/IP Network Connection

 This section applies to the AC-225IP models only.
 Note

The computer running the AxTraxNG/AxTraxPro Access Control Management Software can communicate with the access control panels via a TCP/IP network. The connection settings are controlled within the AxTraxNG/AxTraxPro Access Control Management Software.

The AC-225IP panels connect to the TCP/IP network (LAN or WAN) directly, using an onboard network module. For each AC-225IP panel connected on a TCP/IP port, up to 31 subnetted panels can be connected via an RS-485 bus, which means that one IP port can support up to 32 AC-225x-B panels (Figure 20).

Figure 20: Connecting Multiple Access Control Panels to AC-225IP

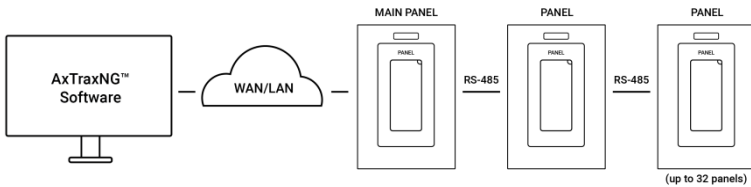

To connect to a TCP/IP network using AC-225 non-IP models, add Rosslare's MD-N32 TCP/IP to RS-232 gateway converter.

 For more information on operating an MD-N32, refer to the *MD-N32 User Manual*.
 Note

6.2.1 LAN and WAN Requirements

The devices can be connected to a TCP/IP network using any valid network address.

Use a TCP/IP connection when a LAN network already exists. Figure 21 illustrates the connection of a single AC-225x-B to a computer via a LAN network.

Figure 21: Connecting a Single Control Panel with MD-N32

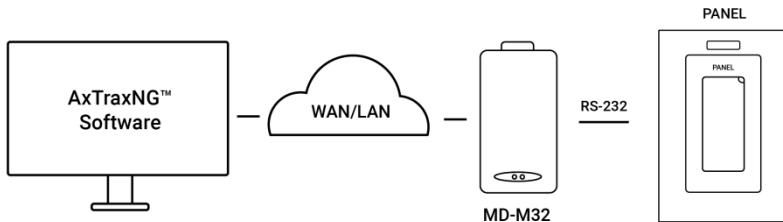

The maximum distance from the Ethernet port of the panel to the LAN/WAN connection is 100 m (330 ft).

When the TCP/IP connection is implemented over a WAN, it becomes possible to connect through the Internet. This makes it possible to control multiple access control panels worldwide, all from a single computer.

Before connecting a panel by TCP/IP connection for the first time, the AxTraxNG/AxTraxPro Access Control Management Software must configure the device. Settings then remain stored in non-volatile memory on the device (see the *AxTraxNG User Guide* or the *AxTraxPro User Guide*).

When using an MD-N32, for a single panel, either an RS-232 cable or Rosslare's MD-14U RS-485 to RS-232 converter can be used.

To connect an MD-N32 to more than one panel (up to 32 panels), Rosslare's MD-14U RS-485 to RS-232 converter must be used. Connect the MD-14U between the RS-485 access control panel network and the MD-N32 converter (Figure 22).

Figure 22: Connecting Multiple Access Control Panels with MD-N32

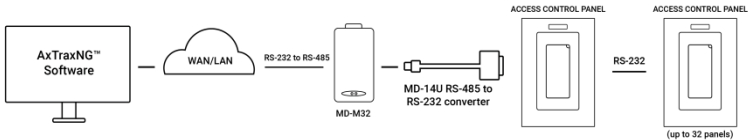

A. Declaration of Conformity

FCC ID = GCD-AC225x

- This device complies with Part 15 of the FCC Rules. Operation is subject to the following two conditions:
 - This device may not cause harmful interference.
 - This device must accept any interference received, including interference that may cause undesired operation.
- Changes or modifications not expressly approved by the party responsible for compliance could void the user's authority to operate the equipment.

This equipment has been tested and found to comply with the limits for a Class B digital device, pursuant to part 15 of the FCC Rules. These limits are designed to provide reasonable protection against harmful interference in a residential installation. This equipment generates, uses, and can radiate radio frequency energy and, if not installed and used in accordance with the instructions, may cause harmful interference to radio communications. However, there is no guarantee that interference will not occur in a particular installation. If this equipment does cause harmful interference to radio or television reception, which can be determined by turning the equipment off and on, the user is encouraged to try to correct the interference by one or more of the following measures:

- Reorient or relocate the receiving antenna.
- Increase the separation between the equipment and receiver.
- Connect the equipment into an outlet on a circuit different from that to which the receiver is connected.
- Consult the dealer or an experienced radio/TV technician for help.

B. Radio Equipment Directive (RED)

Under our sole responsibility that the following labeled AC-225-Bx, AC-225-DIN, AC-225IP-Bx, and AC-225IP-DIN are tested to conform to the EU Radio Equipment Directive – RED 2014/53/EU – in electrical and electronic equipment.

C. RoHS Directive

Under our sole responsibility that the following labeled AC-225-Bx, AC-225-DIN, AC-225IP-Bx, and AC-225IP-DIN are tested to conform to the Restriction of Hazardous Substances (RoHS) directive – 2011/65/EU – in electrical and electronic equipment.

D. UL 294 7th Edition

The following labeled AC-225-Bx, AC-225-DIN, AC-225IP-Bx, and AC-225IP-DIN are UL listed to UL 294 7th Edition Standard for Access Control System Units.

Table 7: UL 294 Access Control Performance Ratings

Destructive Attack	Level I
Endurance	Level IV
Line Security	Level I
Standby Power	Level II

E. Limited Warranty

The full ROSSLARE Limited Warranty Statement is available in the Quick Links section on the ROSSLARE website at www.rosslaresecurity.com.

Rosslare considers any use of this product as agreement to the Warranty Terms even if you do not review them.



Asia Pacific, Middle East, Africa

Rosslare Enterprises Ltd.
Kowloon Bay, Hong Kong
Tel: +852 2795-5630
Fax: +852 2795-1508
support.apac@rosslaresecurity.com

United States and Canada

Rosslare Security Products, Inc.
Southlake, TX, USA
Toll Free: +1-866-632-1101
Local: +1-817-305-0006
Fax: +1-817-305-0069
support.na@rosslaresecurity.com

Europe

Rosslare Israel Ltd.
22 Ha'Melacha St., P.O.B. 11407
Rosh HaAyin, Israel
Tel: +972 3 938-6838
Fax: +972 3 938-6830
support.eu@rosslaresecurity.com

Latin America

Rosslare Latin America
Buenos Aires, Argentina
Tel: +54-11-4001-3104
support.la@rosslaresecurity.com

China

Rosslare Electronics (Shenzhen) Ltd.
Shenzhen, China
Tel: +86 755 8610 6842
Fax: +86 755 8610 6101
support.cn@rosslaresecurity.com

India

Rosslare Electronics India Pvt Ltd.
Tel/Fax: +91 20 40147830
Mobile: +91 9975768824
sales.in@rosslaresecurity.com

ROSSLARE
Secure Access Solutions

