

SAMSUNG
WiSeNET

NETWORK VIDEO RECORDER

User Manual

XRN-1610S/1610

CE

Network Video Recorder

User Manual

Copyright

©2016 Hanwha Techwin Co., Ltd. All rights reserved.

Trademark

Each of trademarks herein is registered. The name of this product and other trademarks mentioned in this manual are the registered trademark of their respective company.

Restriction

Copyright of this document is reserved. Under no circumstances, this document shall be reproduced, distributed or changed, partially or wholly, without formal authorization.

Disclaimer

Hanwha Techwin makes the best to verify the integrity and correctness of the contents in this document, but no formal guarantee shall be provided. Use of this document and the subsequent results shall be entirely on the user's own responsibility. Hanwha Techwin reserves the right to change the contents of this document without prior notice.

❖ Design and specifications are subject to change without prior notice.

❖ The initial administrator ID is "admin" and the password should be set when logging in for the first time.

Please change your password every three months to safely protect personal information and to prevent the damage of the information theft.

Please, take note that it's a user's responsibility for the security and any other problems caused by mismanaging a password.

IMPORTANT SAFETY INSTRUCTIONS

Read these operating instructions carefully before using the unit.
Follow all the safety instructions listed below.
Keep these operating instructions handy for future reference.

- 1) Read these instructions.
- 2) Keep these instructions.
- 3) Heed all warnings.
- 4) Follow all instructions.
- 5) Do not use this apparatus near water.
- 6) Clean the contaminated area on the product surface with a soft, dry cloth or a damp cloth.
(Do not use a detergent or cosmetic products that contain alcohol, solvents or surfactants or oil constituents as they may deform or cause damage to the product.)
- 7) Do not block any ventilation openings, Install in accordance with the manufacturer's instructions.
- 8) Do not install near any heat sources such as radiators, heat registers, stoves, or other apparatus (including amplifiers) that produce heat.
- 9) Do not defeat the safety purpose of the polarized or grounding- type plug. A polarized plug has two blades with one wider than the other. A grounding type plug has two blades and a third grounding prong. The wide blade or the third prong are provided for your safety. If the provided plug does not fit into your outlet, consult an electrician for replacement of the obsolete outlet.
- 10) Protect the power cord from being walked on or pinched particularly at plugs, convenience receptacles, and the point where they exit from the apparatus.
- 11) Only use attachments/accessories specified by the manufacturer.
- 12) Use only with the cart, stand, tripod, bracket, or table specified by the manufacturer, or sold with the apparatus. When a cart is used, use caution when moving the cart/apparatus combination to avoid injury from tip-over.
- 13) Unplug this apparatus during lightning storms or when unused for long periods of time.
- 14) Refer all servicing to qualified service personnel. Servicing is required when the apparatus has been damaged in any way, such as power-supply cord or plug is damaged, liquid has been spilled or objects have fallen into the apparatus, the apparatus has been exposed to rain or moisture, does not operate normally, or has been dropped.



Standards Approvals



- 
 This equipment has been tested and found to comply with the limits for a Class A digital device, pursuant to part 15 of the FCC Rules. These limits are designed to provide reasonable protection against harmful interference when the equipment is operated in a commercial environment.
This equipment generates, uses, and can radiate radio frequency energy and, if not installed and used in accordance with the instruction manual, may cause harmful interference to radio communications. Operation of this equipment in a residential area is likely to cause harmful interference in which case the user will be required to correct the interference at his own expense.

BEFORE START

This manual provides operational information necessary for using the product and contains a description about each component part and its function as well as menu or network settings.
You have to keep in mind the following notices :

- Hanwha Techwin retains the copyright on this manual.
- This manual cannot be copied without Hanwha Techwin's prior written approval.
- We are not liable for any or all losses to the product incurred by your use of non-standard product or violation of instructions mentioned in this manual.
- Prior to opening the case, please consult a qualified technician first. Whenever this is needed power must be removed from the unit.
- Before adding a hard disk drive or external storage (USB memory, USB HDD, etc), check if it is compliant with this product. For the compatibility list, contact the retailer.

Warning

Battery

It is essential that when changing the battery in the unit, the replacement battery must be of the same type otherwise there may be a possibility of an explosion.

The following are the specifications of the battery you are using now.

- Normal voltage : 3V
- Normal capacity : 210mAh
- Continuous standard load : 0.4mA
- Operating temperature : -20°C ~ +60°C
(-4°F ~ +140°F)

CALIFORNIA USA ONLY

This Perchlorate warning applies only to primary CR (Manganese Dioxide) Lithium coin cells in the product sold or distributed ONLY in California USA.
"Perchlorate Material - special handling may apply.
See www.dtsc.ca.gov/hazardouswaste/perchlorate."

Caution

- Connect the power cord into a grounded outlet.
- The Mains plug is used as a disconnect device and shall stay readily operable at any time.
- Batteries shall not be exposed to excessive heat such as sunshine, fire or the like.
- Risk of Explosion if Battery is replaced by an Incorrect Type. Dispose of Used Batteries According to the Instructions.

System Shutdown

Turning off the power while the product is in operation, or undertaking improper actions may cause damage or malfunction to the hard drive or the product.

To safely turn off the power, check <OK> in the system termination pop up window and then remove the power chord.

You may want to install a UPS system for safe operation in order to prevent damage caused by an unexpected power stoppage. (Any questions concerning UPS, consult your UPS retailer.)



- If powered off abnormally, restarting may take more time for restoring data from hard disk drive for proper operation.

Operating Temperature

The guaranteed operating temperature range of this product is 0°C ~ 40°C (32°F ~ 104°F).

This product may not work properly if you run right after a long period of storage at a temperature below the guaranteed one.

Prior to using a device that has been stored for a long period in low temperatures, allow the product to stand at room temperature for a period.

Especially for the built-in HDD in the product, its guaranteed temperature range is 5°C ~ 55°C (41°F ~ 131°F).

Likewise, the hard drive may not work at a temperature below the guaranteed one.

Ethernet Port

This equipment is in door use and all the communication wirings are limited to inside of the building.

Security Precautions

The initial administrator ID is “**admin**” and the password should be set when logging in for the first time.

Please change your password every three months to safely protect personal information and to prevent the damage of the information theft.

Please, take note that it's a user's responsibility for the security and any other problems caused by mismanaging a password.

CONTENTS

OVERVIEW	3	Important Safety Instructions
	3	Before Start
	5	Contents
	6	Features
	7	Part Names and Functions (Front)
	7	Part Names and Functions (Rear)
	8	Remote Control

INSTALLATION	9	Checking the installation environment
	9	Rack Installation
	10	HDD Addition

CONNECTING WITH OTHER DEVICE	12	Connecting to an external device
	12	Connecting the USB
	12	Connecting the Alarm Input/Output
	13	Connecting the Network

LIVE	15	Getting Started
	16	Live Screen Configuration
	19	Live Screen Mode
	21	Zoom
	22	PoE Status (XRN-1610S)
	22	Layout
	23	Audio ON/OFF
	23	Freeze
	23	Event Monitoring
	23	Capture
	24	Maintain the Screen Ratio
	24	Display Text
	24	PTZ control
	26	Backup

MENU SETUP	27	System Setup
	32	Setting the Device
	41	Setting the Recording
	43	Setting the Event
	45	Network Configuration

SEARCH & PLAY	50	Search
	52	Playback

STARTING WEB VIEWER	53	What is Web Viewer?
	53	Connecting Web Viewer

LIVE VIEWER	55	Live Viewer
	56	Live Screen Configuration
	59	Controlling a Connected Network Camera

SEARCH VIEWER	61	Search Viewer
----------------------	-----------	---------------

SETUP VIEWER	64	Setup Viewer
---------------------	-----------	--------------

BACKUP VIEWER	73	SEC Backup Viewer
----------------------	-----------	-------------------

APPENDIX	74	Product Specification
	76	Product Overview
	77	Default Setting
	78	Troubleshooting
	81	Open Source License Report on the Product



FEATURES









The product records video and audio from network cameras to a hard disk, and enables playback from the hard disk. It also provides remote monitoring environment for video and audio over the network using a remote computer.

- User-friendly UI
- Supports a range of 4K camera resolutions (3840X2160, 4096X2160, 4000X3000)
- Outputs a 4K high definition image using HDMI
- Record and play video
- Record and play audio
- Supports ONVIF Profile S standard and RTP / RTSP protocols
- Display the HDD operation status by HDD SMART
- HDD overwrite enabled
- Backup using USB 2.0, 3.0 protocols and external HDD
- Simultaneous play of 16 channels
- Various Search Modes (Time, Event, Text, Backup, ARB)
- Various Recording Modes (Normal, Event, Scheduled Recording)
- Alarm Input / Output
- Remote Monitoring function by Windows Network Viewer
- Live monitoring of the network camera
- Installation Wizard Function (Easy Setup, Quick Setup)

Package Contents

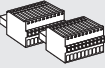
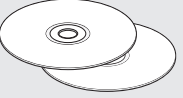
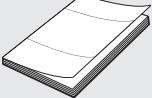
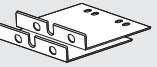
Please unwrap the product, and place the product on a flat place or in the place to be installed. Please check the following contents are included in addition to the main unit.

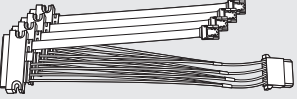
-  The appearance of the components may differ from the image shown.
-  Accessory category and quantity may differ depending on sales region.
-  For some regions, HDD is not pre-installed. HDD Fixing Screw, SATA Power Cable, SATA data cable and SATA power/data cable quantity vary depending on the model.

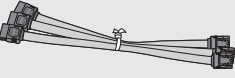
		
NVR	Mouse	
		
Power Cable	Terminal block	Remote Control / Remote Control Battery (AAA)
		
Network Viewer Software / User Manual CD	User Manual or Quick Manual	Bracket Rack
		
HDD Fixing Screw	Bracket Fixing Screw	HDD SATA/Power cable (XRN-1610)
		
SATA Power Cable (XRN-1610S)	SATA Data Cable (XRN-1610S)	

PART NAMES AND FUNCTIONS (FRONT)

XRN-1610S, XRN-1610

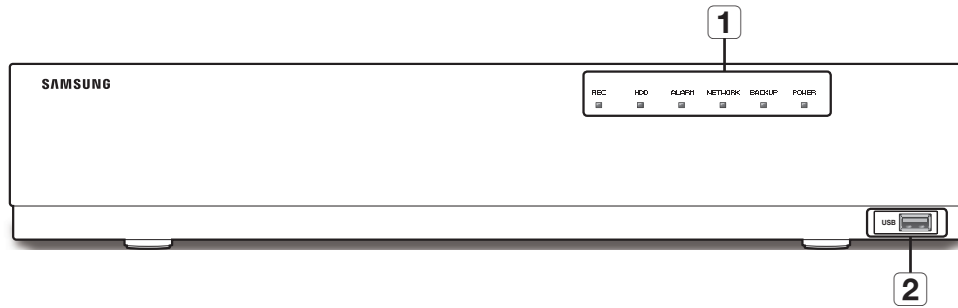

Part Names	Functions
1 LED Indicator	<p>REC : Lights on when recording is in progress.</p> <p>HDD : Displays the normal access to HDD. LED turns on when accessing the hard disk.</p> <p>ALARM : Lights on when an event occurs.</p> <p>NETWORK : Displays both network connection and data transfer status.</p> <p>BACKUP : Stays ON when backup is in operation.</p> <p>POWER : Shows the power ON/OFF status.</p>
2 USB	Connects the USB devices. (USB 2.0 supported)

PART NAMES AND FUNCTIONS (REAR)

XRN-1610

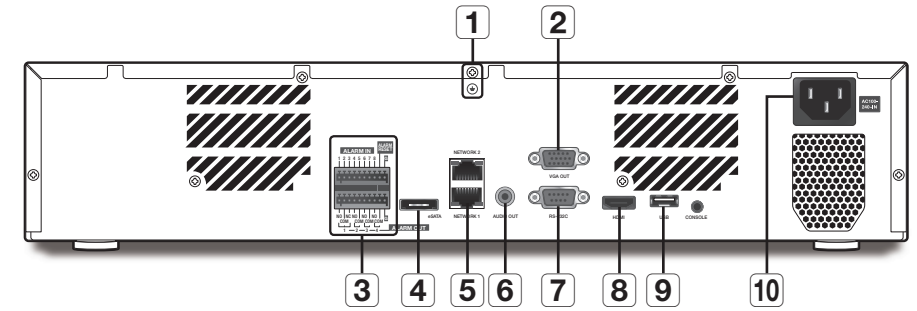

XRN-1610S

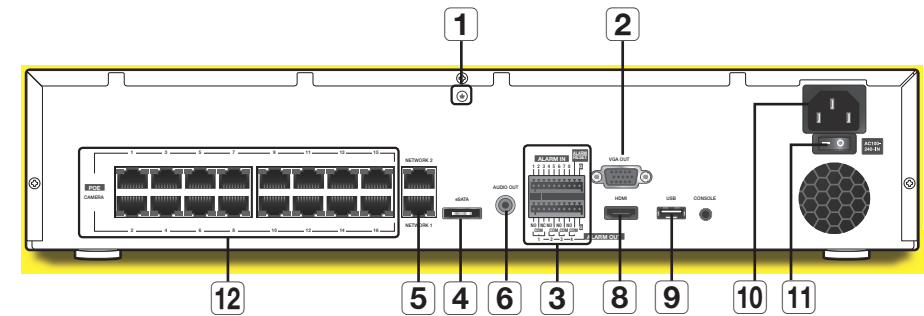

Part Names	Functions
1 Ground connection	Terminal to connect a separate ground cable. <ul style="list-style-type: none"> ▪ Add a ground cable to support the safe use of the device.
2 VGA OUT	VGA Video Signal Output Port.
3 ALARM	<ul style="list-style-type: none"> - ALARM IN : Alarm input ports. (1~8 CH) - ALARM RESET : Alarm Reset port - ALARM OUT : Alarm output ports. (1~4 CH)
4 eSATA	Terminal to connect an external storage device.
5 NETWORK1	Port recommended for camera connection, which receives an image from the camera.
5 NETWORK2	Port recommended for connection with a network, web viewer or iSCSI.
6 AUDIO OUT	Audio Signal Output Port (RCA jack).
7 RS-232C	Cable terminal for serial communication (spare). (XRN-1610)
8 HDMI	HDMI connector port.
9 USB	Connects the USB devices. (USB 3.0 supported)
10 Power	Terminal to connect power to.
11 Power Switch	Power on/off switch.(XRN-1610S)
12 PoE (CAMERA)	Power supply port to connect to a camera. (XRN-1610S)

[CONSOLE] is designed for the service repair purpose only.

REMOTE CONTROL

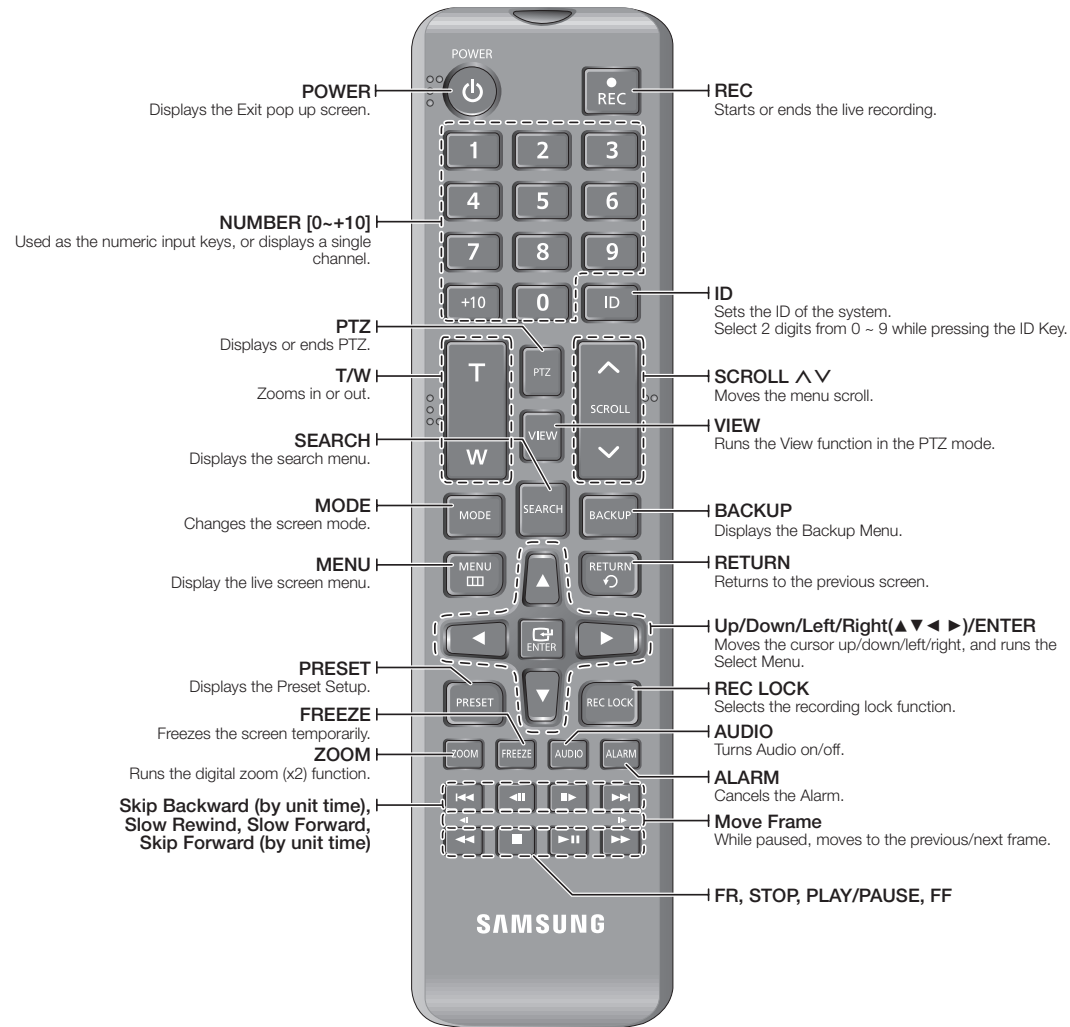

Using the Numeric buttons

CHANNEL 1-9	Press each button between 1 to 9.
CHANNEL 10	Press the [+10] button first, then press the 0 button again within 3 seconds.
CHANNEL 11-16	Press the [+10] button first, then press any number between 1 to 6 within 3 seconds.

Changing the Remote Control ID

Remote control's ID and NVR's ID should be matched for proper operation.

1. Press the [ID] button of the remote control and check the ID displayed on the NVR screen. The factory default ID of the remote control is 00.
2. Enter 2 digits of your selection in order, while pressing the [ID] button of the remote control.
3. When ID input is done, press the [ID] button of the remote control again to check the setting.

- If you want to change the remote control ID to 08: Press 0 and 8 in order while the [ID] button of the remote control is pressed. For changing the ID of remote device, refer to "Remote Devices". (Page 39)

installation

Please take note of the followings before using this product.

- Do not use the product outdoor.
- Do not spill water or liquid in the connection part of the product.
- Do not impose the system to excessive shock or force.
- Do not pull out the power plug forcefully.
- Do not disassemble the product on your own.
- Do not exceed the rated input/output range.
- Use a certified power cord only.
- For the product with an input ground, use a grounded power plug.

CHECKING THE INSTALLATION ENVIRONMENT

This product is a top-notch security device that is equipped with a high-capacity HDD and other key circuit boards.

Note that an excessive internal temperature of the product may cause a system failure or a shortened product life (see the right figure). Keep in mind the following instructions before installing the product.

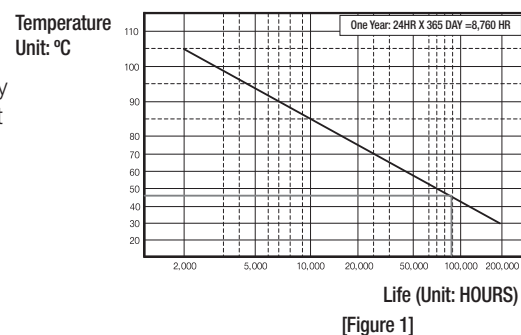

When mounting the product on a rack, comply with the following instructions.

1. Please ensure that the rack inside is not sealed.
2. Please ensure the air is circulated through the inlet/outlet as shown in the picture.
3. If you pile up the products or other rack-mount devices as shown in figure 2, secure room for ventilation or install a vent.
4. For natural air convection, place the inlet at the bottom of the rack and the outlet on top.
5. It is strongly recommended that a fan motor is installed at the inlet and the outlet for air circulation. (Please fit a filter at the inlet to screen dust or foreign substances.)
6. Please maintain the temperature inside the rack or surrounding areas between 0°C ~ 40°C (32°F ~ 104°F) as shown in the figure 1.

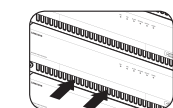
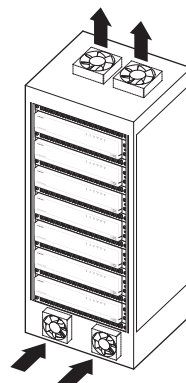

[Figure 2]

Rack Mount Instructions - The following or similar rack-mount instructions are included with the installation instructions :

- A) Elevated Operating Ambient - If installed in a closed or multi-unit rack assembly, the operating ambient temperature of the rack environment may be greater than room ambient. Therefore, consideration should be given to installing the equipment in an environment compatible with the maximum ambient temperature (T_{ma}) specified by the manufacturer.
- B) Reduced Air Flow - Installation of the equipment in a rack should be such that the amount of air flow required for safe operation of the equipment is not compromised.
- C) Mechanical Loading - Mounting of the equipment in the rack should be such that a hazardous condition is not achieved due to uneven mechanical loading.
- D) Circuit Overloading - Consideration should be given to the connection of the equipment to the supply circuit and the effect that overloading of the circuits might have on overcurrent protection and supply wiring. Appropriate consideration of equipment nameplate ratings should be used when addressing this concern.
- E) Reliable Earthing - Reliable earthing of rack-mounted equipment should be maintained. Particular attention should be given to supply connections other than direct connections to the branch circuit (e.g. use of power strips).

RACK INSTALLATION

Install the Bracket-Rack as shown in the figure, and then fasten the screws on both sides.

- Fix the screws not to be loosened by vibrations.

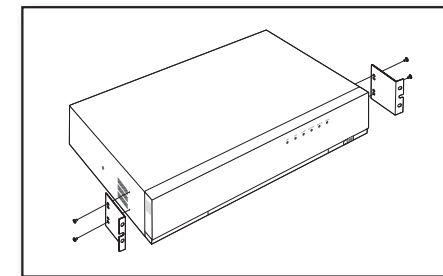

Cautions when Installing in the Rack

To install multiple NVRs in the rack, make sure to separate the FOOT at the bottom of each NVR.

1. There are four FOOTs at the bottom of a NVR. Press the projected parts at both-ends of each "FOOT" and turn it counterclockwise.

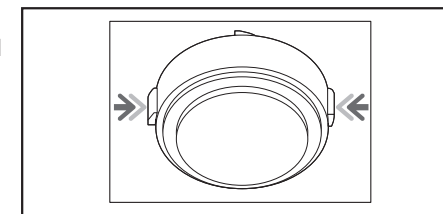

2. "FOOT" is separated from the main body when it is turned to the end of fastening groove.

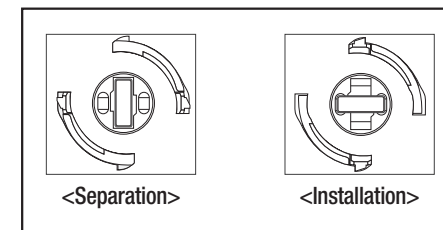

HDD ADDITION

Make sure to unplug the power cord from the wall outlet to prevent possible electric shock, injury or product damage. Please consult your provider for further information on HDD installation since improper installation or settings may damage the product.

- Number of HDDs supported :
XRN-1610: up to 8 HDDs supported, XRN-1610S: up to 4 HDDs supported

- Make sure to unplug the power cord from the wall outlet before proceeding with the installation.

! Cautions for data loss (HDD care)

Please pay attention so that the data inside the HDD is not damaged.
Before adding a HDD, please check the compatibility with this product.
HDD is vulnerable to malfunction due to its sensitive nature especially against shock when operating.
Please ensure that the HDD is free from such shock.
We are not liable for any damage to the HDD incurred by user's carelessness or miss use.

▪ Cases might cause damage to HDD or recorded data

To minimize the risk of data loss from a damaged HDD, please backup data as often as possible.
If exposed to shock when disassembling or installing, data stored in the hard disk may be damaged.
A sudden power failure or turning off the product while in HDD operation may damage the hard disk drive.
HDD or files stored inside may be damaged if the main body is moved or impacted during the HDD operation.

Cautions when installing a HDD

1. Do not apply excessive force to the HDD.
2. Pay attention so as not to lose the disassembly screws or accessories.
 - If the screws or accessories are not put together correctly, the product may breakdown or not operate properly.
3. Please check the HDD compatibility before adding a HDD.
 - Please contact your nearest dealer to obtain the list of compatible devices.

Installing the HDD

- ! ▪ If the installed HDD had been used with other devices, it will be automatically formatted.

How to install an HDD in XRN-1610/XRN-1610S

1. Remove the screws located on the left/right side and on the back side first, then remove the cover.

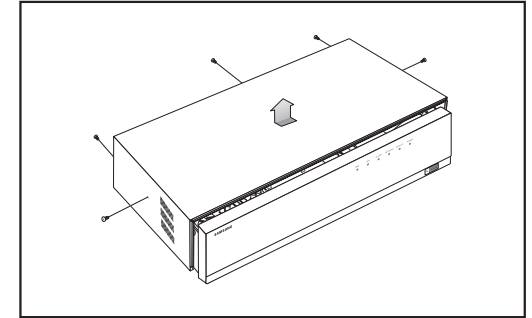

2. Remove the screws on the left/right side (4 screws) and remove the bracket.

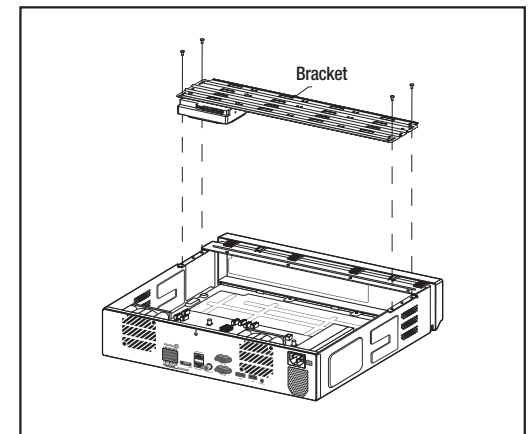

3. Mount HDDs to the bracket and fix with screws.

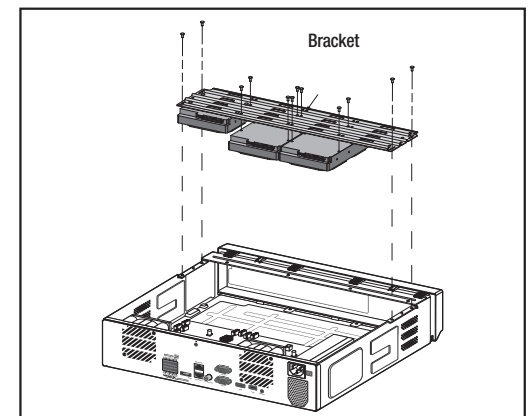

4. Connect the cable to the HDD by matching the HDD SATA/power cable number to the HDD position number on the bracket.
- For the HDD location number on the bracket, please refer to the figure below.

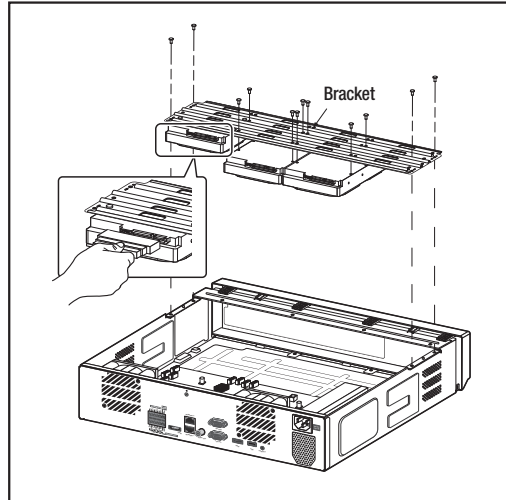

6. Check for any problems in the connection terminal and the wiring in the product, close the cover and fix it with screws.

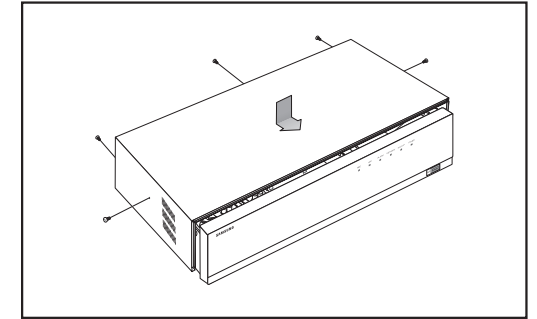

5. Mount the bracket on which an additional HDD is mounted on the NVR, secure it with screws and connect the SATA/power cable to the connector on the main board by matching the number.
- For the connector numbers, please refer to the figure below.

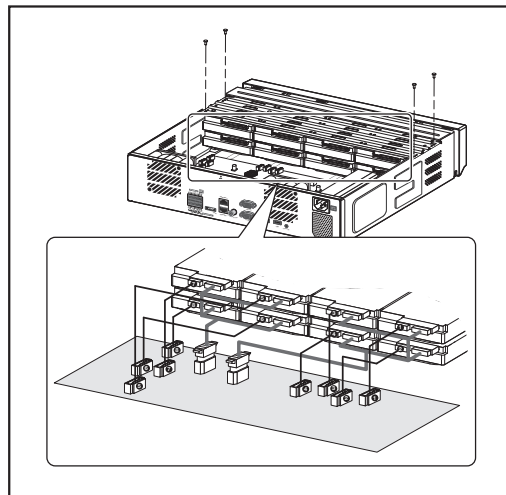

XRN-1610

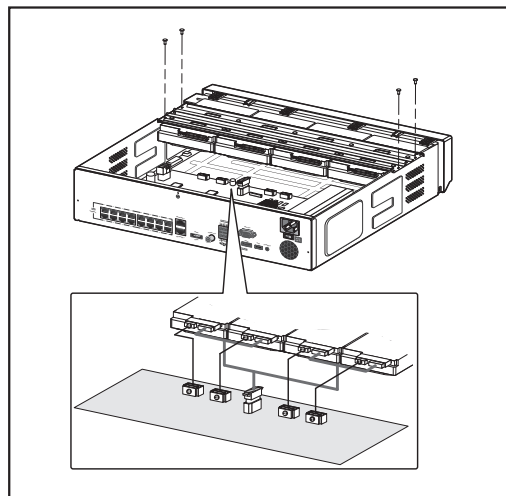

XRN-1610S

connecting with other device

CONNECTING TO AN EXTERNAL DEVICE

 The following figures are based on Model XRN-1610.

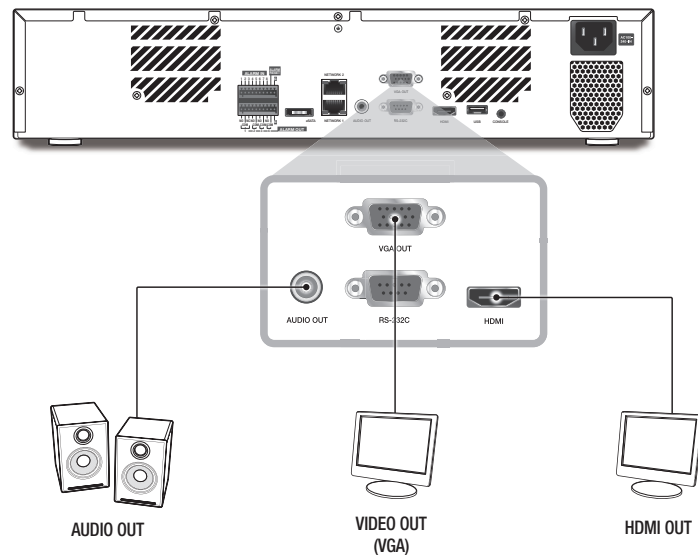

 Unrated or improper power source may cause damage to the system. **Ensure that you use only the rated power source before connecting to the socket.**

CONNECTING THE USB

1. On the front of the product, there is a USB port.
2. You can connect a USB HDD, USB memory or mouse to the USB port.
3. If a USB HDD is connected to the system, recognition and settings are available in "Menu > Device > Storage Device". (Page 37)
4. The product supports hot plugging function that enables connecting/disconnecting USB devices while in operating the system.

-  If you use the USB device for Backup purposes, format it with FAT32 on PC if it is not formatted on the NVR.
- Some USB devices may fail to function properly due to compatibility issue, please check the device before using.
 - Only USB storage devices that comply with the standards (having a metal cover) are guaranteed for data transfer.
 - In case if the USB device's electric contacts have been worn out, data transfer between the devices may not properly function.

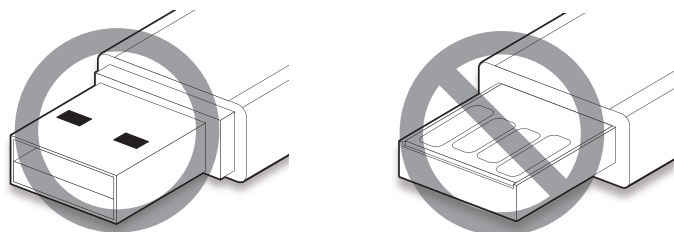

CONNECTING THE ALARM INPUT/OUTPUT

The Alarm In/Out port at the back is composed of the following.

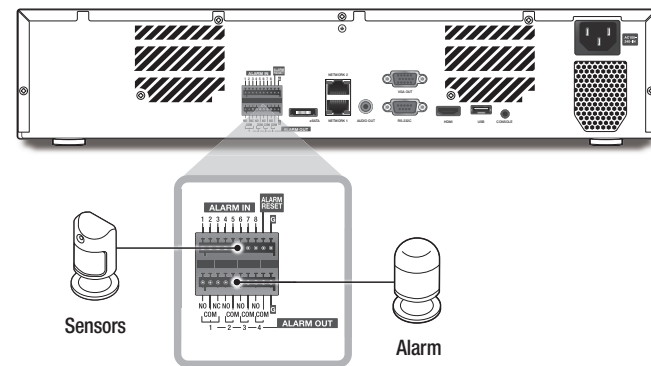

- ALARM IN 1 ~ 8 : Alarm Input Port
- ALARM RESET : On receiving an Alarm Reset signal, the system cancels the current Alarm Input and resumes sensing.
- ALARM OUT 1 ~ 4 : Alarm Output Port

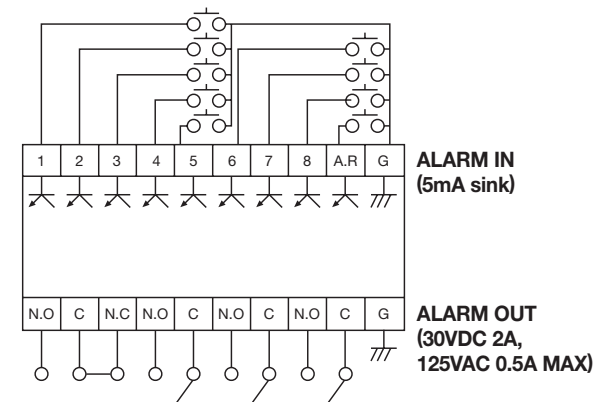

CONNECTING THE NETWORK

For more information about network connection, refer to "Network Configuration". (Page 45)

Network connection via Ethernet (10/100/1000BaseT)

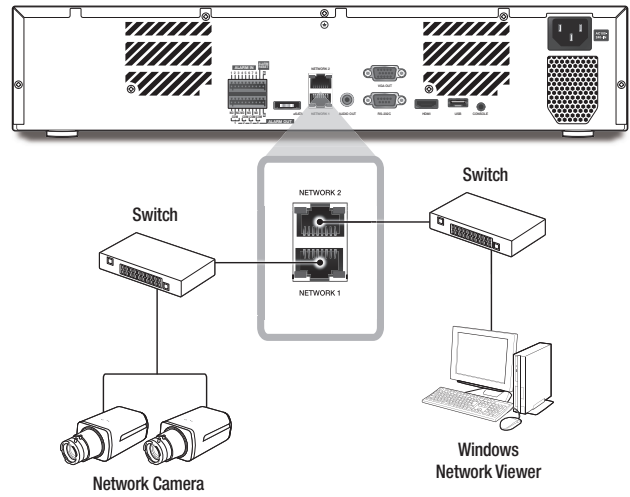

Network connection via router

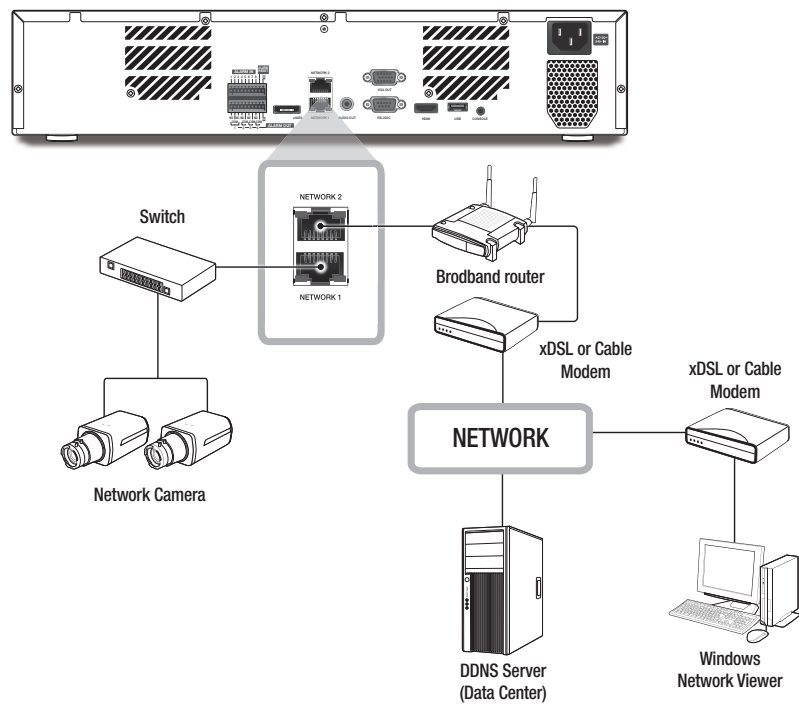

Connecting to Internet through PPPoE

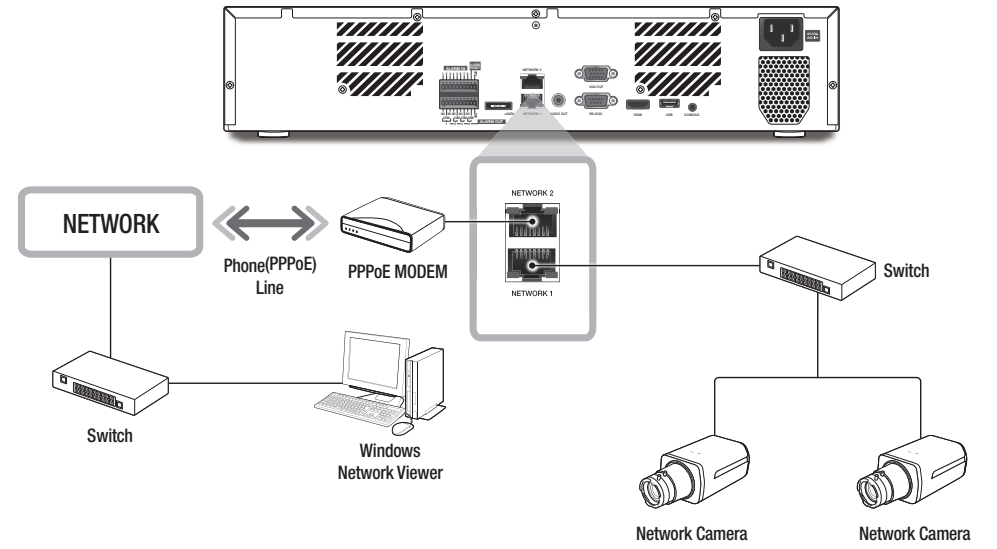

Connecting the network camera

PnP mode(XRN-1610S)

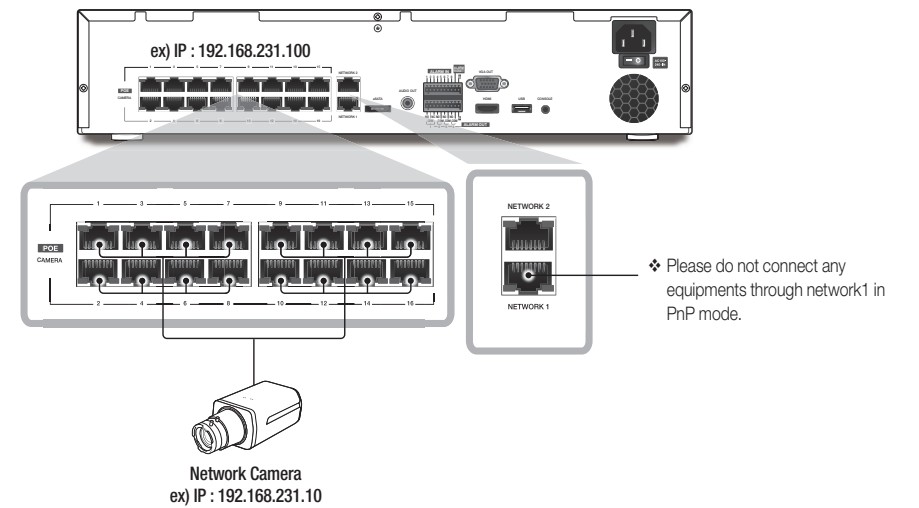

connecting with other device

Manual mode

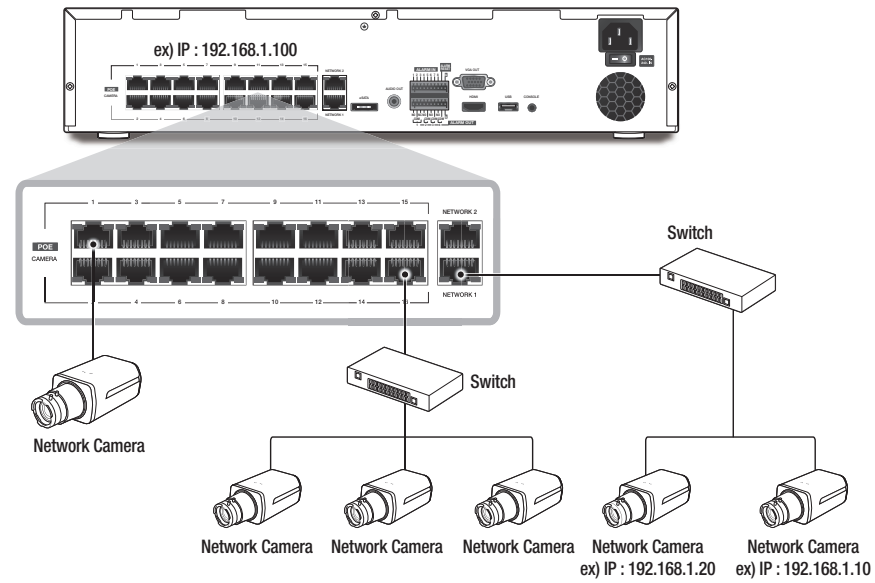

Connecting the iSCSI

Directly connecting to the NVR

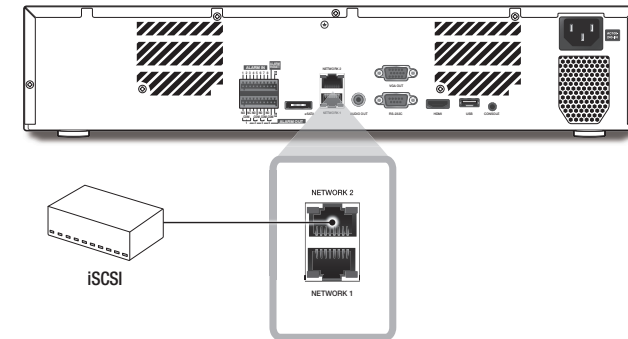

A switch can be used for connection

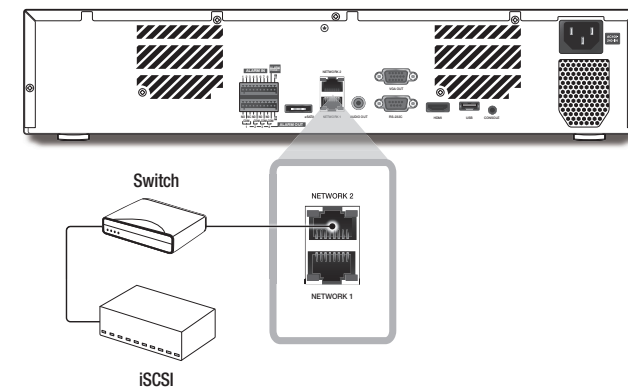

GETTING STARTED

Starting the system

1. Connect the power cable of the NVR to the wall outlet.
2. You will see the initialization screen.
The initialization process will last about 2 minute.
If a new HDD is installed, the initialization process may take longer.
3. The live screen appears with a beep.

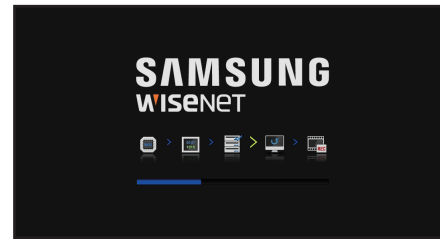

Install Wizard

As shown below, proceed through each step of the <Install Wizard>.

1. In the <Language> screen, select the language and press the <Next> button.
2. In the <ID/PW> screen, set the password and press <Next>.

• Setting Camera Password

You can change the password of the camera en bloc if the camera password is in a factory reset state.

If the camera password is not in a factory reset state, please enter the password of the current camera to register the camera.

- New Password : Input a new password according to the password setting rules.
- Confirm Password : Input the new password again.

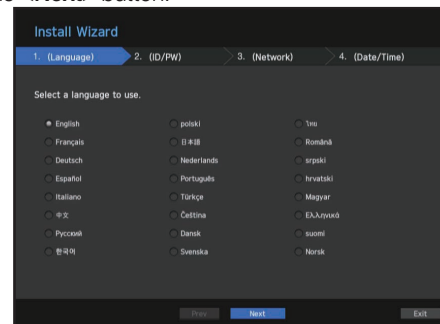

- A camera password registered with ONVIF and RTSP cannot be changed.

• Password setting guide

When you click < ⓘ >, a basic guide for setting a password is displayed. Check the password setting rules.

3. In the <Network> screen, set the network access method and the access environment. To use a simple intranet, click <Next>.
 - DHCP server : If the DHCP server is set to enable, an IP is automatically assigned to the camera. For more information, please refer to "DHCP Server" in the menu settings. (Page 49)
 - Network 1 (Camera) : Connects to the camera and receives the video feed from the camera
 - Network 2 (All) : This is a port for transmitting an image to the webviewer.
 - Network 1 / Network 2 Setup
 - IP Type : Choose the network connection method.
 - IP Address, Subnet Mask, Gateway, DNS

• Switch mode: PnP mode and Manual Setup Mode (XRN-1610S only)

If PnP Mode is selected, NVR will assign IP address to the IP cameras automatically.

If Manual Mode is selected, you need to search and add the IP cameras to the NVR.

- If the LAN cable is not connected to the port, the setting button will not be activated for use. Check the LAN cable connection.
- The built-in DHCP Server in NVR will turn on automatically at stage 3. At this stage, using the existing DHCP server in the same network may cause a problem, as two DHCP servers would be simultaneously operating.
- For more details on network settings, refer to the user manual.

4. After setting the date/time settings in the <Date/Time> screen, click on the <Finish> button to launch the setting completion window.
5. In the setting completion window, click on the <OK> button to finish camera setting and launch the camera registration screen.

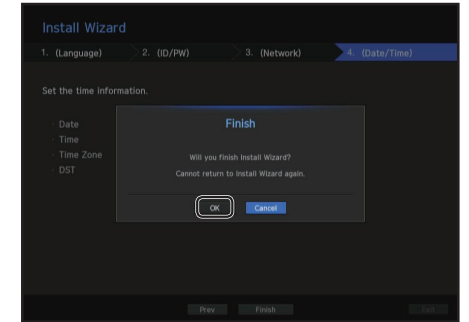

6. If there are 16 or less cameras searched, it will be automatically registered and the camera information(fps, days of recording) will be displayed.

• If there are 16 or less cameras searched

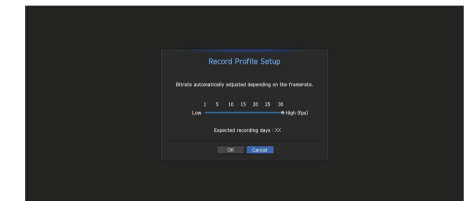
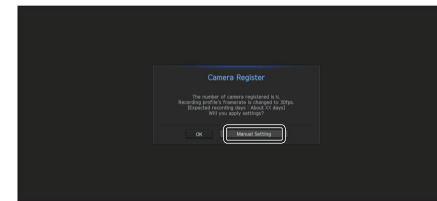

1. The searched camera will be automatically registered and the initial recording value will be displayed.
2. In the camera registration window, click the <Cancel> button to modify the recording settings automatically set.

• If there are more than 16 cameras searched in manual mode

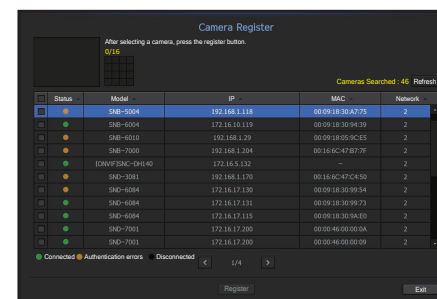

Select a camera to register and click the <Register> button. Once camera registration is finished, proceed in the same steps as after auto registration.

Shutting Down the System

1. In the live screen menu, select <Shutdown>.
2. The "Shutdown" confirmation pop-up window will appear.
3. Click on <OK>.
The system will shut down.

- Only the user with the "shutdown" permission can shut down the system.
- For the permission management, refer to "User > Setting Permissions". (Page 29)

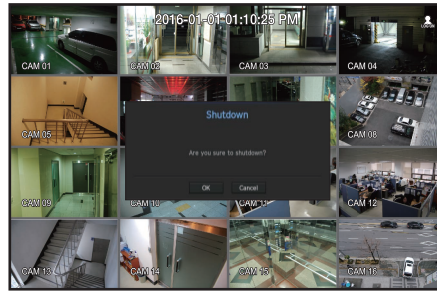

Login

To use the NVR menu, you are required to login as a user that is authorized to access the applicable menu.

1. Right click with your mouse button on the live mode screen.
You will see the context menu on the screen as shown.
2. Select <Login>.
The login dialog appears.

- The initial administrator ID is set to "admin" and you will need to configure the password in the installation wizard.
- Please change your password every three months to safely protect personal information and to prevent the damage of the information theft.
Please, take note that it's a user's responsibility for the security and any other problems caused by mismanaging a password.

- For the restricted permission, refer to "User > Setting Permissions". (Page 29)

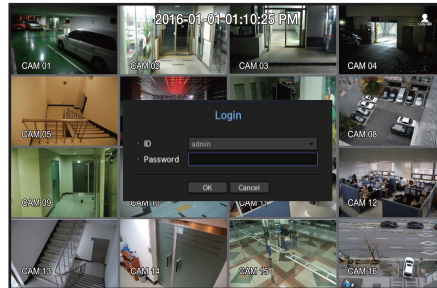

LIVE SCREEN CONFIGURATION

Icons on the Live Screen

You can check the status or operation of the NVR with the icons on the live screen.

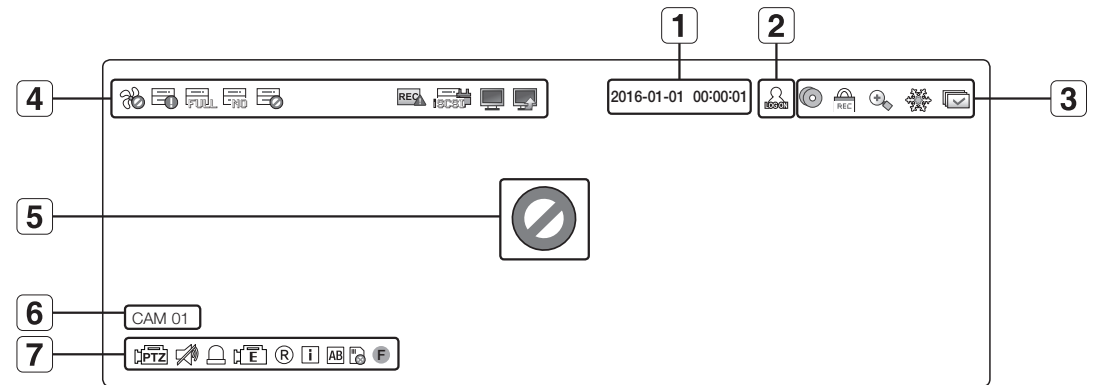

Name		Description
1	Current Date, Time	Displays the current time and date.
2	Login Information	When you are logged in, the "LOG ON" icon will be displayed.
3	Screen Mode	It is displayed when there is ongoing backup in the live condition.
		If access to the recording canceling menu is restricted, then it is only displayed when there is ongoing manual recording. ▪ Only a user with the right to cancel recording can do so.
		It is displayed when the magnifying function is in operation.
		This icon is displayed when you press the Freeze button.
		It is displayed when all the channels are switched at the set time interval.
4	System Operation	It is displayed when there is a problem with the fan.
		It is displayed when the recording data cannot be received properly due to a device problem.
		Displayed if the HDD is full and the NVR has an insufficient space to record.
		Displayed if no HDD is installed or the existing HDD should be replaced.
		Displayed if the HDD needs a technical examination.

Name		Description
4	System Operation	It is displayed when the max permitted amount of data for each channel is exceeded.
		It is displayed when an iSCSI device is disconnected.
		It is displayed when the network is overloaded. <ul style="list-style-type: none"> It occurs when the max receiving allowance is exceeded, causing an overload to the CPU. It will disappear if you modify the camera settings or delete a camera to reduce the performance burden.
		It is displayed when there is firmware to update the server.
5	Video Input Status	Displayed if no input is entered in the condition that the camera is set to <ON>.
		Displayed when the live image with the camera turned <ON> exceeds the supported resolution.
		WISENET Displayed if no permission to live view is granted.
		If a camera is <OFF>, or if no camera is registered, or it is in <Covert2> mode, nothing will be displayed on the screen. If the camera is set to <Covert1>, the video will be displayed but the OSD menus will not be displayed.
6	Camera Title / Channel	Display the camera title and channel number.
7	Camera Operation	This icon is displayed for a channel that a PTZ-featuring camera is connected to.
		Displays AUDIO ON/MUTE. Not displayed in video mode if deactivated.
		If the sensor is set to <ON>, the input signal will be displayed on the screen of the connected channel.
		This icon is displayed when Motion Detection is set to <ON> and a camera motion or camera event occurs.
		It displays the status of general/event/scheduled recording.
		It is displayed when it fails to decode all the frames due to limited decoding performance and in this case only the I-Frame is decoded.
		This is displayed when a POS (text) event occurs.
		RED - Displayed when there is any abnormality in the RED-SD card. YELLOW - Displayed when there is no storage space in the SD card.
		It displayed when Defocus is detected on the camera. Only available on the camera which has defocus detection function.

Error Information

- If the built-in HDD is not connected, the “NO HDD” icon () will be displayed in the top left corner. In this case, make sure you contact the service center for assistance as this may cause a failure of recording, playback or backup.
- If the cooling fan does not work properly or has a problem, the <Fan Information> window will appear and the fan error icon () will be displayed on the top left corner. In this case, check to see if the internal fan works. As a fan error can shorten the product life, make sure you contact the service center for assistance.

If you see the fan error icon or NO HDD, HDD FAIL icons on the screen, contact the service center for more details.

Live Screen Menu

If you right click with your mouse button in live screen mode, it will launch the live screen menu where you can access each menu.

The context menu differs depending on the state of Log in/out, split mode, and NVR operation status.

Depending on the user permissions, you may have limited access to menu items of Live View, Backup, Stop Recording, Search, PTZ, Remote Alarm Output, and Exit.

Single Mode Menu

The single mode menu is available only in Single Mode.

If the menu is displayed as <Screen Mode> in the single screen, it is displayed as a <Full Screen> in the menu where only one channel is selected in the split screen.

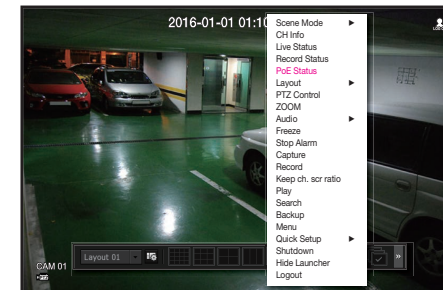

< Single Mode Menu >

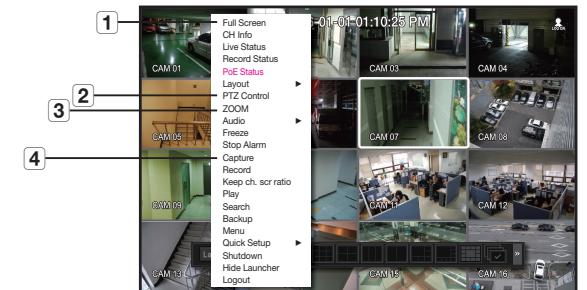

< One channel selection menu in the split screen >

Menu	Description
1 Full Screen	Select and click a desired channel in Split mode to switch to the full screen of the selected channel.
2 PTZ Control	Accesses the PTZ Control menu. The PTZ menu will be active on the Live screen after you select a single channel. (Page 24)
3 ZOOM	You can enlarge the selected screen. (Page 21)
4 Capture	Captures the screen of the selected channel. (Page 23)

Split Mode Menu

In Live split mode, right-click to display this context menu as shown. The context sensitive menu in split mode differs, depending on the login/logout status.

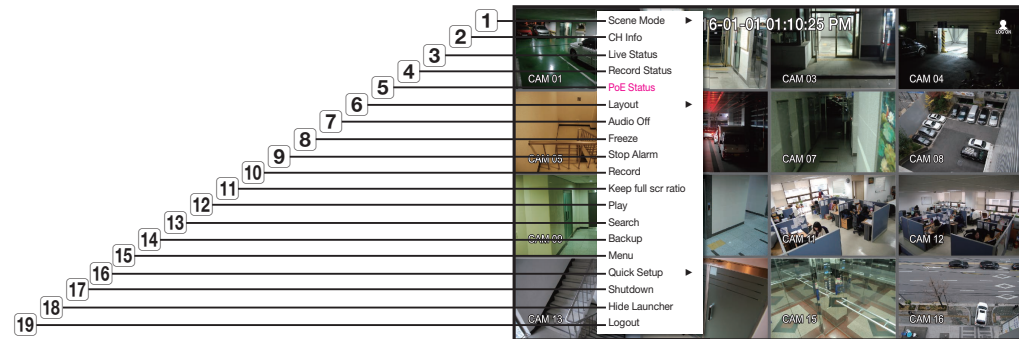

Menu	Description
1	Screen Mode Select a screen mode for the Live screen. Refer to "Live screen mode" . (Page 19)
2	CH Info It displays the camera connection information for each channel. Refer to the "Channel Information" . (Page 20)
3	Live Status Shows the live status of connected camera to each channel. Refer to "Live Status" . (Page 21)
4	Record Status Shows the record status of each channel. Refer to "Record Status" . (Page 21)
5	PoE Status Set the PoE status in each channel. (XRN-1610S only) Refer to the "PoE Status" . (Page 22)
6	Layout Set the layout of each channel. Refer to "Layout" . (Page 22)
7	Audio On/Off Turns ON/MUTE the sound of the selected channel. Refer to "Audio ON/OFF" . (Page 23)
8	Freeze Stop playing the video temporarily. Refer to "Freeze" . (Page 23)
9	Stop Alarm Stop the alarm output, deactivate the event icon and release the auto sequencing. Refer to "Event Monitoring" . (Page 23)
10	Record/Stop Starts/stops the standard recording.

Menu	Description
11	Keep full scr ratio/ Keep ch. scr ratio Channel screen ratio is changed. Refer to "Maintain the Screen Ratio" . (Page 24)
12	Play Refer to "Search & Play > Play" . (Page 52)
13	Search Refer to "Search & Play > Search" . (Page 50)
14	Backup Searches for a backup device and runs backup for each channel or schedule backup later at a more preferable time. (Page 26)
15	Menu Enter the main menu. Refer to the menu settings. (Page 27)
16	Quick Setup The "Camera Register" & "Recording Setup" screen will immediately appear. Quick Setup is unavailable in XRN-1610S PnP mode.
17	Shutdown The system shutdown dialog will appear.
18	Show/Hide Launcher Shows or hides the launcher. Refer to "View the Launcher Menu" . (Page 19)
19	Login/Logout You can log in or out.

View the Launcher Menu

The Launcher menu appears on the bottom of the live screen.

1. Select <Show Launcher> in the context menu of the Live screen.
2. Move the cursor to the bottom and click a desired item in the Launcher menu.

- If no input is entered for 10 seconds, the menu will disappear.
- The Launcher menu can be accessed only by using the mouse.

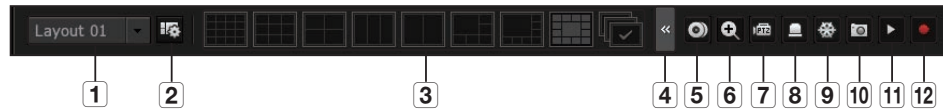

Menu	Description
1 Layout	Select the layout to be displayed on the screen.
2 Layout Setup	You can set, change or delete the new layout of each channel.
3 Screen Mode	Displays a list of split modes available in a bar type. The current screen mode will be displayed grey.
4 Menu Expansion Button	Click to display the hidden menu to the right.
5 Backup	Searches for a backup device and runs backup of each channel or schedule it for later at a more desirable time.
6 Zoom	Enlarges the selected area. This is available only in Single Live mode.
7 PTZ	If the network camera connected to the selected channel supports the PTZ operations, this will run the PTZ control launcher. This is active only in Live single mode.
8 Alarm	Stops the alarm if it's activated.
9 Freeze	Freezes the Live screen temporarily.
10 Capture	Captures the screen of the selected channel.
11 Play	Enters Play mode if a file to play exist, and if not, enters Search mode.
12 Record	Start/End recording the Live screen.

LIVE SCREEN MODE

16 live videos are displayed in a single screen, 8 kinds of split screens, and an automatic switchover screen.

- When you register a camera, the Live4NVR profile is created to set H.264 900*600 30fps as default. If necessary, you can change it in **Menu > Device > Camera > Camera Settings**. If the performance is exceeded, it may play one frame only. If you cannot create an additional profile for the camera specifications, then sometimes you cannot create Live4NVR. In this case, you need to modify the camera profile. Refer to "Camera Setting". (Page 34)

Method for displaying screen mode

If you want to change the split mode, select a screen mode suggested in the launcher menu or right click with the mouse button and select a split mode in the screen mode menu.

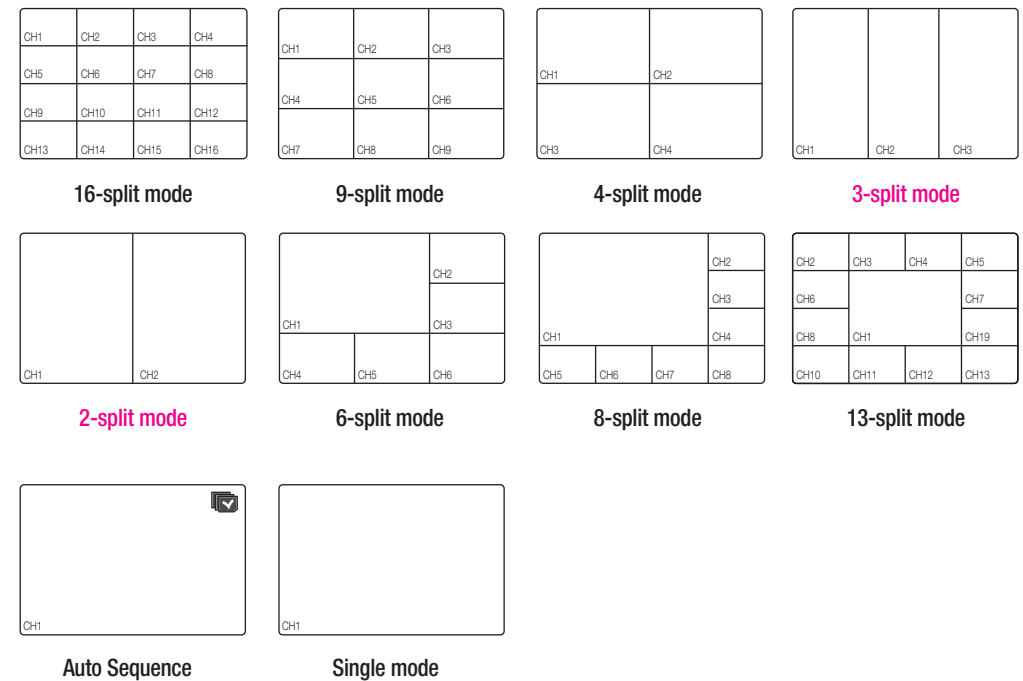

Switching the split mode

You can also play 16 Live channels in the sequence of: Single, 4-split, 9-split and 16-split mode.

Press the button in the launcher or use the right menu to automatically switch the screen.

Mouse right button menu → Screen mode → Auto switching mode

If you reach the end of the steps as outlined in the previous page, you will be moved to the first page and no automatic switching will be performed.

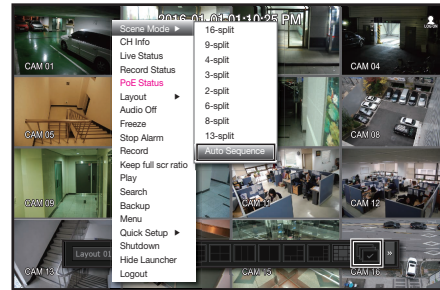

Auto Sequence

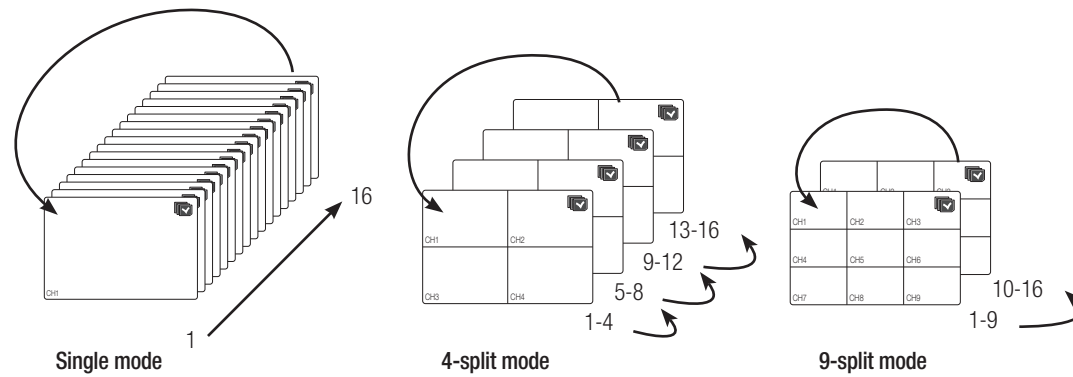

- In a split mode, if you have set <Sequence switching time> in "Setting the Device > Monitor", Auto Sequence will be conducted at the set interval. (Page 40)
- When you switch the channel, the video may be delayed depending on the network condition.

Manual Switching

Click the arrow <◀/▶> key to move to the next split mode.

- If pressing the right [▶] button in 9-split mode :
9-split (CH 1~9) mode → 9-split (CH 10~16) mode → Auto Sequence

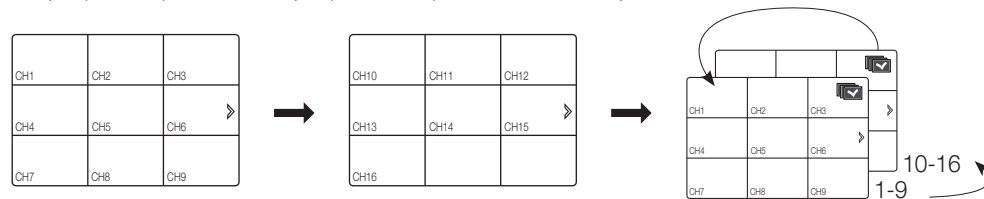

- If pressing the right [▶] button in 4-split mode :
Channel (CH 1~4) → Channel (CH 5~8) → Channel (CH 9~12) → Channel (CH 13~16) → Auto Sequence

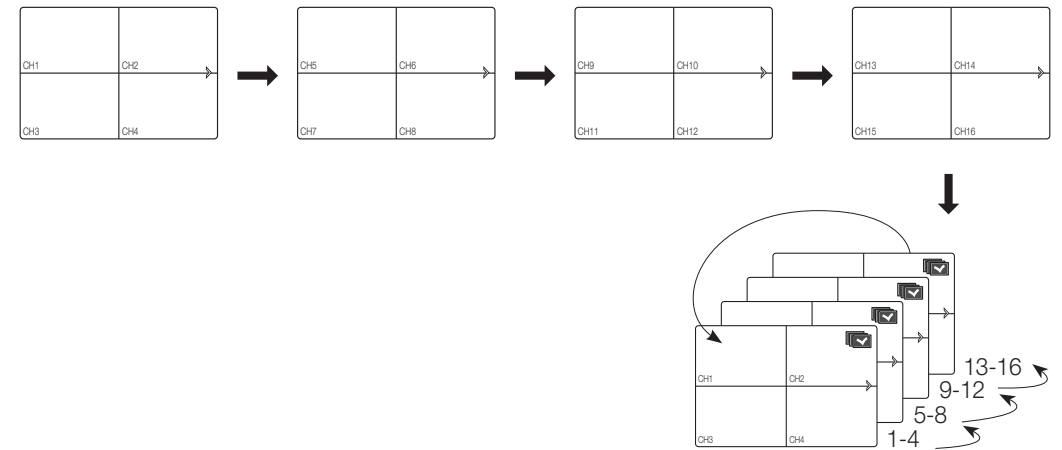

Channel information

Select the <CH info> in the live screen menu to check the status of camera connection to each channel.

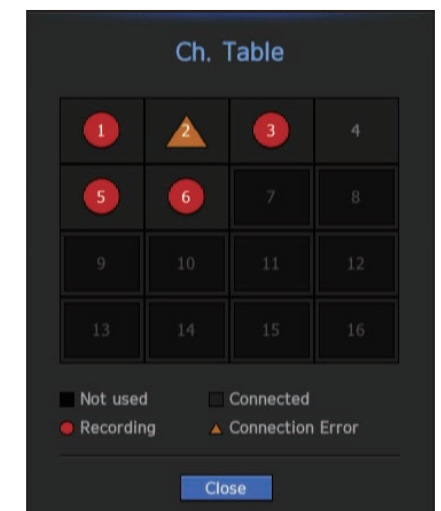

Channel Setting

You can display the channel in a desired area of a split screen.

1. Place the cursor over the camera name of each channel to display the <▼> key to the right on the screen.
2. Click a camera name to display a channel list where you can select a different channel.
3. Select a desired channel and click it.
The current channel will be switched to the selected one.
Use the cursor to select a channel to move, and drag and drop it to a desired channel; this can also change the channel position.
 - Ex : if switching CH 1 to CH 7

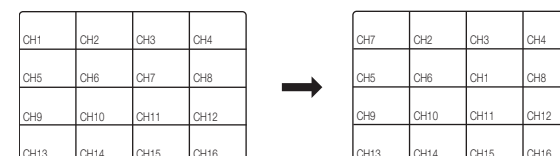

Switching to Single Mode

When in split mode, select and double-click a desired channel to switch to its Single mode.

- Ex : If double-clicking CH 3.

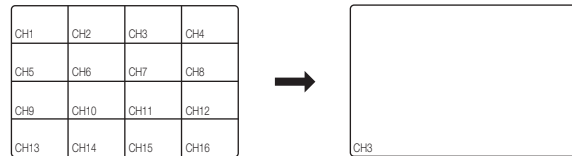

Live Status

Select <Live Status> from the live screen menu to display status and transfer information of connected camera to each channel.

- Model : Displays the camera model name connected to each channel.
- Status : Displays the status of camera connection set to each channel.
- IP Address : Displays the IP address of a camera set to each channel.
- Codec : Displays the live profile codec information for a camera set to each channel.
- Resolution : Displays the live profile resolution of a camera set to each channel.
- Frame Rate : Displays the live profile transmission rate for a camera set to each channel.
- Quality : Displays the live profile transmission quality of a camera set to each channel.

CH	Model	Status	IP Address	Codec	Resolution	Frame Rate	Quality
1	SAMSUNG C...	Disconnected	192.168.0.16	-	-	-	-
2	SAMSUNG C...	Disconnected	192.168.4.128	-	-	-	-
3	SNB-7002	Connected	192.168.0.204	H.264	800X600	20fps	11Best
4	SNB-7002	Connected	192.168.0.204	H.264	800X600	20fps	20
5	-	-	-	-	-	-	-
6	-	-	-	-	-	-	-
7	-	-	-	-	-	-	-
8	-	-	-	-	-	-	-
9	-	-	-	-	-	-	-
10	-	-	-	-	-	-	-

Record Status

Select <Record Status> from the live screen menu to display camera profile, input/recording frame rates, input/limit/recording bps of each channel.

- Total Bitrate (Record/Max) : Record bitrate shows the amount of actual data recording while Total bitrate shows the maximum data transfer allowed by the NVR.
- Profile : Shows the video profile configured to each channel.
- Frame (fps) : Show the input/record frames per second for each channel.
- Bitrate (bps)
 - Limit / Input / Record : Shows the amount of limit/input/recording data for each channel.
 - Input / Limit : Shows the data ratio of actual data transferred from the camera and allowed maximum defined by user.
- Current : Shows the recording status information of currently transferred data.
- MAX : Shows recording information of the most biggest recording data out of configured standard and event recordings.

CH	Profile	Record type	Frame (fps)			Bitrate (bps)			
			Input	Record	Limit	Input	Record	Input/Limit	
1								0.0%	
2								0.0%	
3	H.264	Normal	FULL	1.8	1.8	25.0M	0.3M	0.3M	1.2%
4	Rec-NVR	Normal	FULL	3.9	3.9	25.0M	0.3M	0.3M	1.2%
5								0.0%	
6								0.0%	
7								0.0%	
8								0.0%	

Total Bitrate (Record/Max) : 0.6/256.0Mbps
 HDD Size (Free/Total): 5971 / 5983 GB
 Recording (Free/Total): 826 days 8 hours / 828 days 0 hours
 Overwrite : OFF
 Record Setup

- : Reloads the recording information.
- Record Setup : The menu screen will switch to the record setting screen.

- The warning message on the list's bottom means the NVR replaced the selected recording profile with other available profile, since the selected one does not produce video data which prohibits screen saving. If the screen displays video, it automatically resets to the selected profile and its name turns to yellow in the list.
- If Key Frame recording exceeds the allowed data amount specified by limit bitrate, a popup alert and icon appear on the screen. The limited recording alert popup does not repeat after displaying once unless camera or recording settings are changed; it may appear again if settings were changed to notify such status. If you want to set the alert popup not to appear, change your setting of <Setup Warnings> not to display a message popup. For further information on bitrate limit of recording data, refer to "Record Setting". (Page 41)

ZOOM

This is activated only in Live Single mode.

After selecting a single screen, if you use the Magnify function, the selected area will be magnified by 3.

- In the live screen menu, select <ZOOM>. You can also click on <🔍> in the launcher menu. The Magnify icon in the middle of the screen will be displayed.
- Drag and drop with your mouse to select the area to magnify.
- Double click on it to magnify the selected area by 3.
 - In the magnified screen, you can drag and drop the selected area for magnification.
- In the live screen menu, select <Zoom Out>. Click on <🔍> in the launcher menu to release the magnification function.

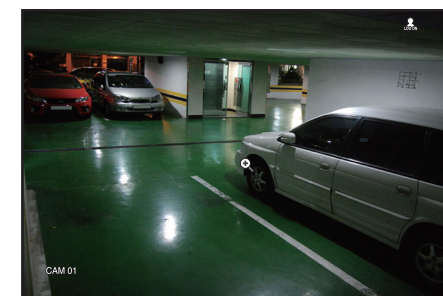

<Normal>



<Enlarged 3x>

POE STATUS(XRN-1610S)

In the live screen, you can see the PoE status of each port.

1. Select the <PoE Status>.

PoE status view window is displayed.

- Consumption(W) : Displays the power consumption in PoE.
 - 0 : No device is connected to the port or a device is using its own power supply.
 - - : Trouble in the port (More detailed trouble information can be displayed in additional information.)

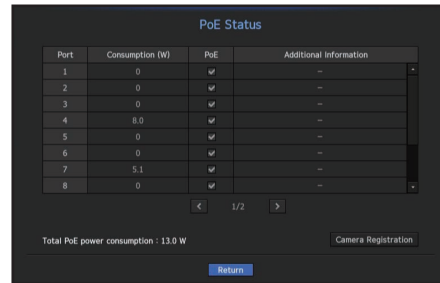

Overall PoE power specifications for XRN-1610S(16 ports) is 220W, if a single port exceeds 36W, or the power to all ports exceeds the overall PoE power specifications, the power to ports will be shut off sequentially.

- PoE : Turns on/off the power supply to the camera. If checked, it means the power supply is On; if not checked, it means it is Off.
- Additional information : If there is a problem in the power supply, it is explained here. Power supply problems include excessive power (class 1 to 4) and voltage errors.
- Total PoE power consumption : Display the sum of power consumption for all the ports.

2. Press <Return> to move to the previous screen.

Noise level according to PoE power consumption

Model	Noise Level [dB]	PoE Power
XRN-1610S	50	196W
	48	154W
	47	138W

LAYOUT

In the live screen, you can set the layout for each channel.

Setting Up the Live Layout

This section outlines how to select a series of channels based on their purpose/accessibility and monitor them in a single layout.

Example) Layout "Lobby" - Lobby camera 1, Lobby camera 2, Front entrance camera 2

Layout "VIP" - Directors' meeting room 1, Directors' meeting room 2, Directors' lounge 1, Corridor camera on the 7th floor

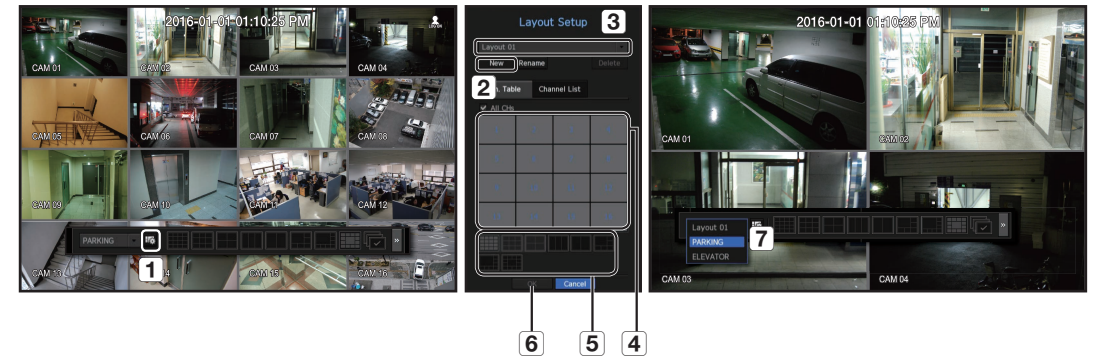

To create a new layout, follow these steps:

- 1 Open the channel layout setup menu.
- 2 Click <New>.
- 3 Enter a name for the selected channels (e.g., ELEVATOR).
- 4 Select the channels that you want to add to the layout (e.g., 2, 7, 10, 15).
- 5 Choose a split mode to apply (e.g., 4-way split).
- 6 Click <OK>.
- 7 Choose a layout to view it on the screen (e.g., change to ELEVATOR).

1. Select the <New>.

The layout setting screen will appear.

- New : You can set the new layout.
- Rename : Rename Layout. You can make changes to the selected layout. When the layout is changed, the channel order is initialized.
- Delete : You can delete the selected layout.
- Channel Table : You can select channels in the table to be registered in, or removed from the layout.
- Channel List : You can select channels in the list to be registered in, or removed from the layout.

2. Press the <New> button and enter the name of layout to add.

3. In the <Ch. Table> or <Channel List>, click and select the channel to be displayed on the layout screen.

4. Click on <OK> to save the selected layout.

The layout for each user is saved separately.

AUDIO ON/OFF

You can turn the sound on/off corresponding to the channel in Live mode.

AUDIO ON/OFF in Single mode

Click on the audio icon (🔊) on the screen to turn it ON/OFF.

- ✎ If you have configured the audio output settings properly but the audio or voice is not output, check if the connected network camera supports the sound signal and if you have configured the sound settings as appropriate. The sound icon can be displayed if the sound signal fails to output from noise.
- Only the channel where <AUDIO> is set to <ON> in "Setting the Device > Camera" displays the audio icon (🔊) in Live mode that you can use to turn the sound on/off.

FREEZE

This is available only in Live mode, this pauses playing the Live image temporarily.

1. Click <⚙️> of the launcher mode. Video playing is paused.
2. Click on <⚙️>. Pause is canceled. Playing is resumed.

EVENT MONITORING

This will display the channel in sync with a specific event (Sensor/Motion/Video Loss) if it occurs. In "Monitor > Event Display", set the event monitoring to ON/OFF and specify the event display time. (Page 40)

- If multiple events occur simultaneously, the screen will switch to a split mode.
 - 2~4 events : 4-split mode
 - 5~9 events : 9-split mode
 - 10~16 events : 16-split mode
- If the second event occurs within the set time of <Event Display>, the first event will last until the second one is terminated.
 - Ex : If you set <Event Display> to 5 seconds, and only one event occurs in CH 1.

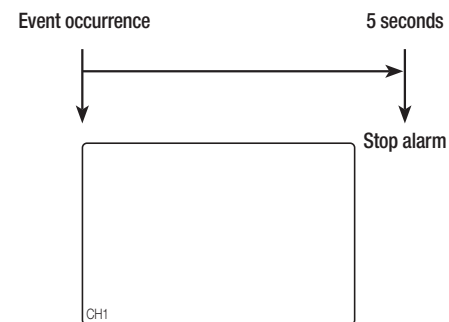

- Ex : If you set <Event Display> to 5 seconds, and the second event occurs in CH 2 within the set time after the first event occurred in CH 1.

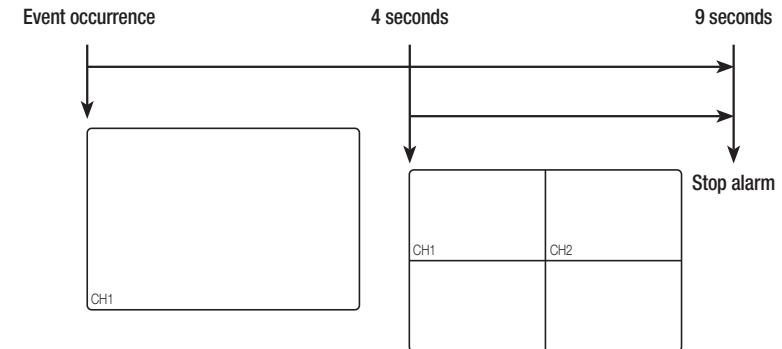

- ✎ Select <Stop Alarm> to initialize the status of alarm output and release the event function.
- If an alarm is output with the pre-event and post-event times specified together with the event recording settings, the event recording will perform according to the specified recording type (pre event or post event).
- ! In case of continuous events such as motion detection, switching to another split mode display may not immediate if concatenating events follow, even when you stopped alarm of the event.
 - The video may be delayed depending on the network condition.
 - The event output can be delayed as the transfer of the alarm event from the network camera takes time.

CAPTURE

You can capture a screen selected on the live screen. Function to perform in single channel mode on the live screen or when selecting a channel.

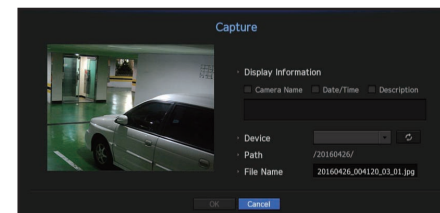

1. Select <Capture> from the live screen menu. You can click on <📷> in the launcher menu.
2. Select the output information to be displayed on the captured screen.
 - When you select the <Description> check box, a window to enter a description is opened and you can enter up to 50 Korean letters.
3. Select a device to save a captured file, file path and file name.
4. Complete the settings and click <OK>, then the image captured from the screen is saved to the selected device.

MAINTAIN THE SCREEN RATIO

The screen ratio for a live video can be changed.

Maintain a screen ratio for all channels

Video screen ratio for all channels can be changed in live split screen mode.

1. Select **<Keep full scr ratio>** from the live screen menu.
The screen ratio for all channels will be changed.
2. If you want to go back to the previous screen ratio, check the menu option for **<Keep full scr ratio>**.

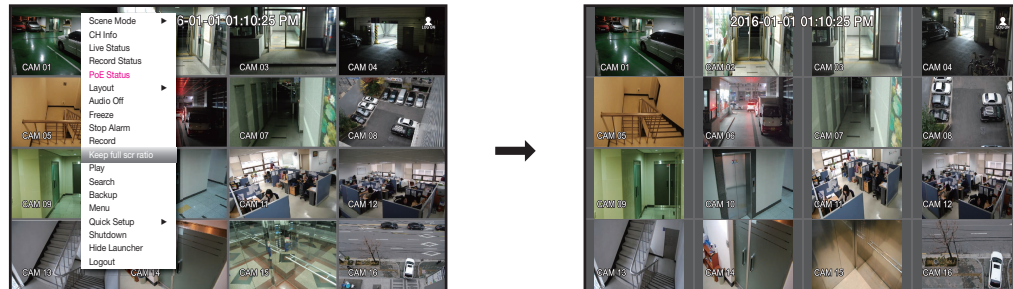

Maintain a channel screen ratio

If you select a channel from a live single screen or split screen, you can change its video screen ratio.

1. Select **<Keep ch. scr ratio>** from the live screen menu.
The screen ratio of a specified channel will be changed.
2. If you want to go back to a previous screen ratio, select **<Keep ch. scr ratio>** again.

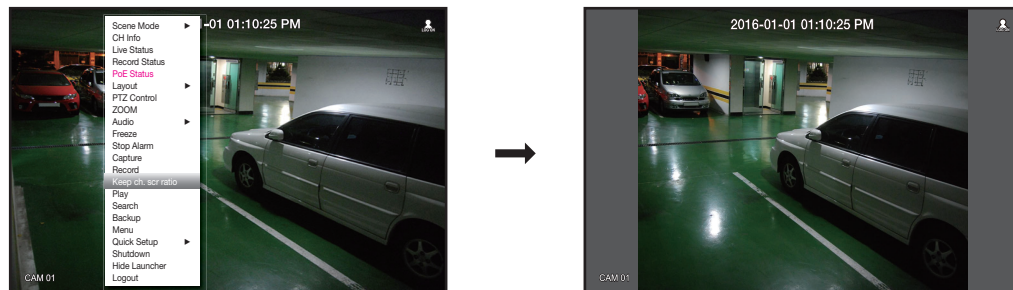

DISPLAY TEXT

Change text output

The NVR can display text on a live screen when a text device is set.

Select text output

This is executable when a text device is connected.

- How to turn the text output off : Select **"OFF"** from the text list.
- How to display on other devices differently from the preset device : Select a device to display from the text list.

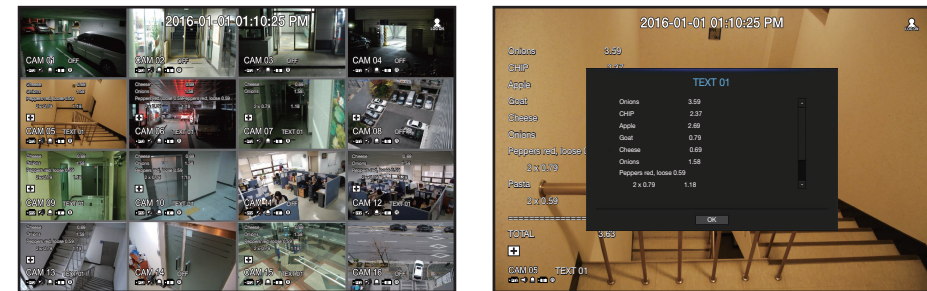

PTZ CONTROL

With this NVR, you can configure the settings of a PTZ camera as well as commercial cameras in the market to your preference.

PTZ device

This is active only if a channel that a PTZ camera is connected to is selected.

Getting started with PTZ operations

The PTZ camera will be activated only if the channel of the PTZ camera is selected, which can be performed in the following way:

- Using the launcher menu : Click **<PTZ>** from the launcher menu of the Live screen.
- Using the Live screen menu : Select **<PTZ Control>** in the context menu of the Live screen.
- Using the icons on the Live screen : Simply click the **<PTZ>** icon on the Live screen.



- This is available only if a PTZ camera is connected and the **<PTZ>** icon is displayed on the screen.
- Even if the connected network camera does not support the PTZ operations, you can configure the PTZ control settings (if possible) by installing the PTZ driver (physical device).
- It only supports a network camera with Hanwha Techwin's PTZ function and a camera registered in the ONVIF.

Using the PTZ camera

You can use a single PTZ camera to perform the Pan, Tilt and Zoom operations to monitor multiple places, and configure the custom settings of the presets in a desired mode.



1. Open the <PTZ Control> menu.

The <PTZ> icon in the left bottom of the screen will turn yellow, indicating that the system accesses "PTZ Control" mode. You will see the "PTZ Control" launcher menu.

- The PTZ working (active) mark can be active even if the PTZ operation is not available in normal mode. So ensure that you have completed the PTZ settings before proceeding.

2. Use the PTZ Wheel in the launch menu to adjust the location of recording by a camera.

- Sensitivity : Adjust sensitivity for Pan, Tilt controls.
- PTZ Wheel : Click a near area from the center to move the camera lens slowly; clicking a far area will move it fast.
 - If clicking and holding the mouse in the left will turn the camera counterclockwise; if clicking and holding the mouse in the right will move the camera lens clockwise.
- Zoom : Activate the Zoom operation of the PTZ camera.
- Iris : Adjust the amount of light incoming to the camera.
- Focus : You can adjust the focus manually.
- Swing : Swing is a monitoring function that moves between two preset points and enables you to trace the motion.
- Group : The group function enables you to group various presets before calling them in sequence.
- Trace : Tracking remembers the trace of movements that you instructed and reproduces it for your reference.
- Tour : Monitor all the groups created by a user in turn.
 - Some cameras may differ in the menu title and operation with regard to Swing, Group, Tour and Trace.

- ! ▪ Even if the network camera supports the PTZ operations by default, the PTZ control can be enabled only if the applicable menu is active in the launcher menu.

Using Digital PTZ (D-PTZ) function

1. Register a camera that supports the D-PTZ profile.
 - In cameras that support the D-PTZ profile, you can use the D-PTZ function.
2. Both cameras that support general PTZ and cameras that support D-PTZ can control the live image using some of the <PTZ control> function menus.
 - For more information about the supported functions, please refer to the camera manual.

Preset

Preset is a specific position remembered by the PTZ camera. You can use the Preset function to define up to 255 presets for a single PTZ camera.



To add a preset

1. Check the preset checkbox.
2. Select <[Keyboard]>.
 - The virtual keyboard will appear on the screen. Use it to provide the preset name.
 - Refer to "Using Virtual Keyboard". (Page 28)
 - [Icon] : You can change NVR preset settings to your preference.
 - [Icon] : Delete a selected preset.
 - [Icon] : Delete all the existing preset settings.
- ! ▪ You can add up to 255 presets, which is the max count supported by the NVR.
 - If you replace a camera that saves your preset settings with a different one, you must configure the preset settings again.
3. Select <OK>.
 - The preset setting will be saved in the provided name.

To change or delete a registered preset

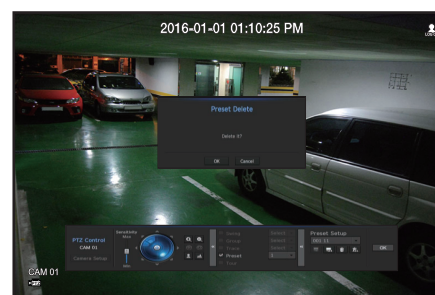

1. Check the preset checkbox and select a preset to change or delete.
2. Press <[Icon]> or <[Icon]> as needed.
 - [Icon] : Delete all the existing preset settings.
- ! ▪ If you delete the entire presets, the default presets specified in the network camera can be deleted accordingly.
3. Provide a new name and press <OK>.

BACKUP

You can check the backup device and set the backup schedule by channel or by time.

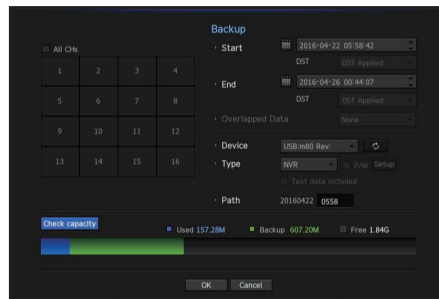

1. Select <Backup> from the live screen menu.
You can click on <👁> in the launcher menu.
 2. The backup settings screen will be opened.
 - Channel : Sets the channel to backup.
 - You can select multiple channels.
 - If you select <All CHs>, all channels will be selected.
 - Backup Range : Sets the <Start> and <End> time for the backup.
 - Overlapped Data : Shows a list of overlapping data on a same time according to the number of data. It appears when one channel has multiple data on a certain time point due to changing of time or time zone settings, etc.
 - Refer to time and time zone of "Setting the Date/Time/Language". (Page 27)
 - Device : Select a backup device from the recognized devices.
 - Type : Sets the backup data format.
 - NVR : Saved data can be played back only by the NVR.
 - SEC : Saves data in the proprietary format with built-in viewer, which supports immediate playback on a PC.
 - When you select the SEC format, you can select or deselect "Password" and "Text data included".
 - Path : displays the location of the folder in which the backup file is to be saved.
 - Check capacity : Shows the size of the selected backup data, used and available capacity of the selected backup device.
 3. When the backup setup is done, press <OK>.
 - If no available device is recognized for backup, <OK> button is not activated.
- ! ▪ The application may slow down during the backup.
- You can switch to the menu screen during the backup in operation, but playback of data is not available.
- The data can be played back on a Webviewer while the backup is in progress but audio does not function.
- If backup has failed, select "Device > Storage Device" and check the free space of the HDD and check also if the HDD is properly connected.
- ✍ ▪ Pressing the <Exit> during the backup will return to the previous menu, while the backup progresses.

menu setup

You can setup the system, devices, and options for recording, event and network.

SYSTEM SETUP

You can setup Date/Time/Language, User, System Properties and Log.

Date/Time/Language

Setting the Date/Time/Language

You can check and setup the current Date/Time and time related properties, as well as the language used for the interface on the screen.

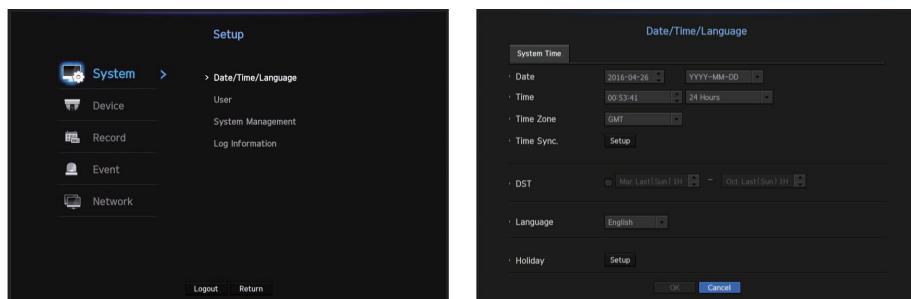

- Date : Sets the date and its format that will appear on the screen.
- Time : Sets the time and its format that will appear on the screen.
- Time Zone : Sets the time zone of your area based on the Greenwich Mean Time (GMT).
 - GMT (Greenwich Mean Time) is standard World Time and the basis of world time zone.
- Time Sync. : Specify the use of synchronization with the time server.
Click the <Setup> button to display time synchronization setup screen.
If you select to use the <Time Server>, the current time will be synchronized on a regular basis by the server defined as <Time Server>.
If this is the case, you cannot change the time setting manually.
 - Synchronization : Specify the use of synchronization with the time server.
 - Time Server : Enter an IP or URL address of the time server.
 - Last Sync Time : Displays the most recent synchronization time from the selected time server.
 - Activate as Server : Set to <Use> to allow the NVR to act as a Time Server for other NVRs.
- DST : Set up Daylight Saving Time with its period to make the time earlier than the GMT of its time zone by 1 hour during the set period.
- Language : Select your language. Sets the language for the interface.
English, French, German, Spanish, Italian, Chinese, Russian, Korean, Polish, Japanese, Dutch, Portuguese, Turkish, Czech, Danish, Swedish, Thai, Romanian, Serbian, Croatian, Hungarian, Greek, Finnish, and Norwegian are supported.

- Holiday : A user can select specific dates as holidays according to their own preferences. Holidays are applied in the <Recording Schedule> or <Alarm Schedule> setting too.

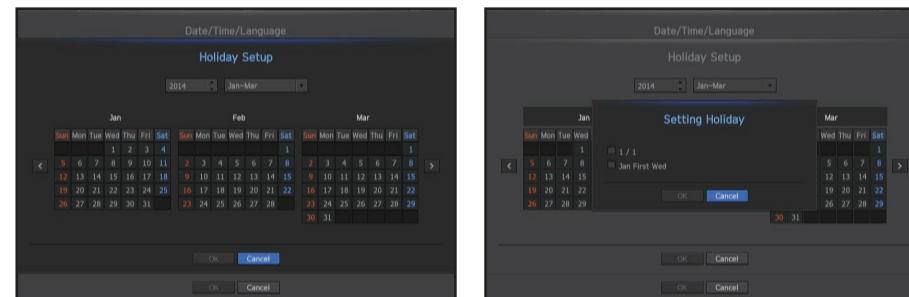

- e.g. every first day of a year is set to be a holiday if you select January 1 and check <1/1>, and every first day of a year and every first Wednesday of January are set to be holidays if you check <1/1> and <Jan First Wed>.

To use the calendar

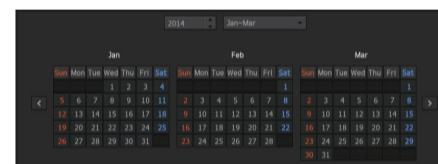

1. Select year and month.
Select the < < > > key on both ends of year and month to move back/forward to the previous/next year or previous/next three month.
2. Select a date and click on the <OK> button.
 - A date is marked in gray if there exist data for search for system log, event log, time search and event search.

User

You can set permissions of each user over the NVR's specific function and settings.

Setting the Administrator

You can set and change Administrator's ID and password.
The administrator can use and set all menu items and functions.

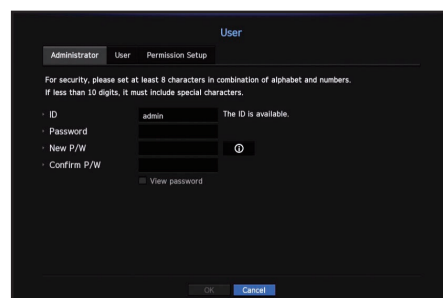

- ID : Change the admin ID.
 - Password : Checks the current password.
 - New P/W : Enter new password.
 - Confirm P/W : Confirms the new password.
 - If <View password> is selected, the password will no longer be hidden on the screen when you type it.
-  The initial administrator ID is set to "admin" and you will need to configure the password in the installation wizard.
- Please change your password every three months to safely protect personal information and to prevent the damage of the information theft. Please, take note that it's a user's responsibility for the security and any other problems caused by mismanaging a password.
 - If you click <ⓘ>, a basic guide for password setup is displayed.

Using Virtual Keyboard

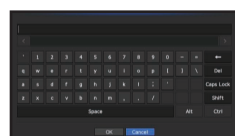

1. For alphanumeric inputs, the virtual keyboard window appears.
2. Using a mouse, click on the desired character tab.
3. In the upper text input box of the virtual keyboard, there displays a list of candidate words containing the selected character.
4. Select a word from the list, or use the keyboard to enter the whole word.
 - If there are many of candidate words, use <←> buttons to move between them forward and backward.
5. Select <OK>. Entered word is applied.
 - For upper case letters, use <Caps Lock> button.
 - For special characters, use <Shift> button.
 - Using the virtual keyboard is the same to a normal keyboard use in your region.
 - ID allows alphanumeric characters only.
 - The password should at a minimum be an 8-digit combination of alphabetical letters and numbers.

User setting

You can create a group or set permissions for each group.
You can add a user and edit the registered user information.

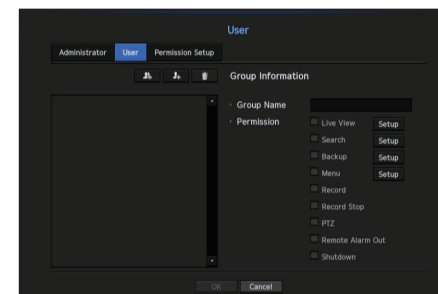

If you want to add a group

1. Click on the [] button to launch the Group Addition popup window. If you want to add a group, click on <OK>.
2. Press the group name item to launch the virtual keyboard used to enter group names. Enter the group name to register.
 - You can add a maximum of 10 groups.

If you want to set group permission

Set permission to access each group.
Each group's users can only access items with a check mark beside them.

1. Select the menu to set group permissions. The menu with access permissions will appear when a user of the group logs in.
 - Live View : You can set permissions to access the live screen for each channel.
 - Search : You can set permissions to access the search menu for each channel.
 - Backup : You can set permissions to access the backup menu for each channel.
 - Menu : You can select and set the setting menu that can be accessed. A group user can only access the menu selected. If you select the menu, the menu permission setting screen will be displayed.
 - Record Stop, PTZ, Remote Alarm Out, Shutdown : You can select these functions to add to a group's permissions.
2. Click <OK>. Check a group user to give them the permission to access the selected item.

If you want to register a user

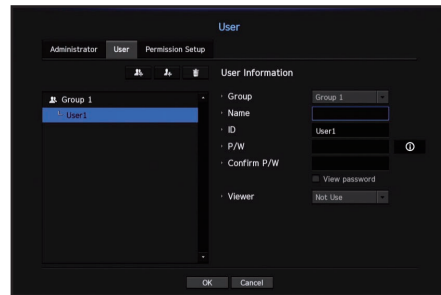

1. Click on the [] button to launch the user addition popup window. To add a user, click on <OK>.
2. Select a group.
When registering a user, the selected group will be automatically registered.
 - A group can be changed after inputting all required information.
3. Enter name, ID, password and select whether to use the viewer.
If you activate use of <Viewer>, you will have the right to use the web viewer and the network viewer.
4. Click <OK>.
Registered user information will be saved.

When you want to delete the group and user information

1. To delete, click on the [] button.
2. The deletion confirmation window will appear and you can select an item to delete and click on <Delete>.

Setting Permissions

You can set restricted access for all general users. Items with restrictions will require logging in for use.

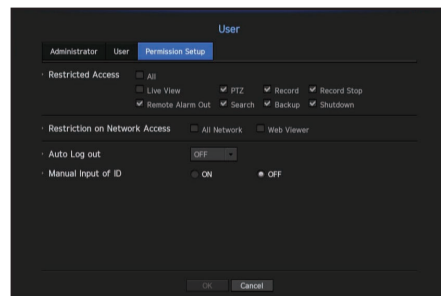

- Restricted Access : All menu items allowed for a user can be set with restricted access.
 - Checked () : Restricted
 - Not checked () : Accessible
 - If it is not checked () in <Restricted Access>, any user can access the item no matter what the <Permission> setting.
 - If it is checked () in <Restricted Access>, a user can access the item only if the user has permission in <Permission> setting.

- Restriction on Network Access : Restricts remote access from a <Restricted Access> network.
 - All Network : Restricts all access instances via Network Viewer and Web Viewer.
 - Web Viewer : Restricts access via the Web Viewer.
- Auto Log out : A user will be automatically logged out if there is no operation on NVR for over set period of time.
- Manual Input of ID : In the login window, select whether to enter ID.

If the user has restricted access

If a new group is restricted to access the entire menus, the users belonging to the group can access only the basic menus and can change only their respective password.

If all permissions are restricted, you will see only some menu items accessible in the Live screen menu.

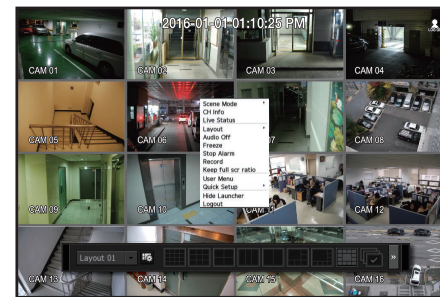

To change the user password

If you log in with the user account of a group with restricted access, you just can change your own password.

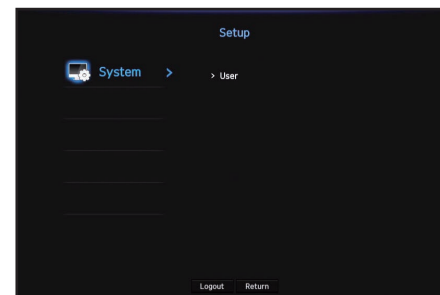

1. Provide the login information.
2. Select <User Menu>.
The Permission Management screen appears.
3. Select <User>.
The Password dialog shall appear.
4. Provide a new password.
5. Select <OK>.
The old password will be changed to a new one.

System Management

You can check the system version, update to a newer version, as well as data backup and initialization.

Checking the System Information

You can check the current software version and MAC address before proceeding with the upgrade.

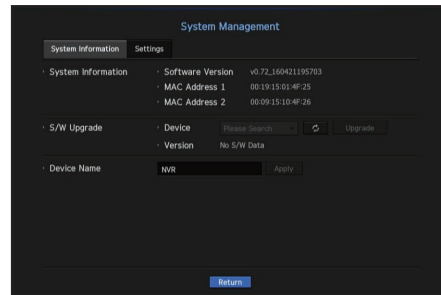

- System Information : Shows the current system's information. The values can not be changed by a user.
- S/W Upgrade : Updates the NVR's software up to date.
 - Press the <  > button to search for and display the equipment to upgrade.
- Device Name : Displayed if the network viewer is connected to NVR.

To upgrade the current software version

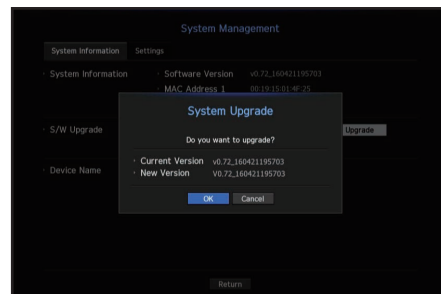



1. Connect a device storing the software to be updated.
 - It may take about 10 seconds to recognize the device.
 - Upgradeable devices include USB memory, and network device.
 - To update the network, the current NVR should have been connected to the network. Upgrade via the proxy server may not be enabled due to the restricted access.
2. Select <System Management> from <System> window.
3. Select <System Information>.

4. When the recognized device appears, select <Upgrade>.
 - If you connect a device in the upgrade menu window, you can press the <  > button to search for available software.
 - If there is an upgrade image on the network, the popup window will appear.
 - The <Upgrade> button will be activated only if the current <Software Version> of the <System Information> is same to or older than that of <S/W Upgrade>.
5. Press <OK> in the "S/W Upgrade" window.
 - While updating, it shows the progress.
6. When the updating is done, it automatically restarts. Do not turn the power off until it finishes restarting.
 - If "Upgrade Failed" appears, retry from the step 4. When you experience continued failure, consult the service center for assistance.

Settings

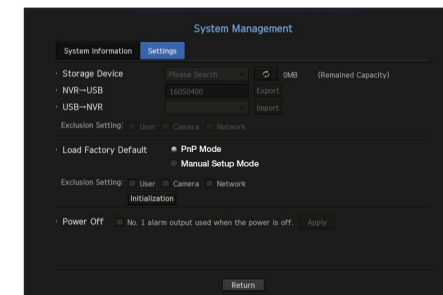
You can export and import the NVR settings by using a storage media.



- Storage Device : Shows the connected storage device.
 - Press the <  > button to view the list of storage devices.
- Export : Exports NVR settings to the connected storage device.
- Import : Imports NVR settings from the storage device and applies to the NVR.
 - Uncheck the checkbox of an item(s) that you want to import. Only the other items than the selected one will be applied to the NVR.
 - You cannot retrieve the configuration file from another mode. In other words, in PnP mode, you cannot retrieve the manual setting information. In manual setting mode, you cannot retrieve the PnP setting information.
 - <Export> and <Import> settings should be used in the same software version.
- Load Factory Default : Restore the factory default settings of NVR. Uncheck the checkbox of an item(s) that you want to reset. Then, only the other items than the selected one will return to the factory default. If <Initialization> is selected, a confirmation dialog for "Load Factory Default" prompts. Press <OK> to initialize the system to the factory default.
 - After changing the mode, reboot to initialize. (PnP mode <-> Manual Setup Mode) (XRN-1610S only)

- Power off : If the power is off, the first alarm is generated. After checking the checkbox, if the <Apply> button is pressed, all event alarms that are set to the first alarm output are released, and then the first alarm cannot be selected by other alarm output.
 - If that function is set, the first alarm-out checkbox and all alarms in the alarm setup screen are deactivated, to Off.
- If you want to initialize the <Authority Setting>, you need to reset the password. In case you reboot, reset it the Installation Wizard and if not, use the guide screen to reset it.

Log Information

You can browse logs on the system and events.

Checking the system log

System Log shows log and timestamp on every system start up, system shutdown, and changes on system settings.

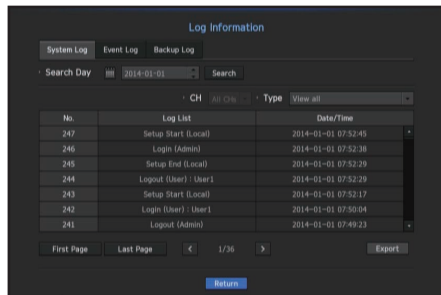

- Search Day : Click the Calendar icon to display the calendar window, or use the direction buttons to specify the search period of the system log.
 - For using the calendar, refer to "To use the calendar". (Page 27)
- Search : Specify the date and press this button to display the search result in the log list.
- Type : When there are too many logs, you can display logs of the desired format by selecting the type.
- Export : Save all the logged information recorded in the NVR into the storage media.

Checking the event log

You can search recorded events including alarms, camera events and video loss. It also shows the log and its timestamp.

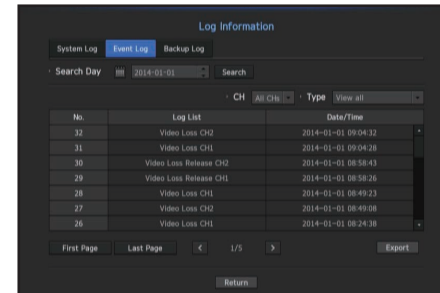

- Search Day : Click the Calendar icon to display the calendar window, or use the direction buttons to specify the search period of the system log.
 - For using the calendar, refer to "To use the calendar". (Page 27)
- Search : Specify the date and press this button to display the search result in the log list.
- Type : When there are too many logs, you can display logs of the desired format by selecting the type.
- Export : Save all the logged information recorded in the NVR into the storage media.

Checking the backup log

You can find out who backed up and the details (backup time, channel, device to use, file format, etc.).

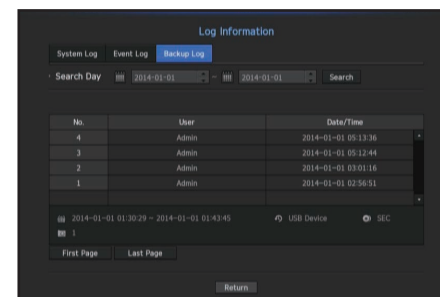

- Search Day : Click the Calendar icon to display the calendar window, or use the direction buttons to specify the search period of the system log.
 - For using the calendar, refer to "To use the calendar". (Page 27)
- Search : Specify the date and press this button to display the search result in the log list.

SETTING THE DEVICE

You can configure settings related to camera, storage media, monitor and text.

Camera

To register a camera

You can register a network camera for each channel and make connection between.

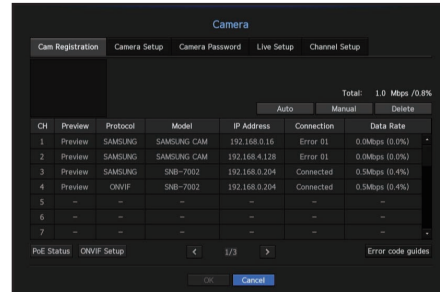
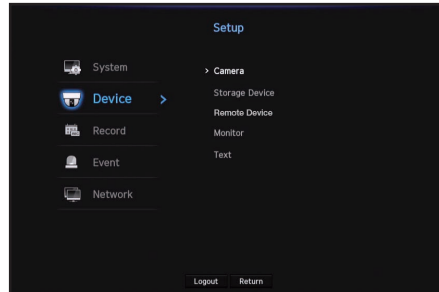

- Preview : View the video of the channel as a current image.
 - Camera searched with ONVIF does not provide previews.
 - Protocol : Show the protocol information of a registered network camera.
 - Model : Show the camera model name.
 - IP Address : Display the IP address of a network camera.
 - Connection : Display the connection status.
 - Data Rate : Displays the total amount of data received by the channel.
 - PoE Status : Displays connected PoE status information.(XRN-1610S)
 - ONVIF Setup : You can additionally set up ONVIF protocol camera.
 - Error code guides : You can check the details of generated error codes.
- ✍️ ▪ If the NVR has been initialized, it may not connect to cameras. Configure the network settings first and add cameras. For more information on network settings, refer to "Network Configuration". (Page 45)

If you want to register a camera in PnP mode (XRN-1610S)

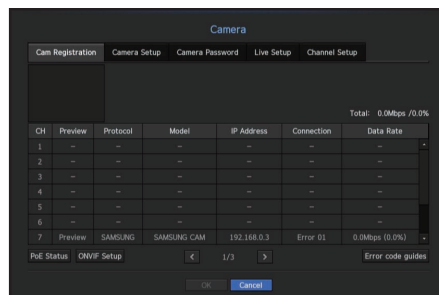

- ! ▪ When you connect a camera in PnP mode, the initial ID, password and DHCP mode should be set in advance.
- Samsung cameras are registered for Samsung protocols and other cameras are registered by using the Onvif protocol.
- In PnP mode, you cannot connect a device that runs the DHCP server in PoE port or camera setting port. (Ex: hub)

To auto-search for and register a network camera

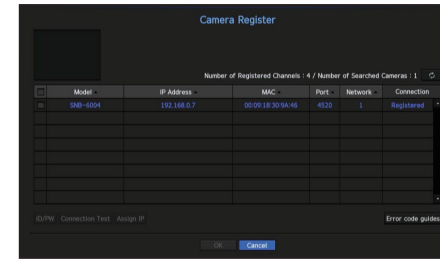

1. In the <Cam Registration> field, click on the <Auto> button.
2. Search for a network camera connected.
 - An already registered camera will be marked in blue in the list.
 - If you search for the camera again or if the IP is an old IP that was not assigned by the DHCP server (such as -192.168.1.100), then press the <Refresh> button to check if a new IP has been assigned. If the IP is still the same, then select Assign IP to assign the IP manually.
3. Select a camera from the camera list to see a preview of its current video feed.
 - Camera searched with ONVIF does not provide previews.
4. Check the checkbox next to a network camera that you want to connect to.
 - You can select all of the network cameras in the list and provide <ID> and <Password> all at once.
 - Click a header at the top of the list to sort the list according to that header.
- ! ▪ Registering camera with user account other than admin may restrict camera function.
 - When you change the camera ID/password in the camera web viewer, if the camera is already registered in NVR, you also have to change the camera ID/passowrd information registered in NVR.
5. Click on the <ID/PW> button to enter the selected network camera's <ID> and <Password>.
6. Press the <Connection Test> button to make a connection to a camera.
7. Press <Register> to register the selected camera.

To manually search for and register a network camera

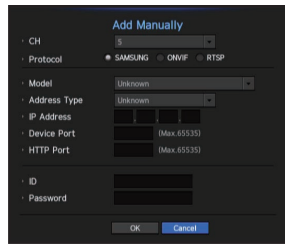

- In the <Cam Registration> menu, click on the <Manual> button.
- The manual search window will appear.
- Select a channel and protocol used to connect to a camera.
The input items may differ depending on the selected protocol.
 - SAMSUNG : Comply with the internal network protocols adopted by Hanwha Techwin.
 - ONVIF : Means the camera supports ONVIF protocols. When connecting a camera that its name cannot be found from the list, select <ONVIF>.
 - Time difference between the ONVIF camera and NVR exceeds more than 2 minutes, the camera cannot be connected. In this case, synchronize the ONVIF camera's time to the NVR or set times of both camera and NVR to a same NTP server (if in the same time zone), or make the NVR an NTP server.
 - RTSP : Comply with RFC 2326, one of "Real Time Streaming Protocol (RTSP)" for real-time streaming.
- If you select the <SAMSUNG> protocol, check options as necessary.
 - Model : Select a camera model.
 - Samsung Network Camera/Encoder : Means the camera/encoder supports Hanwha Techwin's SUNAPI, SVNP protocol. When connecting a camera that does not appear in the camera list, select Samsung Network Camera/Encoder.
 - However, you must select the correct model name of the camera, if it's in the list. Some of obsolete camera models may not be supported.
 - The below models are discontinued. If you register them with ONVIF, some camera functions will be restricted or cause errors. It is recommended you register the Samsung protocol.
 - SNB-2000, SNB-3000, SNC-B2315, SNC-B2331, SNC-B2335, SNC-B5368, SNC-B5395, SNC-B5399, SNC-570, SNC-1300, SND-460V, SND-560, SND-3080, SND-3080C, SND-3080CF, SND-3080F, SND-3081, SNP-3301, SNP-3301H, SNP-3350, SNP-3370, SNP-3370TH, SNP-3750, SNV-3080, SNP-3430
 - Address type : Select an address type of the camera.
 - Address type can be different depending on connected product model.
 - Static(IPv4)/Static(IPv6) : Used to provide the IP address of the camera manually.
 - iPOLiS DDNS : This is available only if the camera is registered with the iPOLiS DDNS(www.samsungipolis.com) server. Provide the registered domain for DDNS ID.
 - Ex) http://www.samsungipolis.com/snb5000 → provide "snb5000" for iPOLiS DDNS
 - URL : Used for URL address input.
 - Refer to the user manual of the connected camera and check the DDNS specification that is supported by the camera.
 - IP Address : Provide the IP address of the camera.
 - Device Port : Provide the device port of the camera.
 - HTTP Port : Provide the HTTP port of the camera.

- ID : Provide the ID of the camera that you want to register.
 - Password : Enter the password of the camera to be registered.
- Select <ONVIF> or <RTSP> for the protocol and enter your input for each field appears.
 - ONVIF Address / RTSP URL : Enter the camera's RTSP access address that supports ONVIF or RTSP. For more information about the RTSP address, refer to the manual of each applicable network camera.
 - ID : Enter the ID for accessing via ONVIF/RTSP protocol.
 - Password : Enter the password for accessing via ONVIF/RTSP protocol.
 - Mode : If <More Detail> button clicked, setup window will appear. Select a mode that is supported by the network camera in RTSP connection mode.
 - TCP : The connection type with the network camera will switch to "RTP over TCP".
 - UDP : The connection type with the network camera will switch to "RTP over UDP".
 - HTTP : The connection type with the network camera will switch to "RTP over TCP (HTTP)".
 - HTTPS : The connection type with the network camera will switch to "RTP over TCP (HTTPS)".

If you want to check the error details of camera registration

If you failed to register a camera, the reason for the failure will be displayed.

- Connection failed due to unknown error.** : This message appears if the camera has failed to be registered due to unknown connection status.
- Due to the camera account locking, access has failed.** : When you enter a wrong ID/password 5 times to login to the camera account, this message is displayed. Try to log in again after 30 seconds. If the same message appears, you may need to check whether someone has tried to access your camera account from the outside.
- Connected successfully.** : This message appears if the camera is connected successfully.
- Incorrect model information. Provide the correct model information.** : This message appears if the model information provided for registering the camera is incorrect.
- Authentication has failed** : This message appears if the ID or password provided for registering the camera is incorrect.
- Connection has failed due to excessive concurrent users.** : This message appears if the concurrent user count exceeds the upper limit.
- Connection has failed due to incorrect HTTP port information.** : This message appears if the HTTP port number of the camera is invalid.
- Connection has failed. Unknown connection status.** : This message appears if the camera has failed to be connected due to a unknown error.
- User Model Modification** : When registering a new camera, it is named according to the device's default if user set the model to <Samsung Network Camera/Encoder>. In case if automatic registration fails, user can change the model name of camera to be registered.

To edit camera profile

When a camera is added for the first time, it is added as the default profile of H.264, H.265 and MJPEG in order temporarily.

To change its profile, refer to "**Setting the network camera's recording profile**" (Page 42) or "**Live Setting**" (Page 36).

- In case of NVR, if you set 3 different profiles for live, recording and network profile, one camera will produce video streams accordingly, having different stream formats. Especially, note that the live profile may vary depending on the used screen split mode.
- For cameras, if applied with one profile only, the produced frame rate is fixed as the profile specifies; if applied with multiple profiles, produced video stream's frame rate is not guaranteed. For example, if applied with 2 profiles of 30fps, the camera may transmit streams at 20fps.

ONVIF Setup

In the bottom of the camera addition screen, click on the <ONVIF Setup> button to set additional settings for cameras with the ONVIF protocol.

- You can change the information only if the user account (camera account used for camera registration) is used to read the user information and a connection is made with the admin privilege.

Profile

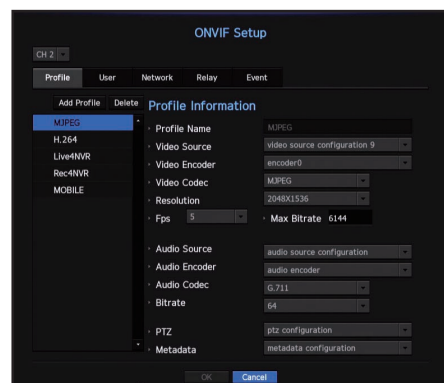

- CH : It shows the list of registered camera with the ONVIF setting.
- Add Profile : You can add camera profile. After adding a profile, click on the <OK> button to add it to the list.
- Delete : After selecting the profile to delete, click on the <Delete> button to delete the selected profile.
- Profile information : You can set the details of the selected profile.

After finishing setting each item, click on the <OK> button to save changes.

User

- Add User : You can add a camera user. After adding a user, click on the <OK> button to add them to the list.
- Delete : After selecting the user to delete, click on the <Delete> button to delete the selected user.
- User Information : You can set the details of the selected user.

Network

You can set the details of the network.

- IP Type : Select from either the IPv4/IPv6 IP types.
- DHCP : Select whether to use the DHCP.
- DNS / NTP Server : Only if the DHCP setting is <ON>, the DHCP checkbox will be activated.
 - If the DHCP is checked, you can manually enter the IP address.

Relay

You can set details of the relay.

- Digital Output : You can select a digital output channel.
- Relay Mode : Select either bi or mono stable modes.
- Relay Idle State : Select either open or closed relay standby modes.
- Delay Time : Select the relay operation waiting time.

Event

You can set details of the event.

- Available events (camera) : It shows the list of all the events supported by a camera by using the ONVIF protocol.
- NVR supported events : You can map the list of events supported by a camera to events that the NVR can detect. There is no default value. It only shows the value sent by a camera.

Camera Setting

You can change the video settings of a registered network camera for each channel.

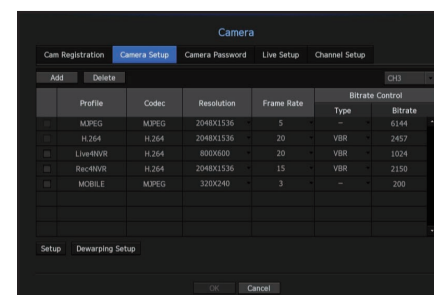

- Add : You can add camera profile. Click on the Add button to launch the addition window. Enter the information and click on the <OK> button to add it to the list.
- Delete : You can delete the selected profile from the list.
- Select Camera : Select the camera channel to change the video transmission settings.
- Profile : Show a video profile for the connected camera.
- Codec : Show the codec information for the selected profile.
- Resolution : You can change the resolution of the selected profile.
- Frame Rate : You can change the frame rate of the selected profile.
- Quality : You can change the video quality of the selected profile.
- Bitrate Control : You can change the bit rate for video transmission of the selected profile.
- Type : You can choose CBR or VBR of the selected profile.



- If you change the settings of a specific profile for each model, the effective range of the frame rate may be changed accordingly. Ex) if you set the frame rate of the first profile to 30fps, the send rate of the second profile will be changed to 15fps.
- Menu options other than codec, resolution and transmission rate can be configured in the settings menu of the network camera.
- If you change the current profile settings, you may encounter an interrupted playback on the recording or live screen for a certain time.
- Changes made in Camera Setup page are applied immediately, while changes made through the camera's web page may require up to 3 minutes.

Setup

In the bottom of the camera setting screen, press the **<Setup>** button to set your camera while watching the live video of the selected camera.

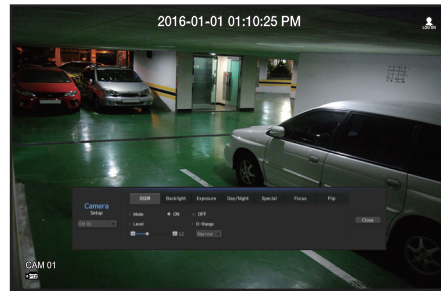

- SUNAPI (Samsung Unified Network API) : Camera that supports the communication protocols provided by Hanwha Techwin
 1. Camera supporting SUNAPI.
 2. A camera connected with admin privileges.
 3. A camera connected to Samsung protocols.
 In the above cases, you can use the function.
- For more details on camera settings, refer to the camera user manual. Settings and operational spec vary depending on each camera.
- This function is not supported in some models.

SSDR

If there is a significant difference between the dark and the bright areas, increase the brightness of the dark areas to maintain the level of brightness of the entire area. Mode, level, D-Range can be set.

Backlight

You can view both bright and dark areas. Mode, WDR level, WDR black/white levels can be set.

Exposure

You can adjust the exposure of your camera. Brightness control, shutter, SSSNR, Sens-up, **IRIS/lens**, and **AGC** can be set.

Day/Night

You can change the mode to adjust the color and contrast. Mode, switching time, brightness change, alarm time, alarm input/output, negative color, daytime/nighttime switching and simple focus, and activation time can be set.

Special

DIS (shaking compensation), use of Defog levels can be set.

Focus

You can adjust the focus of you camera's video. Items of Simple Focus and Focus-Initialize Setting can be set.

Flip

Mirror and flip modes can be set. After finishing with setting camera, click on the **<Close>** button to move back to the previous screen.

Dewarping Setup

Press **<Dewarping Setup>** at the bottom of the camera settings screen and a distortion correction settings window for each channel is prompted.

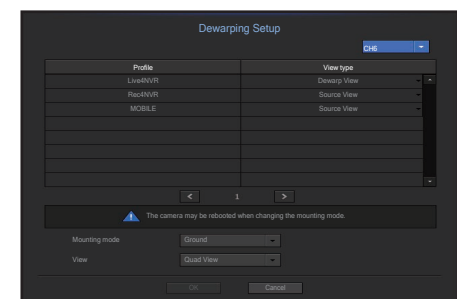
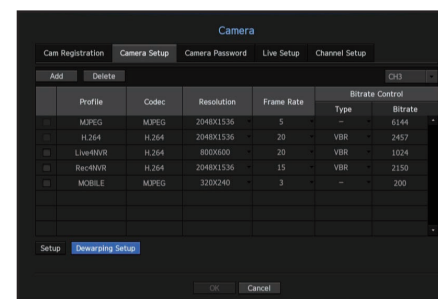

- Profile/View type : You can select the view type of profiles, except for fixed profiles (SourceMJPEG, SourceH264, DewarpMJPEG, DewarpH264) whose settings can't be changed, in the profile list on the distortion correction settings pop-up window.
- Mounting mode : You can change the fisheye installation type. You can select a view mode from among CEILING/FLOOR/WALL depending on the installation location.
- View : You can change the fisheye view mode of the current screen according to each split section.



- If there is no camera registered in the NVR that supports fisheye view, **<Dewarping Setup>** will not be available.

Setting Camera Password

You can change the passwords of all registered cameras at once.

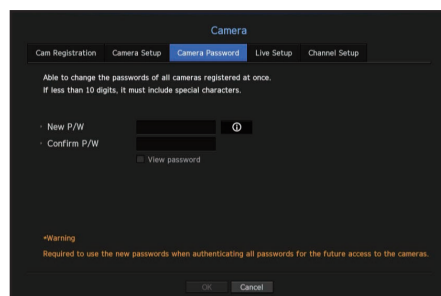

- New P/W : Input a new password according to the password setting rules.
- Confirm P/W : Input the new password again.
- If you click <  >, a basic guide for password setup is displayed.
- If <View password> is selected, the password is no longer hidden on the screen when you type it.
- A camera password registered with ONVIF and RTSP cannot be changed.

Password setting guide

The length and limitations of a password are as follows.

- Uppercase letters/lowercase letters/numbers/special characters, containing at least 3 out of the 4 character types mentioned: 8 or 9 digit combination
- Uppercase letters/lowercase letters/numbers/special characters, containing at least 2 out of the 4 character types mentioned: 10 to 15 digit combination
- The password shall not be identical to the user ID.
- To enhance security, it is not recommended to use repeated digits or letters, or keyboard patterns as a password.
- Special characters accepted for a password : ~!@#\$\$%^*()_+={|}[].?/

Live Setting

You can change the live transfer settings of the network camera.

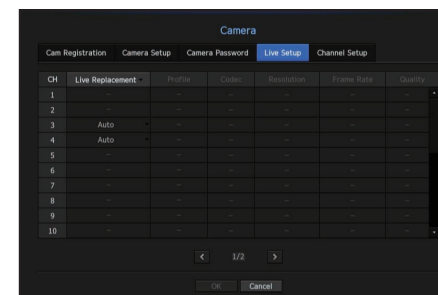

- Live Replacement : You can select the live profile setup mode.
 - If you select <Manual>, the profile setup items are enabled, and you can change settings manually.
 - Auto : In case of split mode, the profile for live monitoring shows the Live4NVR profile(basic: H.264 800*600 30fps) created at the time of registration and it automatically selects the second profile in case of single mode.
 - Manual : Live monitoring is performed with the profile selected by the user from the registered camera profiles.
 - Record : Live monitoring is performed with the profile set for recording.
- Profile : You can select the video profile of the connected camera setting.
- Codec : [Show the codec of the selected profile.](#)
- Resolution : Show the resolution of the selected profile.
- Frame Rate : Show the frame rate of the selected profile.
- Quality : Show the quality of transfer video of the selected profile.

Channel Setting

You can configure the video settings for each channel.

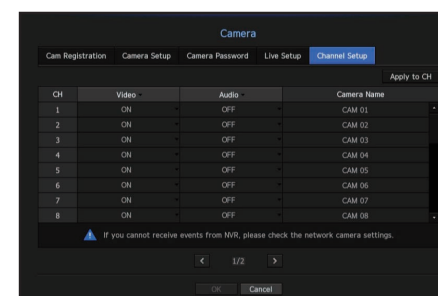

- Apply to CH : If you select <Apply to CH>, the "Apply to CH" confirmation window will appear. After selecting channels that the settings will be applied to, click on <OK> to apply them to the selected channels.
- Video
 - <ON/OFF> : You can turn ON/OFF the selected channel's camera.
 - <Covert1> : Shows information other than the video of the selected channel. For privacy protection, it does not display the video while the recording continues.
 - <Covert2> : Shows nothing but an empty screen while the recording continues.

-  If the channel is set to <Covert1> or <Covert2> mode, the channel's sound is not hearable. However, the channel's sound is recorded if its Audio setting is set to <ON>, even the sound is not heard in Live mode.

- Audio
 - If set to <ON>, you can turn the audio of the channel ON/OFF on the Live screen.
 - If set to <OFF>, the channel's audio is off on the Live screen and not recorded.
- Camera Name : Provide a camera Name.
 - You can enter up to 15 characters including space.

Storage Device

You can check information on storage devices.

Device/Format

You can check storage devices and their capacity, usage as well as status. HDD, E-SATA, iSCSI and USB (memory or HDD) can be connected as a storage device.

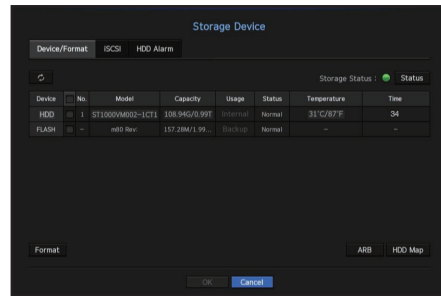

- Storage Status : Displays the working status of a storage device.
 - Red : Displays the situation of video loss.
 - Green : Displays the normal situation without video recording losses.
 - Status
 - Total bps : Displays the current rate of recording.
 - Present Loss : Displays the current recording loss rate.
 - Worst Loss : Displays the maximum amount of losses up until now.
 - If the recording loss persists, please refer to the "**Troubleshooting**" in order to perform checks. (Page 78)
- No. : You can check the designated number for the built-in HDD.
 - If you want the find out about the location corresponding to the HDD number, refer to the <HDD Map>.
- Capacity : Displays the amount of storage device use and the full capacity.
- Usage : Designate the purpose of use for a storage device. (However, only the display function is available for iSCSI and ARB)

- Status : Displays the current working condition of a storage device. For inspection or replacement of HDD alarms, please refer to "**HDD Alarm Setting.**" (Page 39)
 - Normal : It is displayed during normal operation.
 - Inspection : Operating with partial problems.
 - Replacement : It is displayed when you can no longer use it.
- Temperature : You can check the temperature of the HDD mounted in the NVR.
- Time : Displays the use time of an HDD.
- Format : Select a device and click on format after which a format confirmation window appears. Click on the <OK> button to format the selected storage device.

- 
 - Formatting will delete all the recording data that has been saved. Be careful.
 - While formatting is ongoing, you cannot record video.
 - Do not remove a formatting device until it is finished.

- ARB : Video that was not recorded due to a camera disconnection can be backed up after the connection with the camera is re-established. Press the button and an <Auto Recovery Backup> window is opened.
 - ARB storage : Select a storage device to be set to ARB.
 - ARB channel Selection : Select a channel to run the ARB.
 - You can select multiple channels. If you select <All CHs>, all channels will be selected.
 - ARB bandwidth : Select a bandwidth for the ARB function.

- 
 - Only our camera products support the ARB function. The SD card recording function should be used.
 - To use the ARB function correctly, both the camera and NVR should be time synchronized with the time server. (Page 27)
 - ARB function is activated when NVR starts/when the channel camera set is reconnected/when an NVR recording missing section recurs at regular intervals after NVR starts.
 - NVR recording missing section that can be restored with the ARB function is for 24 hours backwards from the point when the ARB function is activated.
 - You can check which channels have ARB function activated through the message on each channel screen that is displayed when selecting a channel. (Page 20)

- HDD Map : You can check the location according to the assigned number for the HDDs installed inside.
 - Refer to this when servicing or installing an additional HDD.

- 
 - Do not add or remove an HDD while NVR is running.

Connecting the iSCSI

If you connect the NVR with an iSCSI device, you can search, connect and disconnect the iSCSI device.

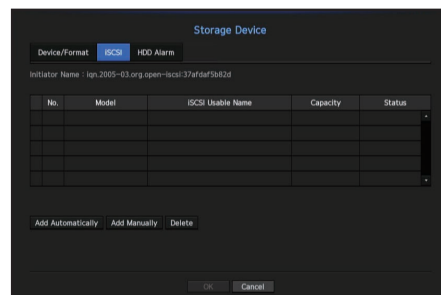

- **iSCSI Usable Name** : It displays the name of iSCSI in compliance with the iSCSI protocol format.
- **Capacity** : It displays the currently used amount/total capacity of iSCSI devices.
- **Status** : Displays the status of an installed iSCSI device.

List of products supported

Promise Technology vessRAID 1740i / 1840i / 2600i 1ea JBOD 3ea

Adding an iSCSI device automatically

1. In the iSCSI window, click on the **<Add Automatically>** button.
2. On the Auto Add screen, enter the IP address and the connecting port, and click **<Search>**.
3. In the **<iSCSI Usable Name>** list, click on a device to add.
4. After entering ID/password, click on the **<OK>** button.

Adding an iSCSI device manually

1. On the iSCSI screen, click **<Add Manually>**.
2. On the Manual Add screen, enter the IP address, the connecting port, the ID and the password, and click **<OK>**.

Canceling registration of iSCSI devices

1. In the **<iSCSI Usable Name>** list, select an iSCSI device to delete.
2. Click on the **<Delete>** button to launch the Delete window.
3. If you click **<OK>**, the iSCSI device is removed from the list.

- For iSCSI equipment, use network port 2.
- When using a hub to connect an iSCSI device with NVR, make sure to use the GIGA hub and to use an independent network to save data normally.
- When you perform single directional CHAP authentication in vers. RAID, an iSCSI device in compliance with the NVR, you need to use the iSCSI Manual Add function to make a connection to iSCSI.
- If multiple NVRs try to access a single iSCSI device, it can cause a problem.
- When the NVR is connected to an iSCSI device, if you change the iSCSI equipment setting, a problem can occur.
- A HDD to be mounted in vess RAID should be listed in the RAID compatibility list.
- It is recommended that you configure each volume for an iSCSI device with a maximum of 16 HDD.
- When you register an iSCSI device in the NVR for the first time, you need to format it first.
- The iSCSI lun mapping function is supported.
- If you activate the lun mapping function in the iSCSI device, the lun can only be connected to an NVR which is mapped.

Use Joystick

The SPC-2000 joystick is operated as follows:

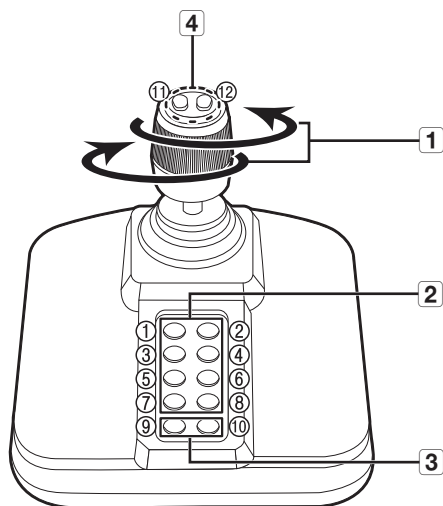

Name	Function
1	Up/Down/Left/Right In PTZ mode, the camera can be panned, tilted, and controlled in 8 directions The webviewer only supports the PTZ mode. In Screen mode, the top/bottom/left/right tile can be selected.
	Rotation In PTZ mode, the screen is zoomed in when it is rotated clockwise and zoomed out when it is rotated counterclockwise.
2	1~8 In PTZ mode, presets number 1~8 are run. Screen mode works as follows. 1: Changing live layout / 2: Search 3: Backup / 4: Zoom mode 5: Freeze mode / 6: Audio 7: Alarm / 8: Rec
3	9 It allows to exit PTZ mode in PTZ mode. The webviewer won't be able to stop the PTZ on its own. This is used to change to PTZ mode from screen mode.
	10 It allows to exit PTZ mode in PTZ mode. The webviewer won't be able to stop the PTZ on its own.
4	11, 12 In PTZ mode, Focus Near/Far operation is run. When using the screen mode, the same operations can be done by moving the mouse.

- More than one mapped lun should be available to connect to the initiator when using lun mapping.

HDD Alarm Setting

For HDD malfunctions, you can set the inspection alarm output terminal, the replacement alarm output terminal, the iSCSI alarm output terminal and the alarm time.

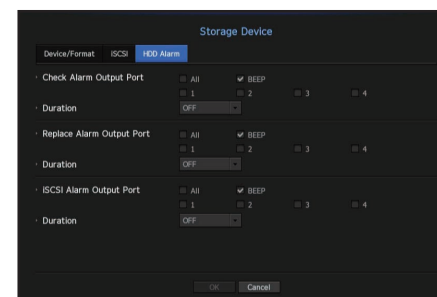

- Alarm
 - If <All> was selected, both beep sound and alarm signal through rear side ports will output.
 - If <BEEP> was selected, a beep will sound.
 - Alarm signal will output through the alarm out port on the rear side when selected <1>, <2>, <3>, and <4>.
- Check Alarm Output Port : If HDD generates check alarm, the alarm signal will output to the specified alarm output port.
- Replace Alarm Output Port : If HDD generates replace alarm, the alarm signal will output to the specified alarm output port.
- iSCSI Alarm Output Port : If a connection to your iSCSI device is lost, a signal is sent to the designated alarm terminal.
- Duration : Sets the alarm duration for the alarm signal and beep sound.

- <Check> status means that the HDD is operating but it has problems that require technical examination. (🔍) appears on the Live screen.
 - <Replace> status means that the HDD has defect and requires immediate replacement. (🔧) appears on the Live screen.

Remote Devices

You can adjust the ID for a remote control to be used in connection with NVR.

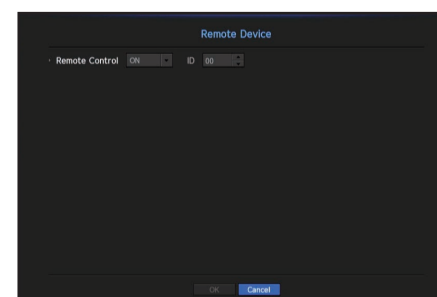

- Remote control: Select whether to use a remote control.
- ID: Select an ID number linked to a [remote control](#).
If the remote control ID does not match, it will not operate properly.

- To change the remote control ID, refer to "[Changing the Remote Control ID](#)". (Page 8)

Monitor

You can set the information displayed on the monitor as well as the output system.

Monitor settings

You can configure the monitor output-related settings including the displayed information, dwell time and output system.

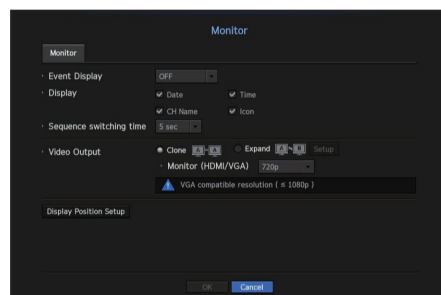

- **Event Display** : Sets the dwell time of the event channel display on the monitor when an event occurs. If you set **<Continuous>**, it will keep displaying until you cancel it.
- **Display** : Displays only checked items on the monitor screen.
- **Sequence switching time** : Set the automatic switching time for the segmented screen in live mode.
- **Video Output** : Selects either **<Clone>** or **<Expand>** mode to output the video, and sets the resolution of **<HDMI>** and **<VGA>**.
 - Clone mode: You can set the resolution of the main monitor (HDMI) and the sub monitor (VGA) as identical to each other.
 - When operating in copy mode, if the resolution is set to a value exceeding 1080p, no image will be displayed on the sub monitor.
 - Expand mode: You can separately set the resolution of the main monitor (HDMI) and the sub monitor (VGA).

To set an expansion monitor

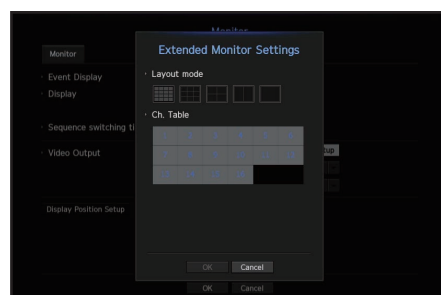

1. Select the Expand mode, then **<Setup>** button to change the layout of the expansion monitor is enabled.
2. Select split mode in the layout mode.
3. Select as many channels on the channel table as the number of channels selected in layout mode, and you can view the applicable screens on the monitor.

- If the new resolution does not fit the monitor, the output will not be displayed normally. In this case, wait until the monitor returns to the default resolution and then change to a different resolution.
- Specify the event display time and dwell time in consideration of the video delay depending on the network environment.
- You can configure the settings of the profile used to display the live image on the expansion monitor in **"Live Streaming"**. Please refer to **"Live Streaming"**. (Page 47)
- Live display of the expansion monitor supports up to 1280 X 720 resolution.

To adjust the display position

Some monitors may not display information (camera name, icon, time information, etc.) about the NVR, depending on the condition. Then, you can change the display position of the data.

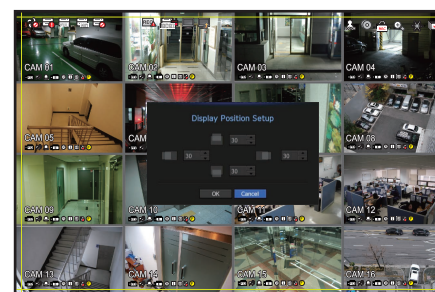

1. From the monitor setup menu, select **<Display Position Setup>**.
2. Using the number button to adjust the screen that is cut off.
3. Press **<OK>**.

Text

Device and events can be set up.

Device Settings

No.	Device	Use	CH	Port	Encoding type
1	TEXT 01	Not Use	None	7001	US-ASCII
2	TEXT 02	Not Use	None	7002	US-ASCII
3	TEXT 03	Not Use	None	7003	US-ASCII
4	TEXT 04	Not Use	None	7004	US-ASCII
5	TEXT 05	Not Use	None	7005	US-ASCII
6	TEXT 06	Not Use	None	7006	US-ASCII
7	TEXT 07	Not Use	None	7007	US-ASCII
8	TEXT 08	Not Use	None	7008	US-ASCII

Relevant values of a device connected to NVR can be set.

- **Device** : Enter the user's desired name
- **Use** : Select whether or not to use
- **CH** : Select a channel to add a device from a channel table.
- **Port** : Display a port number that is set

- Encoding type : Select an encoding type to use from a list.
 - You can select starting and ending character strings.

 General characters, special characters, and Hex codes (e.g. 0x12, 0x34) can be used for character strings.

 Equipment connected to NVR uses TCP/IP communication protocol.

Event Settings

You can set up event keywords.

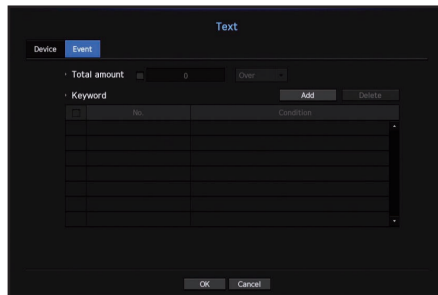

- Total amount : Set a total amount condition to receive alarms.
- Keyword : If the **<Add>** button is clicked, a screen to add keywords pops up. If you select one of the added keywords to delete and click the **<Delete>** button, the selected keyword will be deleted.

SETTING THE RECORDING

You can setup scheduled recording, event recording and other recording related settings.

Recording Schedule

Make your reservation on a date and time to schedule the recording on specified time.

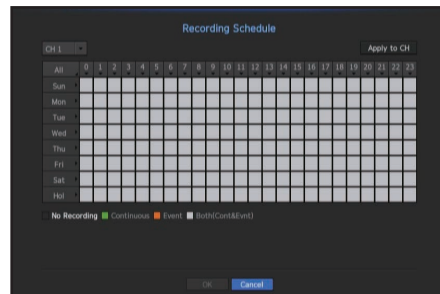
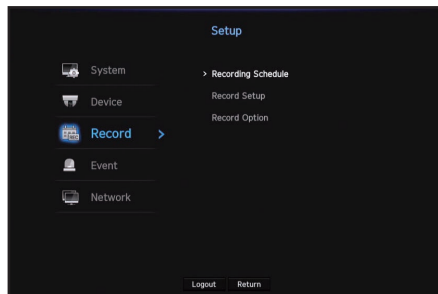

- All : The entire time range (Monday through Sunday including holidays, AM 0~ PM 23) will be reserved with the same recording schedule
- Apply to CH : If you select **<Apply to CH>**, the "Apply to CH" confirmation pop-up window will appear. After selecting channels that the settings will be applied to, click on **<OK>** to apply them to the selected channels.

 Event recording and scheduled recording starts about 3 seconds prior to the event/schedule for guaranteed recording.

Record setting by the color

Color	Function	Description
No Color	No Recording	No schedule / event recording
Green	Continuous	Scheduled recording only
Orange	Event	Event recording only
White	Both(Cont&Evt)	Both scheduled / event recordings

Each press of a selected cell will cycle through **<No Recording>**-**<Continuous>**-**<Event>**-**<Both(Cont&Evt)>**.

Recording performance spec for the HDD condition

No	HDD condition	Receiving (Mbps)	Recording (Mbps)	
			Internal	iSCSI
1	HDD for CE	256	256	-
2	HDD for CE	100	100	-
3	HDD for Server	256	256	256
4	HDD for Server	100	100	100

Record Setting

You can set resolution, FPS, and quality of recordings by channel, and by recording type of standard / event. You can check frame rates and data transfer amount of Full Frame and Key Frame recordings for each channel, and set the transfer limit for recordings.

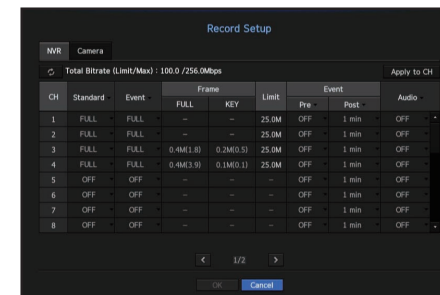

- Apply to CH : If you select **<Apply to CH>**, the "Apply to CH" confirmation window will appear. After selecting channels that the settings will be applied to, click on **<OK>** to apply them to the selected channels.
- Standard, Event : Configures Standard recording and Event recording.
 - FULL : Records all frames fed by the camera.
 - KEY : Records only key frames fed by the camera. Actual recording rate may differ from camera settings. In general, 1 to 2 frames per second are recorded.
 - OFF : No recording is made.
- Frame
 - FULL : Shows the amount of data for all the scene recordings.
 - KEY : Shows the amount of data for the main scene recordings.
- Limit : Set the amount of data allowed for input for each channel.

menu setup

- Event : When an event occurs, you can set which point you will start or stop recording.
 - Pre : When an event occurs, recording will be started regardless of the time set.
If you set it to five seconds, recording will start at five seconds before an event occurs.
 - Post : When an event occurs, recording will continue after the time set.
If you set it to five seconds, recording will continue for a further five seconds after an event is finished.
- Audio : Specify whether to record the sound received from the camera or not.

- ✎ If a channel's data transfer exceeds defined allowed limit, then it may affect to other channels, and may force switching to <KEY> recording even when the channel is configured to <FULL> recording mode. For Key Frame recording channels, the icon for limited recording appears on the live screen's top side.
But if the sum of the limits is below the max limit, you can still receive the entire frames despite exceeding the permitted bitrates for each channel.
- A channel displayed in yellow indicates that the recorded data is not being transferred from the camera and that the recording is being performed temporarily using another profile on the camera.
Check the channel information to see the applied profile to the channel listed in yellow.
A channel displayed in orange indicates that the amount of inputted data is greater than the permitted data amount.
In this case, it is impossible to record all of the incoming frames.
Instead, only part of the frames (1 or 2 frames per second) can be recorded. To resolve this issue, you must set the permitted data amount to be greater than the amount of inputted data.
Refer to notes on "Record status". (Page 21)

Setting the network camera's recording profile

You can configure the video profile settings for instructing the network camera (connected to each channel) to make recording.

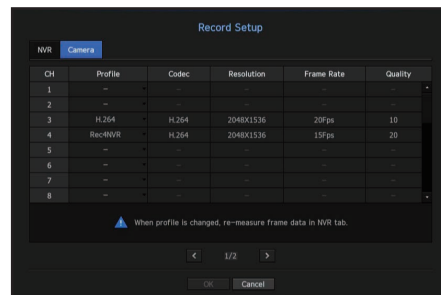

- ✎ You can configure the settings only for the profiles that are supported by the camera.
- If the profiles used for recording and network are different, camera's video feed may not comply with the frame rate as specified in the camera.

- Profile : Select a record profile for the connected camera.
- Codec : Show the codec information for the selected record profile.
- Resolution : Display the resolution for the selected record profile.
- Frame Rate : Display the frame rate for the selected record profile.
- Quality : Display the video quality for the selected record profile.

Record Option

When the HDD capacity is full, you can set whether to stop recording or start overwriting.

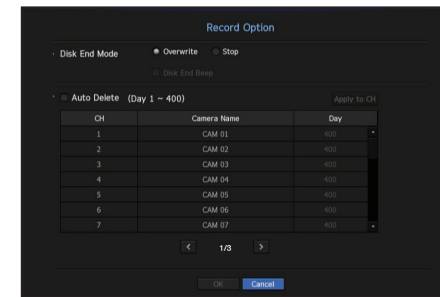

- Disk End Mode : Select a HDD repetitive recording type.
 - Overwrite : If the HDD is full, this will overwrite the existing data and keep recording.
 - Stop : If the HDD is full, this will stop recording automatically.
 - Disk End Beep : If you select <Stop> for the disk end mode, this button will be active. Specify the use of beep when the HDD recording ends.
If you check it, the beep will sound on the disk full and the recording stops.
 - Auto Delete : If you check this option, the period list box is active. Specify the deletion period to delete any earlier data than the specified date. However, you can search for data from the current time to the selected date.
 - You can select a channel and set a different recording duration for each channel.
 - Apply to CH : If you select <Apply to CH>, a confirmation dialog window is opened.
Select a channel to apply the applicable settings then press <OK>. The settings will be applied to the selected channel.
- ! If you press <OK> when you have completed your settings, all the existing data earlier than the specified period will be deleted automatically. So it is recommend to backup the previous data if necessary for later use.

SETTING THE EVENT

You can make the setup for record in case of sensor detection, camera event or video loss detection.

Sensor Detection

You can set the sensor's operating condition and connected camera, as well as alarm output and its duration.

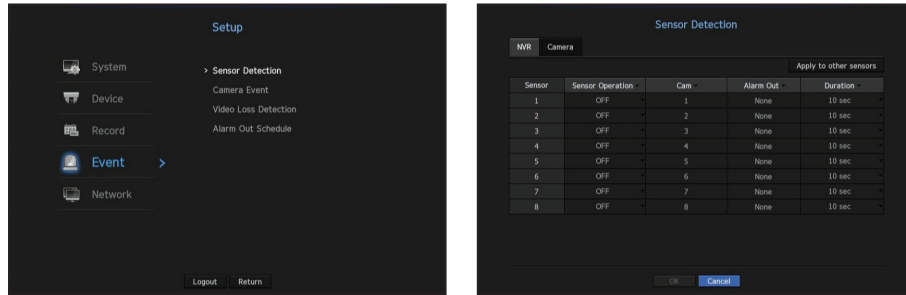

- Apply to other sensors : If you select <Apply to other sensors>, the "Apply to other sensors" confirmation window will appear. After selecting channels that the settings will be applied to, click on <OK> to apply them to the selected channels.
- Sensor Operation : Sets the operation mode of sensors.
 - In the <Camera> tab, you can set whether or not to use a sensor.
 - <N.O (Normal Open)> : Sensor is opened. If the sensor is closed, it generates alarm.
 - <N.C (Normal Close)> : Sensor is closed. If the sensor is open, it generates alarm.
- Cam : Select a channel to be connected to the sensor. If selected camera, "Cam Preset setup" window appears. Select a channel and setup the preset.
 - Preset setup can be done in PTZ mode.
- Alarm out : Sets the alarm output method.
 - For further information on alarm output, refer to "HDD Alarm > Alarm". (Page 39)
- Duration : Sets the duration of alarm signal and alarm sound.
 - If you select <Camera> tab, you can configure the sensor operation settings of the network camera connected to each channel.
 - If the connected network camera that has configured the alarm in/out settings triggers an alarm, NVR will perform the alarm out.

Camera Event

You can set the activation of events (motion detection, video analysis, audio event) sent from the camera, alarm output method and alarm time.

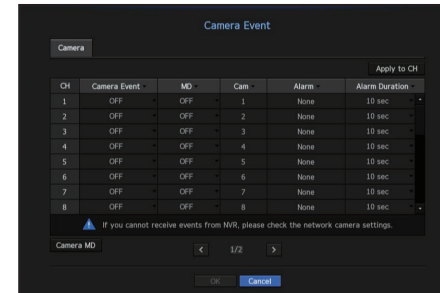

- Apply to CH : If you select <Apply to CH>, the "Apply to CH" confirmation window will appear. After selecting channels that the settings will be applied to, click on <OK> to apply them to the selected channels.
- Camera Event : Select whether to use an event detection.
- MD : Select whether or not to use motion detection from camera.
- Cam : Select an event detection channel. If you select a camera item, the "Camera preset" screen will appear. Select a channel to connect and set the preset.
 - You can set the preset in PTZ mode.
- Alarm : Select the method for alarm output.
 - For more details, refer to "HDD alarm > Alarm". (Page 39)
- Alarm Duration : Set the duration of alarm.
- Camera MD : You can set the detailed setting of motion detection for a network camera connected.

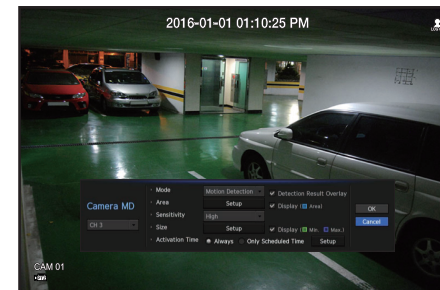

- Mode : Set the motion detection mode.
- Area : Click on <Setup> and when the detailed setup menu appears, set the motion detection area.
- Sensitivity : Set the sensitivity for motion detection. (very low/low//medium/high/very high).
- Size : Click on <Setup>. When the detailed setup menu appears, set the max/min size of the object to be detected.
- Activation Time : Select the operation time of motion detection.

After finishing with setup, click on the <OK> button to move back to the previous screen after saving the setup.

Video Loss Detection

You can set the camera so that the camera can trigger the alarm if it is disconnected or the video is lost due to unstable network connection.

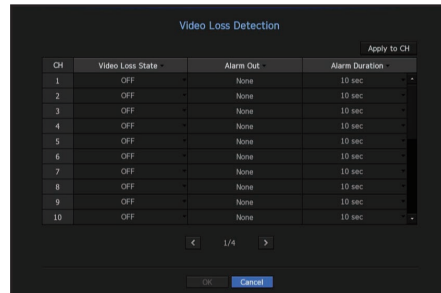

- Apply to CH : If you select <Apply to CH>, the "Apply to CH" confirmation window will appear. After selecting channels that the settings will be applied to, click on <OK> to apply them to the selected channels.
- Video Loss State : Specify the use of video loss detection.
- Alarm Out : Select an alarm output method.
 - For further information on alarm output, refer to "HDD Alarm > Alarm". (Page 39)
- Alarm Duration : Specify the duration of the alarm output with the beep.

Alarm Out Schedule

You can set the conditions and operating hours for scheduled alarms.

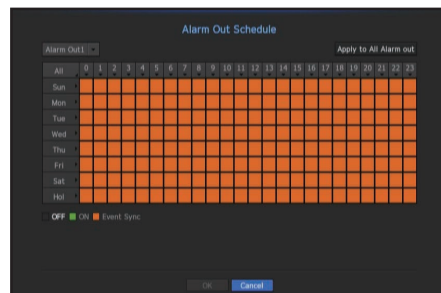

- Alarm Out : Sets the alarm output method.
 - For further information on alarm output, refer to "HDD Alarm > Alarm". (Page 39)
 - <ON> : Marked in green, and always generates alarm on scheduled time.
 - <OFF> : Marked in black, no alarm is generated even if an event occurs.
 - <Event Sync> : Marked in orange, generates alarm only when an event occurs.
- Apply to All Alarm out : Applies the configured schedule to all alarms.
 -  When the alarm is generated on the scheduled time, you can stop the alarm by canceling the schedule.

NETWORK CONFIGURATION

It provides networked monitoring of Live screen from a remote place, and supports mail forwarding function with events. You can configure the network environment which enables such functions.

Interface

You can set the network connection route and protocol.

Setting a network connection

Sets the protocol and environment of the network.

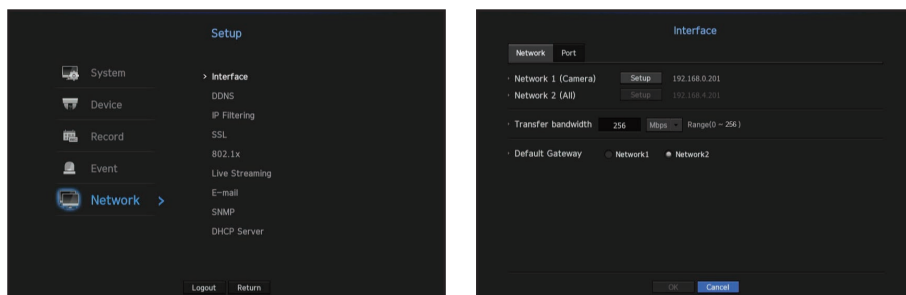

- Network 1 (Camera) : Port recommended for camera connection, which receives a image from the camera.
- Network 2 (All) : Port recommended for connection with a network, web viewer or iSCSI.
- Network 1 (Camera) / Network 2 (All) setup
 - IP Type : Select a network connection type.
 - IP Address, Subnet Mask, Gateway, DNS
 - <Static> : You can manually enter IP address, subnet mask, gateway and DNS.
 - <DHCP> : IP address, subnet mask and gateway values will be automatically set.
 - <PPPoE> : IP address, subnet mask and gateway values will be automatically set.
 - User ID, Password : If you set the connection mode to PPPoE, you need to enter "User ID" and "Password" to register in PPPoE.
 - In PnP mode, XRN-1610S Network 1 only set to DHCP.
 - We recommend not to set the same network address for Network 1 and Network 2.
- Transfer bandwidth : Enter the maximum amount of upload data bandwidth. Check the assigned setting in Connection Mode before entering your value.
 - If the sum of the network TX/RX is less than 256Mbps, there is a max transmission rate of 256Mbps.
- Default Gateway : Set the basic gateway by using Network1 / Network2 setup.



- You can manually input DNS of <DHCP> and <PPPoE> when it selected to <Manual>.

Connecting and Setting the Network

Networking may differ from the connection method, check your environment before setting the connection mode.

When no router is used

- **Static mode**
 - Internet connection : Static IP, leased line, and LAN environments allows connection between the NVR and remote user.
 - NVR Network Settings : Set the <Network> in <Interface> menu of the connected NVR to <Static>.
 - Consult your network manager for IP, Gateway and Subnet Mask.
- **DHCP mode**
 - Internet connection : Connect the NVR directly to a cable modem, DHCP ADSL modem or FTTH network.
 - NVR Network Settings : Set the <Network> in <Interface> menu of the connected NVR to <DHCP>.
- **PPPoE**
 - Internet connection : An PPPoE modem is directly connected to the NVR, where the PPPoE connection requires user ID and password.
 - NVR Network Settings : Set the <Network> in <Interface> menu of the connected NVR to <PPPoE>.
 - PPPoE <User ID> and <Password> should be the same to the PPPoE user information. If you don't know the ID and password, consult your PPPoE service provider.

When a router is used



- To avoid IP address conflict with the NVR's static IP, check followings :

• Setting the NVR with a static IP

- Internet connection : You can connect the NVR to a router which is connected to an PPPoE/Cable modem or a router in a Local Area Network (LAN) environment.

• Setting the NVR Network

1. Set the <Network> in <Interface> menu of the connected NVR to <Static>.
2. Check whether the set IP address is in the static IP range provided by the Broadband Router. IP Address, Gateway, and Subnet Mask : Consult your network manager.
 - Check whether the set IP address is in the static IP range provided by the Broadband Router.



- If a DHCP server is configured with starting address (192.168.0.100) and end address (192.168.0.200), you should set the IP address out of the configured DHCP range (192.168.0.2 ~ 192.168.0.99 and 192.168.0.201 ~ 192.168.0.254).

3. Check the Gateway address and subnet mask are equal to those set in the Broadband Router.

• Setting the DHCP IP Address of the Broadband Router

1. To access the Broadband Router's configurations, open a web browser on the local PC that is connected to the Broadband Router and enter the router's address (ex : http://192.168.1.1).
2. At this stage, make the local PC's windows network configurations to the below example :
 Ex) IP : 192.168.1.2
 Subnet Mask : 255.255.255.0
 Gateway : 192.168.1.1
 - Once connected to the Broadband Router, it prompts with password. While entering nothing to the User Name field, enter "admin" into the password field and press <OK> to access the router configurations.
 - Access the router's DHCP configuration menu and set its DHCP server activation, and provide the start and end address.
 Set the start address (192.168.0.100) and end address (192.168.0.200).

 Above steps may differ from the router devices depending on the manufacturer.

Port Setting

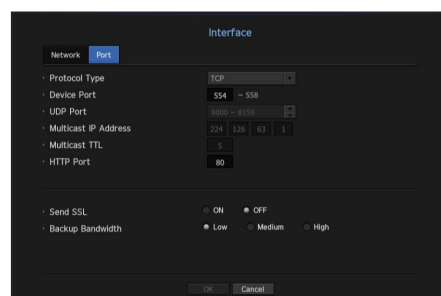

- Protocol Type : Select the protocol type among TCP, UDP - Unicast and UDP - Multicast.
- Device Port : Enter the connectable port number. Initially, <554> is set.
 - TCP : It has better stability and lower speed when compared to UDP, and recommended for internet environments.
- UDP Port : Initially, <8000~8159> is set. It increases / decreases by 160.
 - UDP : It has less stability and faster speed when compared to TCP, and recommended for local area network (LAN) environments.
- Multicast IP Address : User can directly input.
- Multicast TTL : Select from 0 ~ 255. Initial value for the TTL is set to <5>.
- HTTP Port : Enter the port number for the Web Viewer. Initially, it is set to <80>.
- Send SSL : Select this option to send SSL.
- Backup Bandwidth : Select the degree of backup bandwidth.

DDNS

If a remote user accesses the network, you can set whether or not to use DDNS and the site to be connected.

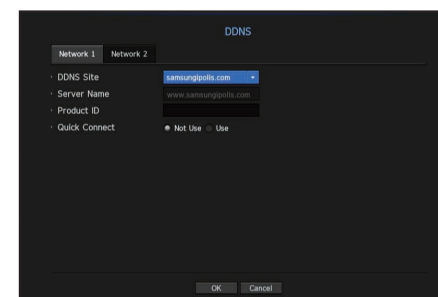

- DDNS Site : Specify the use of DDNS and select a site that you registered.
- Host Name : Provide the host name that you registered with the DDNS site.
- User Name : Provide the user ID that you registered with the DDNS Site.
- Password : Provide the password that you registered with the DDNS site.

-  Refer to "Using Virtual Keyboard". (Page 28)
- If you select <OFF>, the input box will be inactive.
 - If you select <iPOLiS>, the host name input box will be inactive. The user name input box will be active.

- Quick Connect : Appears if the <samsungipolis.com> is selected for a <DDNS Site>. To use the function, set to <Use> after connecting the NVR to a UPnP router.

-  If canceled during Quick Connect configuration, it automatically switches to <Not Use> and saved.

To check Quick Connect status

A progress bar and its message appears for a Quick Connect.

- **Quick Connect Success** : Message for a successful connection.
- **Invalid Network Configuration** : Message appears if the network configuration is not valid. Check the configuration.
- **Please enable UPnP function of the router** : Message appears if the router requires UPnP function enabled.
- **Failed to find the router** : Message appears if the router is not found. Check the router's configurations.
- **Please restart the router** : Message appears if the router should be restarted.

DDNS Setting

DDNS is a short form of Dynamic Domain Naming System.

DNS (Domain Name System) is a service that routes a domain name consisting of user friendly characters (ex : www.google.com) to an IP address consisting of numbers (64.233.189.104).

DDNS (Dynamic DNS) is a service that registers a domain name and the floating IP address with the DDNS server so that the domain name can be routed to the IP address even if the IP is changed in a dynamic IP system.

• Setting DDNS in the NVR

Set **<Protocol Type>** in the **<Protocol>** menu of the connected NVR to the following :

Ex) Protocol Type : TCP
 Port (TCP) : 554, 555, 556, 557, 558
 DDNS Site : iPOLiS

• DDNS Settings of the Router

Select the corresponding menu for the network transfer protocol of the router.

• Setting up UPnP of Router

Refer to the router's documentation to enable the UPnP function of the router.

IP Filtering

You can prepare the list of IP addresses to allow or block access to a specific IP address.

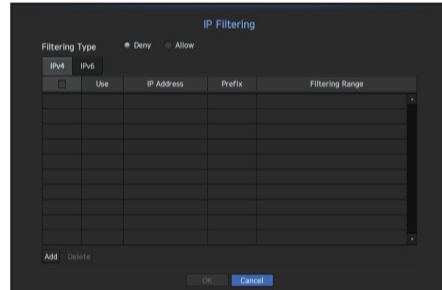

• Filtering Type :

- Deny : If you select reject, access to the registered IP address will be limited.
- Allow : If you choose permit, then they can only access the registered IP addresses.

• Use :

Select the checkbox for the IP address that will use IP filtering.

• IP Address :

Enter the IP address for filtering.

• Filtering Range :

If you enter an IP address or prefix, then the range of IP addresses blocked or permitted will be displayed.

! If a camera's IP address is not included in the Permit list or is in the Reject list access to it will be rejected.

SSL

You can select a security connection system or install public certificates.

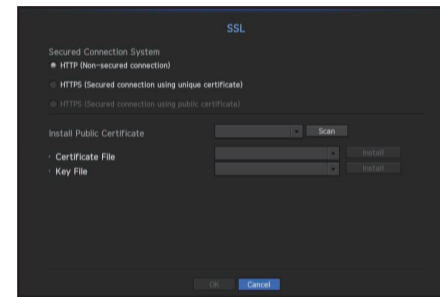

• Secured Connection System :

- HTTP (Non-secured connection)
- HTTPS (Secured connection using unique certificate)
- HTTPS (Secured connection using public certificate)



If the NVR device is connected to the external internet or installed in an environment with high priority for security, making a secure connection is recommended.

• Install Public Certificate :

You can scan and register public certificates to be installed. If you want to use a certificate, you need to install a certificate file along with an encryption file.

- The **<HTTPS (Secured connection using public certificate)>** menu can be selected only if there is a registered public certificate.

802.1x

When connecting to a network, you can select whether to use the 802.1x protocol and install a corresponding certificate.

802.1x is a certificate system for the server and the client. It can guarantee robust performance against hacking into the Tx/Rx network data, virus or information leaks.

By using this system, you can block access from a client who is not certified and only allow communication to certified users and thus increase the level of security.

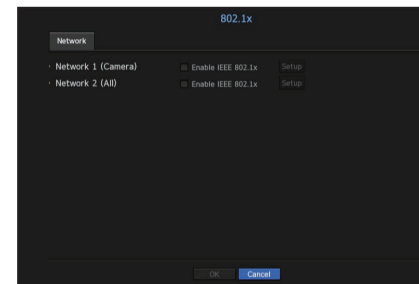

In PnP mode, XRN-1610S can't setup the Network 1.

• EAPOL Version :

- Select the EAPOL version to be used as protocol.
- Some switch hubs will not operate if you set them to version **<2>**. Select version **<1>**.

• ID :

- Enter the ID provided by the RADIUS server administrator.
- If the entered ID does not match the ID of the client's certificate, it won't be processed properly.

menu setup

- Password : Enter the password provided by the RADIUS server administrator.
 - If the password you entered does not match that of the client's private key, it won't be processed properly.
- Certificates : Search for a device. Click on <Rescan> to search for a device again.
- CA Certificate : Select this only if your public certificate includes the public key.
- Client Certificate : Select if the public certificate includes a client's authentication key.
- Client Private Key : Select it if the public certificate contains the client private key.

- For successful implementation of the 802.1x operating environment, the administrator must use the RADIUS server. In addition, the switch hub connected to the server must be a device that supports 802.1x.
 - If the time setting of the RADIUS server, the switch hub and an NVR device do not match, communication between them can fail.
 - If a password is assigned to the client's private key, the server administrator should confirm the ID and password. The ID and password allow up to 30 characters each. (But it only supports letters, numbers and special characters ("-", "_", ". " 3 types) only. Accessing non password-protected files is allowed without entering a password.
 - The 802.1x protocol adopted by the NVR is EAP-TLS.
 - You need to install all three certificates to use 802.1x.

Live Streaming Setting

You can set the video profile transmitted to the network and the expansion monitor.

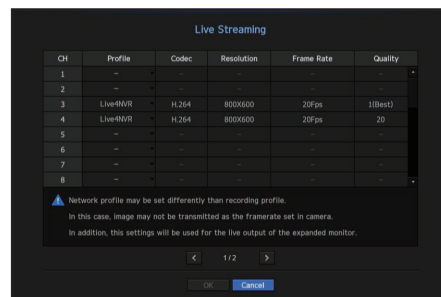

- Profile : Select a network profile for the connected camera.
- Codec : Show the codec information for the selected network profile.
- Resolution : Display the resolution for the selected network profile.
- Frame Rate : Display the frame rate for the selected network profile.
- Quality : Display the video quality for the selected network profile.

- If the profiles used for network and recording are different, camera's video feed may not comply with the frame rate as specified in the camera.

E-mail

You can send an e-mail to a NVR-registered user at a specific time interval, or if an event occurs.

SMTP Setting

Sets the SMTP mail server.

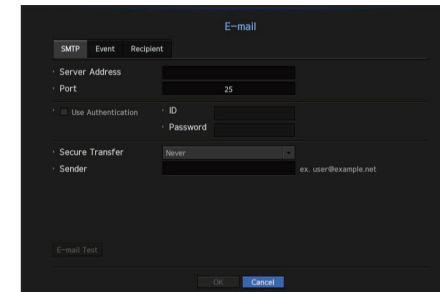

- Server Address : Enter the SMTP server address to connect to.
- Port : Sets the communication port.
- Use Authentication : Check this if the SMTP server uses user authentication. The account input box will be activated.
- ID : Enter a ID to use authentication when connecting to the SMTP server.
- Password : Enter the password of the SMTP server user.
- Secure Transfer : Select one from <Never> and <TLS (if available)>.
- Sender : Use the virtual keyboard to enter the sender's e-mail address.
 - Refer to "Using Virtual Keyboard". (Page 28)
- E-mail Test : Conducts the test on the server settings.

Event Setting

You can set the interval and type of the event that will be sent to the user.

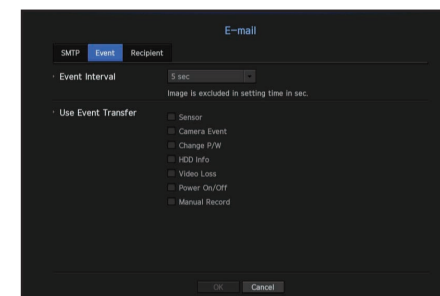

- Event Interval : Set the event interval.
 - If a series of events occurs, the e-mail will be sent at the specified interval, not on each event.
- Use Event Transfer : Select an event type to send if an event occurs. If the selected event occurs, the e-mail will be sent to the group that has the recipient authority.

Recipient Setting

You can create a group and add users to it or you can delete users and change a group.

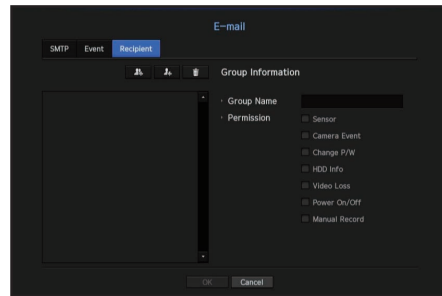

- Click on <Add> to add a group. Select a group name and the privilege.
- Select a recipient group to receive emails. If a group is added, it will appear in the group list.
- Click on <Add> to add a recipient. Select a group and enter names and email addresses. If a group is created, you can add a recipient.
 - For inputting the recipient name and email address, refer to "Using Virtual Keyboard". (Page 28)

SNMP

Using the SNMP protocol, the system or network administrator can monitor the network devices remotely as well as the operating environment.

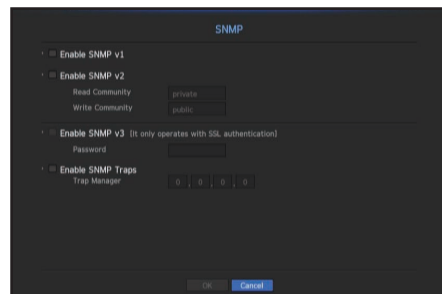

- Enable SNMP v1 : SNMP version 1 is used.
- Enable SNMP v2 : SNMP version 2 is used.
 - Read Community : Enter the name of read-only community to access the SNMP information. By default it is set to <public>.
 - Write Community : Enter the name of write-only community to access the SNMP information. By default, it is set to <private>.
- Enable SNMP v3 : SNMP version 3 is used.
 - Password : Set the initial user password for SNMP version 3.
- Enable SNMP Traps : SNMP trap is used to send important events and conditions to the Admin System.
 - Trap Manager : Enter the IP address to which messages will be sent.

! ■ SNMP v3 can be set only if the security connection method is set to HTTPS mode. Refer to "SSL" for more details. (Page 47)

DHCP Server

You can set the internal DHCP server and assign an IP address to the network camera.

Network Setting

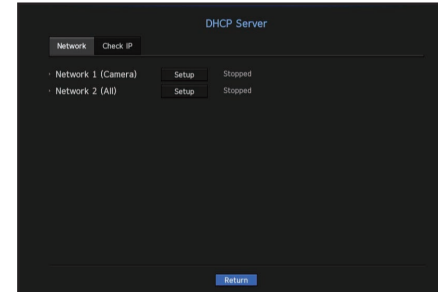

- Network 1/2 : Select <Setup>, and you can set the IP range operated by the server and time. In PnP mode, XRN-1610S only Network 1 supports DHCP Server.

To set the DHCP server

1. On the DHCP Server Setup window, click <Setup>.
2. Select <Run> in the <Status> field.
3. Enter the starting IP and end IP in the <IP Range> field.
4. Fill in the <IP Lease Time> field.
5. Click <OK>. The IP range entered is set as the DHCP server address of the network.

Check IP

You can check the IP Address and Mac currently used through the DHCP server, and the connected network port.

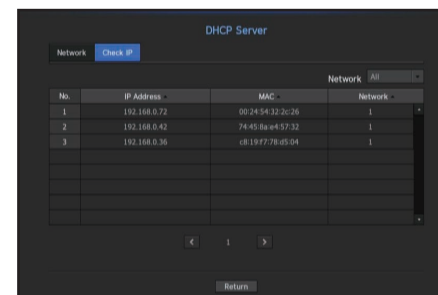

- Network : Select the network port to check the information on IP and others.



- For a Standby device, you can only use limited functions in the <System Environment>, <Device> and <Network>

search & play

SEARCH

You can perform the search for recorded data by the time or by the search criteria such as an event. You can access the <Search> menu directly in Live mode.

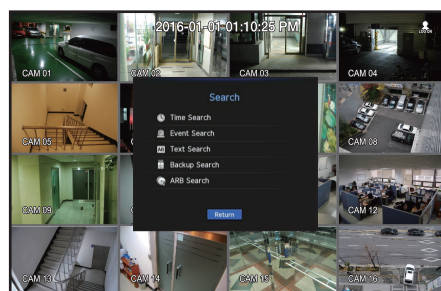

1. In live mode, right click with your mouse button. The Live menu appears.
2. Select <Search>.
3. The Search menu should appear.
4. The search can be restricted by the Auto Delete function. Refer to "**Setting the Recording > Record Option**". (Page 42)

- Overlapped data : It only appears if there exists overlapped data on a certain time, produced due to the change of NVR's time setup. The latest data comes first, from <List0>. It does not appear in <Backup Search>.
- The search time is based on the time specified by NVR.

Time Search

You can search for recorded data of a desired time. The displayed time is based on the local time zone and the daylight saving time (DST). Therefore, data recorded at the same time from different areas may differ based on the time zone and the DST.

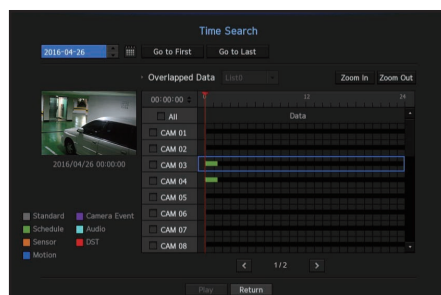

1. Select <Time Search> in the <Search> menu.
2. In the date selection window, click on the < > button to select a search date.
 - For using the calendar, refer to "**To use the calendar**". (Page 27)

3. The record data on the specific date will be listed. The display bar is different according to the data type. So check the data type for the color in the left pane.

- If DST (Daylight Saving Time) is configured, overlapping multiple recordings may be produced for a certain moment of time. Such a time section is distinguished with red color to mark DST section.

- Go to First : Move to the earliest recording date.
 - Go to Last : Move to the latest recording date.
 - Time : Enter a time to perform the search or use the up/down button < > to select one.
 - Zoom In : The map enlarges in detail. It will switch in the sequence of 24hours - 12 hours - 6 hours - 2hours - 1 hour.
 - Zoom Out : The map will switch in the reverse order of the detailed mode above. It will switch in the sequence of 1hour - 2 hours - 6 hours - 12 hours - 24 hours.
 - Preview : Click <Channel> and select (click, drag) a time in <Duration> to display a still image for the portion.
 - If the selected channel does not contain any recorded data, it will be marked black.
4. Select a data item and click <Play>. The screen switches to the data playback mode.

Color indications depending on current recording status

The recorded data types are represented through the use of different colors. Each color corresponds to a certain recording type.

Event Search

You can search for events by the channel and play them.

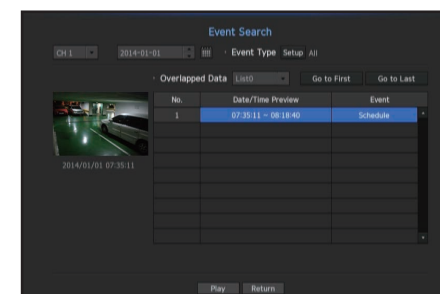

1. Select <Event Search> in the <Search> menu.
 2. Configure the channel, search date and event type settings.
 - Depending on the menu selected, it will search for all/motion detection/video analysis/defocus detection/audio detection/sensor/schedule/standard recording events.
 - Date/Time Preview : If you select a data item in the list, the still image of the selected data will be displayed in the left preview pane.
 - Event : Displays the type of the event that occurred.
3. Select a data item and click <Play>. The screen switches to the event data playback mode.

Text Search

You can search data that was entered into POS systems connected to NVR.

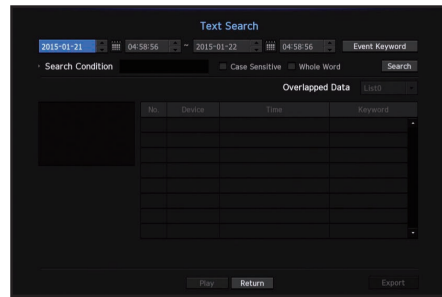

1. Select **<Text Search>** from the **<Search>** menu.
2. Please specify the search criteria and click the **[Search]** button.
 - A deeper and more detailed search can be performed by using specific characters.
- Search characters : Enter characters using a virtual keyboard.
- Event Keyword : Search using a condition set in the "Device > Text > Event settings" menu. (Page 41)
- Search Condition : Enter a word to search in the input screen and press the **<Search>** button.
 - **<Case Sensitive>** : If this option is checked, the search terms are case-sensitive.
 - **<Whole Word>** : If checked, only results that exactly match the input words will be displayed.
- Time overlap : This is displayed if there is data duplicated during a preset time interval.
- Preview screen : If data is selected from a list, a preview image is displayed. All information is displayed in the text display below.
- Export : Stores all text search information recored in NVR to storage media.
3. Select data and **<Play>**.
 - Moves to a replay screen for searched text data.

Backup Search

Searches for backup data in the connected backup device. Only data in the format of NVR is included in the search.

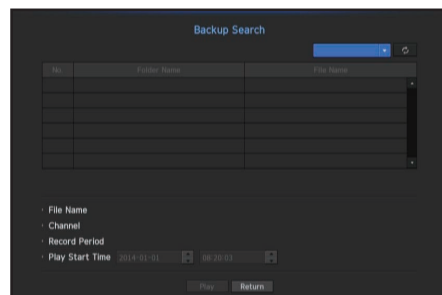

1. Select **<Backup Search>** in the **<Search>** menu.
2. When storage media with data is connected, the list of recordings stored is displayed on the equipment.
 - File Name : Displays the name of a file recorded.
 - Channel : Displays the recorded channel.
 - Record Period : Displays the record period.
 - Play Start Time : Select a time that you start playing.
3. Select data to play and click **<Play>**.
 - The screen switches to the backup data playback mode.

ARB Search

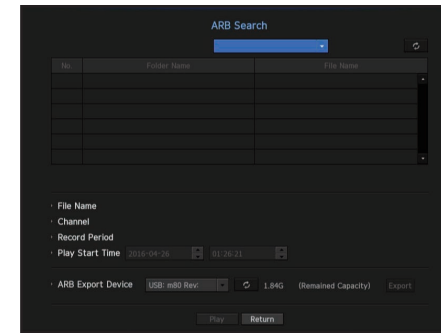

1. Select **<ARB Search>** from the **<Search>** menu.
2. The type and model name of the ARB storage device are displayed. When storage media with data is connected, the list of recordings stored and ARB data volume are displayed on the equipment.
 - File Name : Displays the name of a file recorded.
 - Channel : Displays the channel recorded.
 - Record Period : Displays the duration of recording.
 - Play Start Time : Select the time at which the video is to be played.
 - ARB Export Device : Selects an ARB storage device and exports a file.
 - Press the **[]** button and you can check the free space remaining in the storage device.
3. Select data to play and click **<Play>**.
 - The screen moves to the ARB backup data play screen.

PLAYBACK

Play

You can play data stored in the HDD and backup a desired portion of the data.

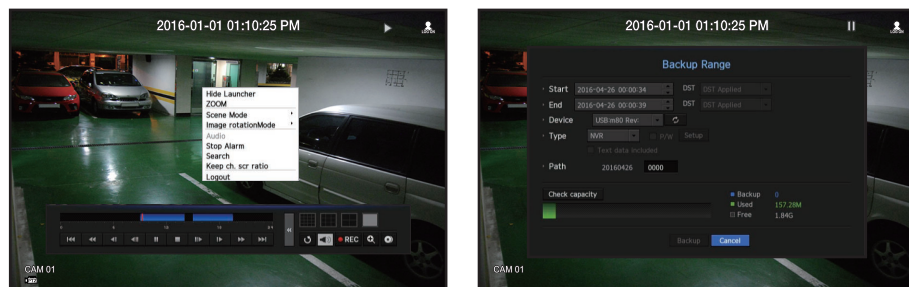

1. In the live screen menu, select the <Play> menu or click on <▶> in the launcher menu.
 2. Select a menu for searches.
 - If this is the first time you try to play, you will start with the data search window. For data search, refer to "Search". (Page 50)
 3. Select a data item and click <Play> in the Search menu. The selected data is played and the play launcher appears on the screen.
 - If there is an existing data, <Play> will start immediately without performing the search.
- Playback Information : Displays the date and time of the current data in the top corner.
 - Backup : Click <🕒> to set the current time to the start time of backup; you can specify a backup area using the mouse (yellow triangle). Click <🕒> again to set the current time to the end time of the backup and the "Backup Range" window appears.
 - Type : Supports formats of NVR and SEC.
 - When you select the SEC format, you can select or deselect "Text data included".
 - Device : Select a backup device.
 - Check Capacity : Enables you to check the capacity of the selected storage device.
 - 4. If you want to go back to the live screen during plays, then click on <■> of the launcher menu.

Checking menu while playing a video

1. Right-click on the play screen. Screen menu appears on the play screen.
2. Select a menu to run. For more information about each menu, please refer to the "Split Mode Menu". (Page 18)
 - Rotate mode only appears in single screen mode. You can rotate the play screen by 90 degrees.

Using the Playback Button

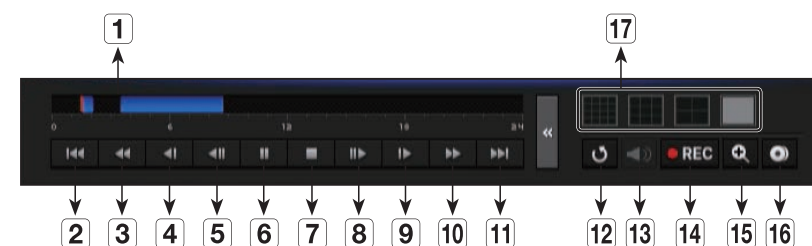

Name	Description
1 Play Timeline	Indicates the current playback point, and can be used to move.
2 Skip Backward	Moves backward by unit time.
3 Backward Fast Play	Used for quick backward search while in Play.
4 Backward Slow Play	Used for backward frame-by-frame search while in PAUSE.
5 Step Backward	Moves backward by one frame at a time.
6 Pause	Stops playing the current video temporarily.
7 Stop	Stops playback and moves to the live screen.
8 Step Forward	Moves forward by one frame at a time.
9 Forward Slow Play	In a split mode, the real time playback may not be supported, depending on the record quality, resolution and number of channels. And some frame rates may be supported.
10 Forward Fast Play	Used for quick forward playback.
11 Skip Forward	Moves forward by unit time.
12 Return	Return to the search setup screen.
13 Audio	Sets Audio ON/OFF.
14 REC	Records all channels in Live mode.
15 ZOOM	This is available in Single mode, which will enlarge the video from a selected channel. To cancel the zooming, simply double-click the enlarged image or select <Close Zoom> in the Live screen menu.
16 Partial Backup	Begins backup of the selected section of the video being played, with the specified starting/ending point.
17 Mode Switch	Click on a desirable play mode to change the screen segmentation mode.

WHAT IS WEB VIEWER?

WebViewer is a software program with which the operator can access a remote NVR (Network Video Recorder) for real-time monitoring, PTZ control (if configured) or search.

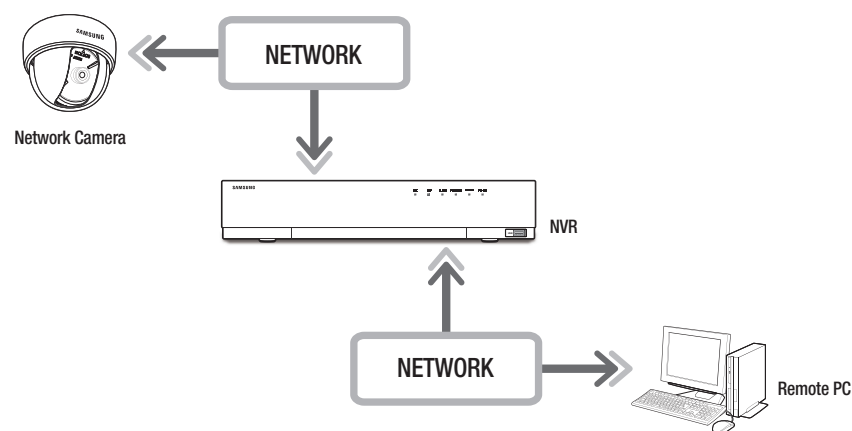

Product Features

- Remote connection using the browser
- PTZ camera control enabled
- 4:3 mode : supports 1 / 4 / 9 / 16 / 1+5 / 1+7 / 1+12 / 1+9 / 1+11 / 2+8 channels (up to 16 cameras)
- 16:9 mode : supports 6 / 12 / 20 channels (up to 16 cameras)
- Saving function in JPEG/BMP/PNG image format for printing and storage.
- Record video in AVI format-compatible with popular media players. (The integrated codec is needed)
- To play the video in Windows Media Player, you must download and install the relevant codec from www.windows7codecs.com. (version 4.0.3 or higher)

System Requirements

The following lists the minimum suggested hardware and operating system requirements needed to run the Web Viewer.

Item	Minimum	Recommended
CPU	Intel Core 2 Quad 2.5GHz or higher	Intel i7 (3.5GHz) or more
RAM	3GB or more	4GB or more
HDD	200GB or more	500GB or more
VGA Memory	512MB or more	1GB or more
Display Resolution	1280 x 1024 or higher	
OS	- Supported OS : Windows 7, 8.1, 10, Mac OS X 10.9, 10.10, 10.11 - Plug-in free web viewer Supported web browsers : Google Chrome 47, MS Edge 20 - Plug-in Webviewer Supported web browsers : MS Explorer 11, Mozilla Firefox 43, Apple Safari 9 ※ Mac OS X only	
Network	10/100/1000 Ethernet NIC	

CONNECTING WEB VIEWER

1. Open your web browser and type the IP address or URL of NVR into the URL address box.

- Accesses the web viewer by connecting to Network 2 (recommended).
- "192.168.2.200" is set to IP by default.
- You must have specified the IP address in "Network > Interface".
- The URL connection will be enabled only when the DDNS connection settings have been completed. For more information, refer to "Network Configuration > DDNS". (Page 46)

2. A user with the admin permissions should provide the admin ID and password. A registered user should provide the user ID and password.

- The initial ID and password for webviewer is "admin" and "4321". When an initial password is entered, while partially resetting to access a web viewer, a pop up window will appear that will guide the user to change the password and when doing a whole reset to access a web viewer, a pop up window will appear that will guide the user to complete the settings for the Install Wizard. Set a new password when a pop up window appears.
- Please change your password every three months to safely protect personal information and to prevent the damage of the information theft. Please, take note that it's a user's responsibility for the security and any other problems caused by mismanaging a password.



- It allows up to 10 simultaneous access including the Admin and general users.
- Password of the Admin and general users can be changed in <User> menu of the NVR.
- Normal users should have set <Webviewer> under <Restriction on Network Access> to Use before connecting to the Web Viewer. (Page 27)
- All settings are applied by the NVR's settings.

3. The plugin installation confirmation pop-up window will appear.

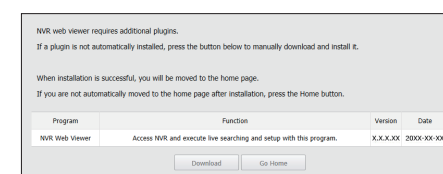

4. When a program installation wizard window appears, press the [Install] button to install the program.
 - The version of the program installed may vary depending on the update version.

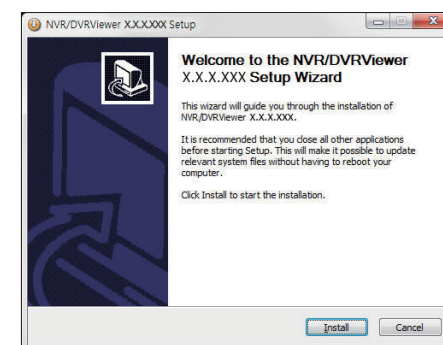

5. When program installation is complete, click on the [Finish] button.
6. After completing installation and successfully logging in, the main live viewer screen appears.

starting web viewer

If you want to access the web viewer with multiple browsers

Set auto execution of plugin (npNVRViewer) in the browser menu that you first access and refresh the screen after activating the plugin or selecting plugin reliability.

- Each time the browser is upgraded in the future, the plugin activation method can be changed. Plug in setting menu can be referred to in the browser manual.

- For chrome browsers, "**Plug in is not activated. Please select 'Always run on this site' and refresh**", then select the '**always execute on this site**' button in the top of the browser.

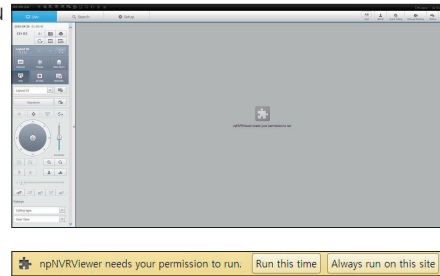

- On a browser in the latest version that does not support plug-ins, please refer to the descriptions about the plug-in free web viewer stated below.

Accessing the Plug-in Free Webviewer from a web browser

To log in

- Open a web browser and enter the IP address of the NVR or a URL in the address bar.
- A user with administrator authority should enter an administrator ID and password. A regular user should enter a user ID and password.
- <Lite ver. Webviewer> check box is selected by default on a browser that does not support plug-ins.
 - This option is only supported by an Internet browser that does not use plug-ins (e.g. Chrome, Edge Browser)



< Chrome, Edge Browser >



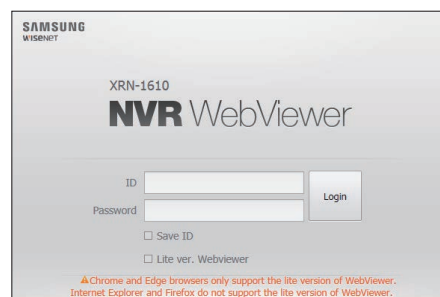

- As the plug-in free webviewer has lower performance than the plug-in webviewer, it has a limit on the monitoring of high quality profiles. To monitor high quality profiles, use either a plug-in webviewer or network Viewer.

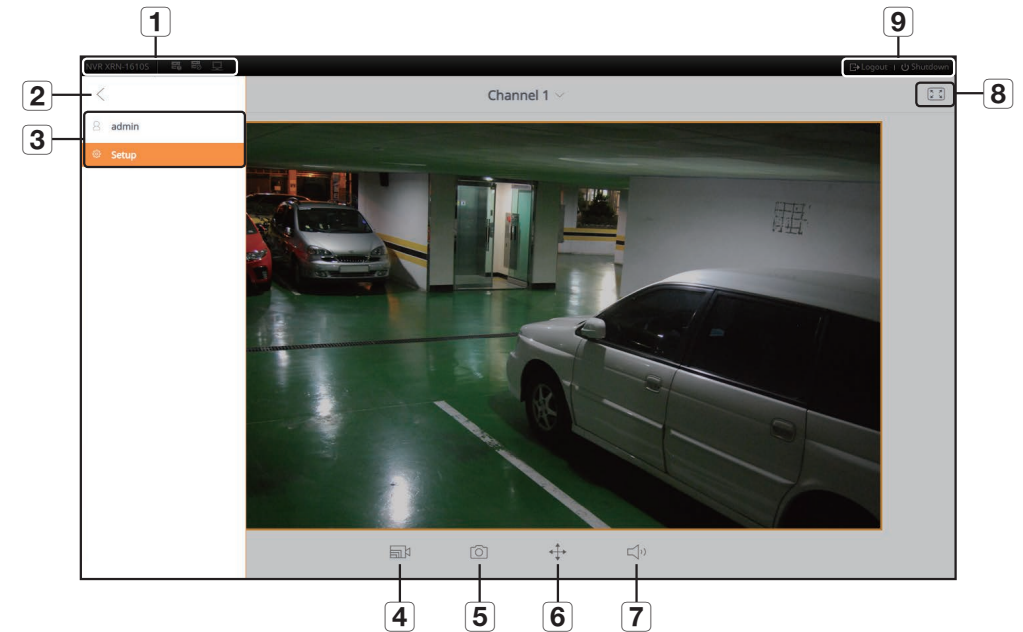

< Internet Explorer >

Live viewer screen layout



Menu	Description
1	System Status Display Displays icons that indicate the screen state of system status. <ul style="list-style-type: none"> For more information about each icon, please refer to "System Status". (Page 56)
2	View Menu Enables or disables View Menu.
3	Select Menu Displays the user login ID and moves to the setup page. <ul style="list-style-type: none"> The way that you configure settings is identical to the existing web viewer settings. Please refer to <Setup Viewer>. (Page 64)
4	 Changes the camera profile.
5	 Captures the current video and saves it in a designated path.
6	 Supports the PTZ Digital Zoom function.
7	 Turns the sound ON/OFF.
8	 Changes the aspect ratio.
9	Logout Logs out your account.
	Shutdown Turns off the power of the NVR system.

- Plug-in Free Webviewer only supports a single split live screen.
- You can change the live screen by selecting <Channel 1>.

LIVE VIEWER

You can check the video from camera registered in the NVR connected from a remote PC. Also, you can adjust the camera and check the network transfer status.

Live Viewer Screen



Menu	Description	
1 System Status Indicator	Displays icons to display the screen or system status.	
2 Menu Selection	Switches into corresponding menu screen by clicking each menu.	
3	Date/channel	Shows the access date/time and the selected channel.
	Audio	Sets the sound connected to each channel to either ON/OFF.
	Capture	Saves current video for the selected channel in the path designated by the user.
	Print	Prints current video image for the selected channel through designated printer.
	Image Rotation	Rotates the screen of a selected channel by 90 degrees.
	Keep ch. scr ratio	Changes screen ratio of the selected channel.
	Keep full scr ratio	Changes screen ratio for all channels.
4	Channel change	Switches to the previous/next channel group.
	Full screen	Switch from the full screen to the split screen. Press the [ESC] key on the keyboard to exit full screen mode. <ul style="list-style-type: none"> Safari for Mac does not support full screen mode.

Menu	Description	
Channel information	Shows the channel information selected. <ul style="list-style-type: none"> If the user's PC monitor does not support 60Hz at a specific high resolution, or the HDMI cable does not support HDMI 2.0, 60fps or higher will not be output from the channel information. 	
Freeze	Temporarily stops the videos in all the channels or deactivates the Pause function in suspending status.	
5 Stop Alarm	Deactivates an alarm when it occurs.	
OSD	Check the OSD item to display the OSD screen information in the web viewer window.	
PC recording	Saves the real-time video, in AVI format, from the selected channel in a designated folder on the PC.	
NVR recording	Start and stop NVR recording.	
6 Layout setting	Set the layout.	
7 Sequence Setup	Set the sequence.	
8 PTZ	Controls connect PTZ camera(s).	
9 Fisheye	Runs the fisheye settings for the selected channel. (Configures the mounting mode and the view mode to correct the screen distortion.)	
10 Display Pane	Text	Turns text devices and data output located in the right side of Search ON/OFF.
	ID	Display the ID of user connected.
	Quick setup	Simple camera registration and recording settings.
	Manual backup	Manually backup the video of the camera connected.
	Status	Shows the camera live and recording status.
	Help	Move to the help window.
12	Logout	Performs logout process.
	Shutdown	Turn off the NVR system.

LIVE SCREEN CONFIGURATION

System Status

You can check the status or operation of the NVR with the icons on the live screen.

- On a plug-in free web viewer, the status information icon is not displayed.



Item	Description
System Operation	It is displayed when there is a problem with the fan.
	It is displayed when there is an issue with the recording conditions.
	Displayed if the HDD is full and the NVR has an insufficient space to record.
	Displayed if no HDD is installed or the existing HDD should be replaced.
	Displayed if the HDD needs a technical examination.
	It is displayed when the max permitted amount of data for each channel is exceeded.
System Operation	It is displayed when an iSCSI device is disconnected.
	It is displayed when the network is overloaded. It is displayed when the network is overloaded. <ul style="list-style-type: none"> It occurs when the max receiving performance is exceeded, causing an overload to the CPU. It will disappear if you modify the camera setting or delete a camera to reduce the level of performance overload.
	It is displayed when there is firmware to update the server. It is displayed when there is firmware to update the server.
	It is displayed if the battery level for an NVR device is empty.
	If you press the screen stop button, it is displayed.
	It is displayed when all the channels are switched at the set time interval.

To capture a screen

- Click < > button.
When a pop-up window appears, select the saving path for captured image.
 - Select the path and name the file. And then click the [OK] button.
 - Save current camera's video image as .bmp, .jpg or .png file.
- ! If the viewer is running without the administrator's permission in Windows 7, you may not save the captured image as .bmp, .jpg or .png file.

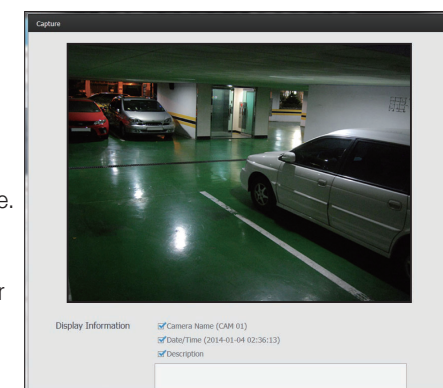

To print a screen

- Click < > button.
- Print current camera's video image with the printer connected to the PC operating the Web Viewer.

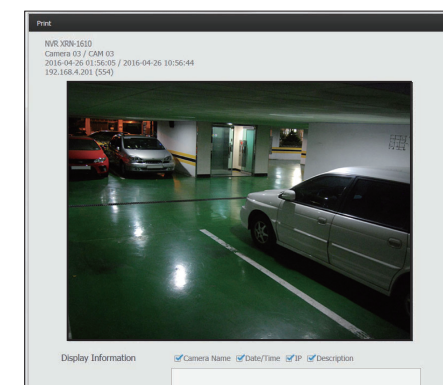

Setting the layout

If you don't add or save it in the layout after registering a camera, the live screen will not be displayed.

Click on the  > button to launch the layout setting screen.

If you want to add a layout

Click on  >.

Set the layout name to add and click on the <OK> button to add it.

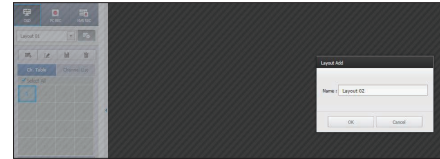

If you want to change the layout name

Select the layout name to change and click on  >.

After changing the name, click on the outside of the layout window to change the name.

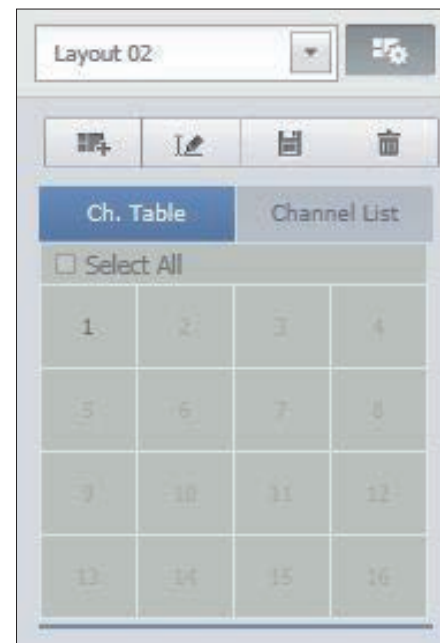

If you want to save the layout

Click on  >.

The changed layout will be saved.

 ■ The layout for each user is saved separately.

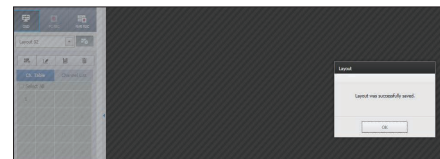

If you want to delete the layout

After selecting the layout to delete, click on  >.
The selected layout will be deleted.

 ■ Unless you press the Save or Delete button, changes will not be saved.



Changing Split Mode

When clicking the Split Mode selection button, the screen is changed into the selected split mode.



Setting screen switching

If you don't register the layout, the screen switching function will not operate.

You can view the layouts one by one.

Click on the  button to launch the switching setting window.

1. Select the layouts to be shown in turn by pressing .
2. Enter the screen switching time.

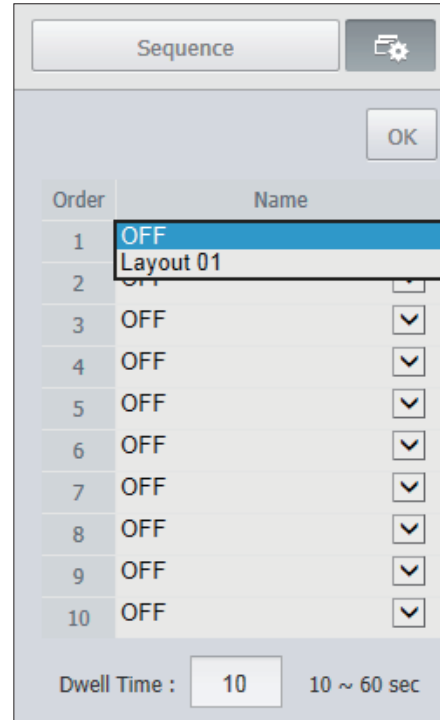

3. Click on the **<OK>** button to save the designated sequence.

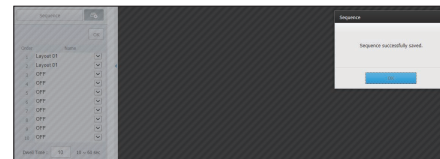

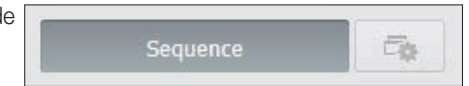

To perform switching

Click on the **<Sequence>** button to activate the switching mode and run a sequence.

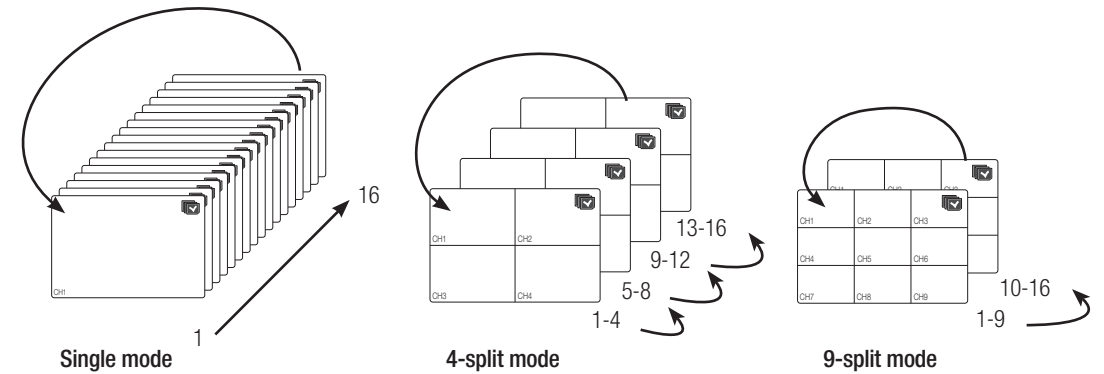

Auto Sequence



-  In a split mode, If you have set **<Sequence switching time>** in "Device > Monitor", Auto Sequence will be conducted at the set interval. (Page 40)
- When switching to another channel, the video may be slightly delayed depending on network status.
- If you perform automatic switching of a single screen, the layout setting menu will be deactivated during operation.

How to query text devices and data

Checks the text data transmitted from POS systems that are connected to NVR.

If the  button is selected, you can turn on/off the function to query text devices and data located in a separate area.

- A queried device should be set in terms of its usage, channel, etc. by selecting "Device > Text > Device". (Page 40)

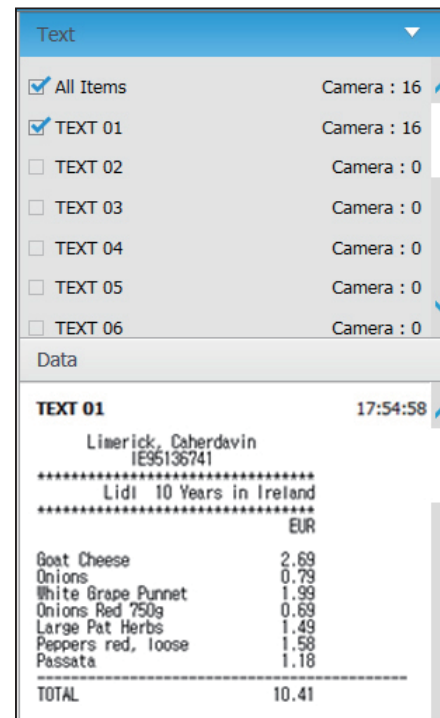

CONTROLLING A CONNECTED NETWORK CAMERA

Controlling PTZ



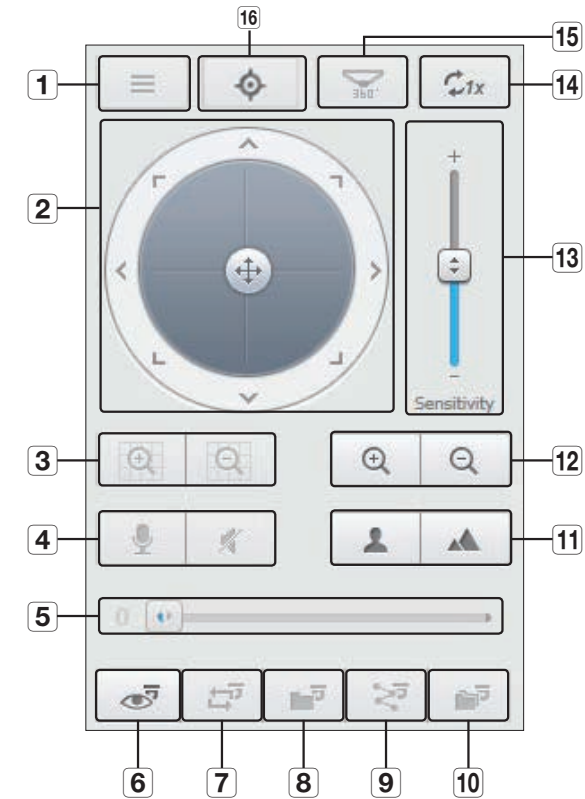

If PTZ camera is connected, the  icon appears on screen. When selecting corresponding camera channel, the PTZ tab is provided to allow you to control the PTZ.



Item	Description
1 Camera menu	Displays the camera settings menu.
2 Direction Adjustment	Use this to adjust the direction of the camera or click the crosshair in the center to use it as an OK button.
3 Digital zoom	Adjust digital zooming to make an image larger or smaller.
4 Sound	You can set the camera audio talk and mute.
5 Volume control	Change the PC volume between 0 and 100.
6 Preset	Sets the preset position for camera framing and moves to designated preset position when selecting a desired preset.
7 Swing	Moves between the preset start point and end point.

Item	Description
8 Group	Moves in the path specified by combining the preset.
9 Trace	Moves camera's framing in the predefined path.
10 Tour	Moves in the path specified by combining multiple groups.
11 Focus	Adjusts the focus of the camera.
12 Zoom	Zooms in/out the image by controlling camera's zoom.
13 Sensitivity	Adjust the sensitivity of your camera operation.
14 Digital Zoom Off	Returns to the original size from the zoomed state.
15 Fisheye D-PTZ	Provides the digital PTZ function for the distortion corrected screen.
16 Simple Focus	Focus by controlling camera's simple focus

To activate digital zoom

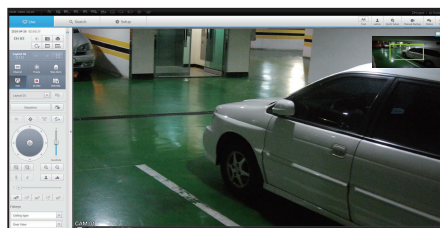

1. Press the  button and the screen will be zoomed in by 50% per click.
 2. Press the  button and the screen will be zoomed out by 50% per click.
 - You can zoom in or out by 10% with the mouse wheel.
 3. Click the  button and the screen returns to 100% size.
-  ▪ Digital zoom function is only available in the single model.



To use the digital PTZ function on a distortion corrected screen

1. Click the icon on the distortion corrected screen.
2. Mouse over the screen and drag to control.

To set a preset

1. Click <  > button to display "Preset" window.
2. Click on <  > to select the preset order.
3. Enter the name of preset.
4. Use direction keys to adjust the direction which camera aims at.
5. Click the <  > button.

To activate the preset

1. Click <  > button to display "Preset" window.
2. Select a desired preset to activate from the list. The camera's framing moves to the preset position.

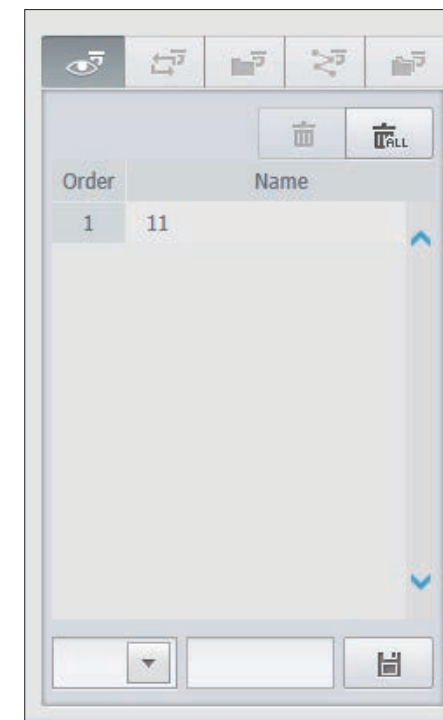

To activate Swing(Auto-pan), Group(Scan), Trace(Pattern) and Tour

You can activate listed functions in the same manner as using a preset. For more information, refer to corresponding user manual of applicable camera.

-  ▪ Only selective functions of the camera can be supported, depending on camera.

To use the Digital PTZ (D-PTZ) function

1. Register a camera that supports the D-PTZ profile.
 - In cameras that support the D-PTZ profile, you can use the D-PTZ function.
2. Both cameras that support general PTZ and cameras that support D-PTZ can control the live image using some of the <PTZ control> function menus.
 - For more information about the supported functions, please refer to the camera manual.

SEARCH VIEWER

You can search and play the video record saved in NVR by accessing NVR remotely.

Search Viewer Screen

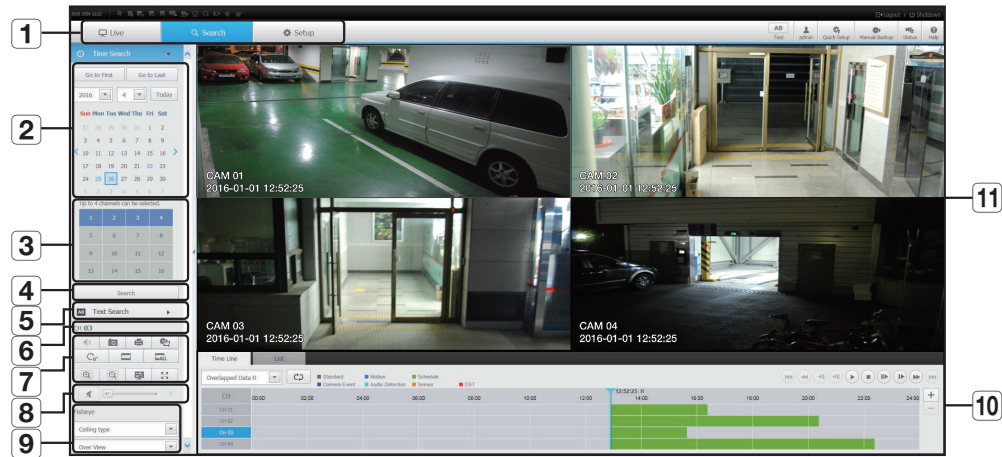

Item	Description
1	Menu Selection Switches to the corresponding menu screen by clicking each menu.
2	Calendar Displays the video-recorded date in blue. Click the date in blue color to display the recorded video information in timeline.
3	Channel selection Displays the search channels.
4	Search Search for the user designated channel for the selected date.
5	Text Search Searches data that was entered into POS systems connected to NVR.
6	Channel displays Display the selected channel number.

Item	Description
	Audio Sets the sound connected to each channel to either ON/OFF.
	Capture Saves current video for selected channel in the designated path.
	Print Prints current video image for selected channel through the assigned printer.
	Section backup Backup the video for the selected section.
7	Image rotation Rotates the screen of a selected channel by 90 degrees.
	Keep ch. scr ratio Changes screen ratio of the selected channel.
	Keep full scr ratio Changes screen ratio for all channels.
	Digital Zoom In/Out Zoom in or zoom out the current video for the selected channel.
	OSD Displays the channel information.
	Full screen Show the four way split screen in the full screen.
8	Sound control Adjust the audio for the video searched.
9	Fisheye Runs the fisheye settings for the selected channel. (Configures the mounting mode and the view mode to correct the screen distortion.)
10	Recording Color Displays the corresponding color depending on recorded data type if you place your mouse cursor on that area.
11	Display Pane Plays corresponding data on the screen if you select a search result.

Time Search

You can search recorded data by setting date and time.

To search by date

You can select the search date by using calendar.

- Click on < < > > to select the year/month for your search.
If a date has data associated with it, it is displayed in blue. The current date is displayed as a blue box.
- Click the date to search in calendar.
The first image of searched video data on the date is displayed on screen and the data is displayed in the timeline.
- To search video data on today, click <Today>.
Today's date is selected.

Color indications depending on current recording status

Displays the corresponding color according to the recorded data type.



- If 2 or more kinds of recording type are mixed for the same timeline, only the recording type with higher priority is displayed. (Priority: Standard > Motion > Schedule > Sensor > Camera Event > Audio Detection > DST)

To adjust timeline

If searched data are overlapping, you can select a desired data, move its playback time point, and zoom in/out the timeline.



- Select the number of data to search if data is overlapping. It appears only when data are overlapped and assigns <0> to the most recent data.
- Click your desired time point to play on the timeline. The playback start point is moved.
- Click <+> / <-> to zoom in/out the zoom factor to display time.
- When magnified, if you want to view the pre/post timeline, click on the timeline and drag it in the direction you want to move it.

If you want to check the recording list

The results for each recording section will be displayed.

No.	Ch	Start Time	End Time	Event Type	DST Type
1	1	01:41:04	01:41:04	Schedule	
2	1	01:49:42	03:23:36	Schedule	
3	3	01:49:52	03:23:51	Schedule	

To back up the search results

You can back up the search results in the list.

- Click the [] button.
- From the search results, select the check box of the item you wish to back up.
 - Format : Select the format of the file to back up.
 - AVI : Codec information provided from the NVR is saved together and can be played in a separate viewer (Windows Media Player, etc.) on the PC.
 - SEC : Proprietary file format, which can be played on the PC immediately as it is saved with a dedicated viewer.
 - When you select the SEC format, you can select or deselect "Password" and "Text data included".
 - Path : displays the location of the folder in which the section backup file is to be saved.
- After completing the backup settings, click the <Backup> button.
 - If you press the <Stop> button during the backup process, the backup will be suspended.

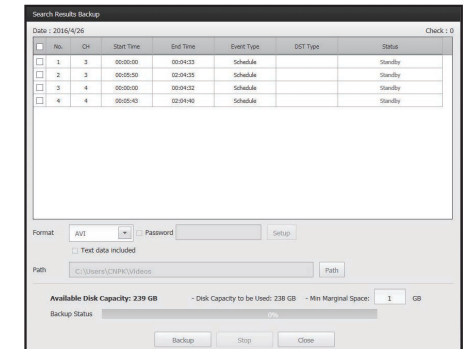

To run the section backup function

You can select and back up a desired section in the timeline or list of video(s) being played.

- Click the [] button.
- On the timeline of a video being played, select the start point and the end point of the section to back up. Section backup settings screen will open.
 - Channel : Displays the channel for the section backup.
 - Backup section : Displays the <Start time> and the <End time> of a section to back up.
 - Format : Selects the format of a section to back up.
 - AVI : Codec information provided from the NVR is saved together and can be played on a separate viewer (Windows Media Player, etc.) on the PC.
 - SEC : Proprietary file format, which can be played on the PC immediately as it is saved with a dedicated viewer.
 - When you select the SEC format, you can select or deselect "Password" and "Text data included".
 - File name : Sets the name of a section backup file.
 - Path : displays the location of the folder in which the section backup file is to be saved.
- After completing the section backup settings, click the <Backup> button.
 - If you press the <Stop> button during the section backup process, the backup will be suspended.

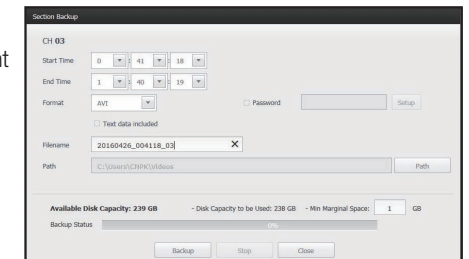

Text Search

You can search data that was entered into POS systems connected to NVR.

If you want to search by a text

1. Select a date and time to search.
2. Set event keywords and search conditions.
 - Search Condition : Enter a text to search.
 - Event Keyword : Searches based on the condition set in "Device > Text > Event settings". (Page 41)
 - <Case Sensitive> : If checked, search terms are case-sensitive.
 - <Whole Word> : If checked, only results that exactly match the input search terms are returned.
3. Click the <Search> button.
 - Refer to <Text Search> for the detailed text search method. (Page 51)

If you want to restore text search

When you enter search conditions and replay the search result with ON/OFF button in the upper right hand, it is possible to query text data.

Names and Functions of Play Buttons

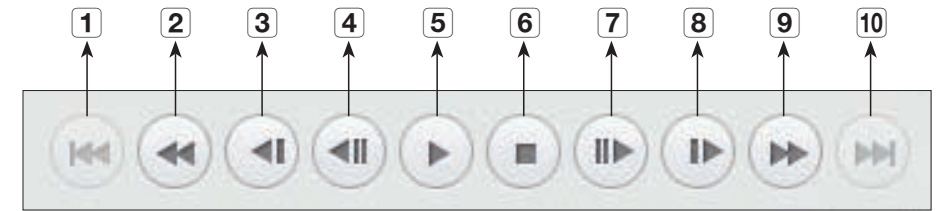

Item	Description
1	Back Returns to the previous event.
2	Rewind Used to rewind a video. (Supports x1, x2, x4, x8, x16, x32, x64, x1, x2 and x4 speed)
3	Slow Rewind Used to rewind the video at a slow speed. (supports x1/2, x1/4, x1/8, x1/2 and x1/4 speed)
4	Previous frame Move to the frame in reverse direction.
5	Play/Pause Video is played and paused.
6	Stop Terminates the video play.
7	Next frame Move to the frame in the forward direction.
8	Slow Play Used to play the video forward at a slow speed. (supports x1/2, x1/4, x1/8, x1/2 and x1/4 speed)
9	Slow Forward Used to play a video forwards. (Supports x1, x2, x4, x8, x16, x32, x64, x1, x2 speed)
10	Move forward Proceeds to the next event.

SETUP VIEWER

You can configure the NVR settings remotely on the network.

To configure the NVR settings, click <Setup>.

Settings Screen

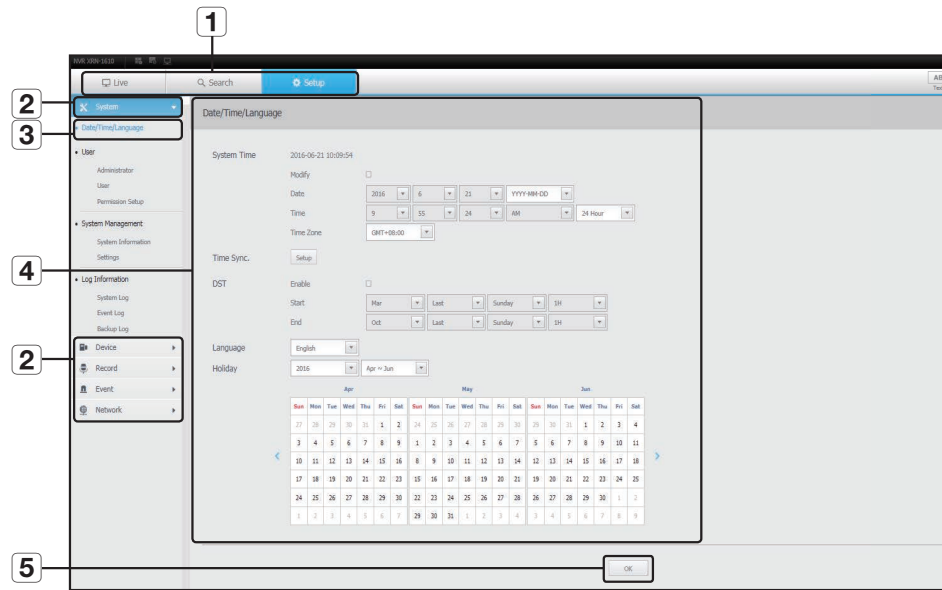

Item	Description
1	Menu Selection Click each menu to switch into corresponding menu screen.
2	Parent Menu Configure the settings or select a parent item to change the existing settings.
3	Sub-Menu Among the sub-menus of selected parent menu, select a desired item to set.
4	Detailed Menu Click desired item's input field to change and enter a desired value.
5	OK Apply the modified settings.

System

You can configure the various settings of the NVR system.

Date/Time/Language

For more information, refer to "Date/Time/Language" in the "System" menu. (Page 27)

Date/Time

Set the date and time.

Time Synchronization Setup

Set the time synchronization.

DST (Daylight Saving Time)

During the summer, Daylight Saving Time (DST) advances clocks one hour forwards from the standard local time zone.

Language

Select a preferred language for the NVR.

Holiday

A user can select specific dates as holidays according to their own preferences.

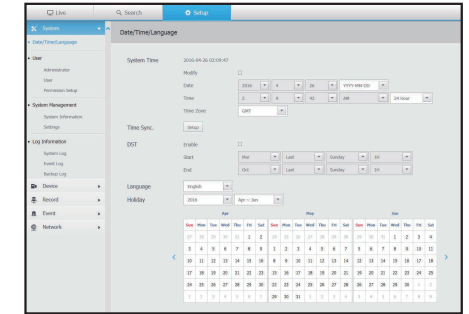

User

For more information, refer to "User" in the "System Setup" menu. (Page 28)

Administrator

You can change the admin ID or the password.

- ID allows alphanumeric characters only.
- If the admin ID is not used for access, you cannot change the ID.
- If the ID being used is changed, you will be automatically logged out.

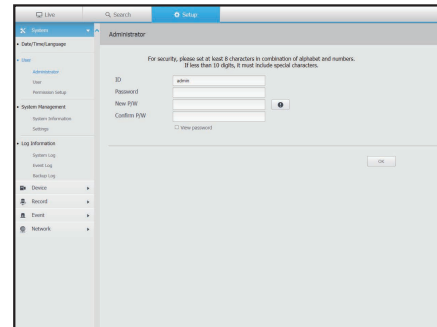

User

You can add, change or remove a user or users.

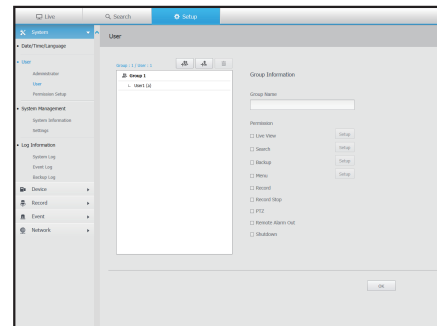

Permission Setup

You can set the user permission.

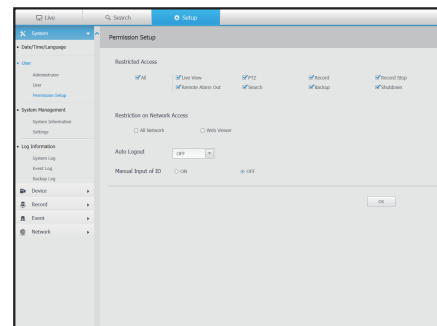

System Management

For more information, refer to "System Management" in the "System" menu. (Page 30)

System Information

You can see information of the current system.

Check the software version and MAC address.

You can search for a file from the storage device connected to the PC to perform an upgrade.

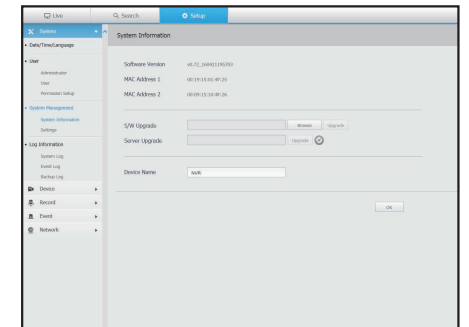

Settings

Using a storage device, you can apply the current configuration of NVR to another NVR.

Press the Initialize button to return the network settings to their factory default state. Items in the <Not Included> category are excluded from the initialization.

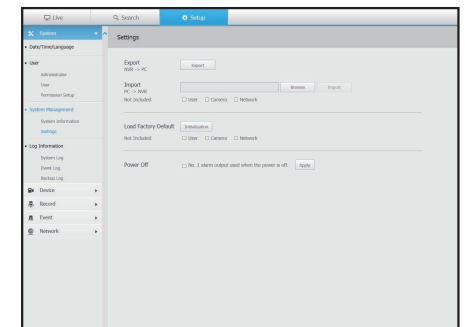

Log information

System log

Data recorded in the system log displays various system-related logs/date/time such as system starts, system ending and menu setting changes.

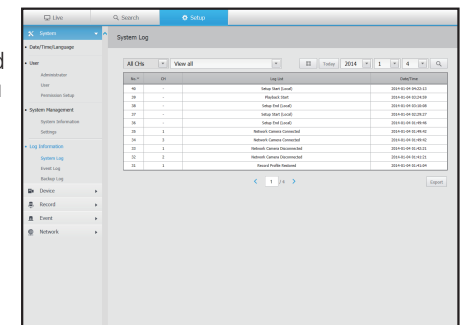

setup viewer

Event log

The event log lists recorded events, such as sensor events, camera events, or video losses.

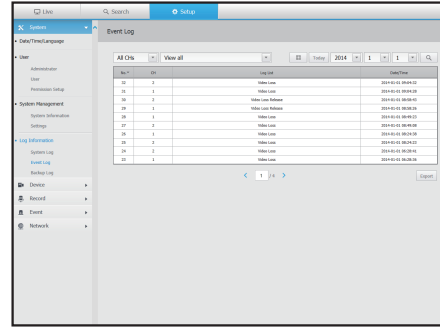

Backup log

You can inquire about a user who performed a backup, execution time, details (backup time, channel, backup device, backup file type).

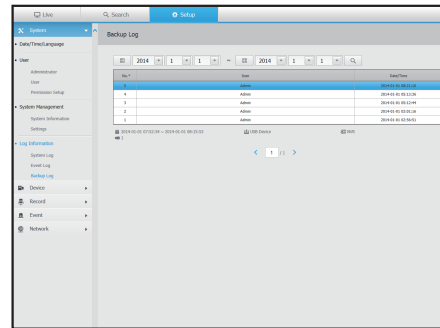

Device

You can check a list of devices that are connected to the NVR and configure the necessary settings. Click <Device> in the menu screen. For more information, refer to "Setting the Device". (Page 32)

Camera

Cam Registration

You can add a network camera(s).

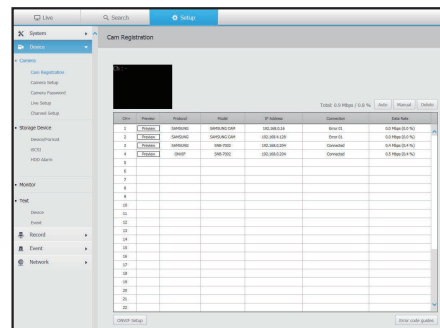

Camera Setup

You can change the settings of a connected network camera.

- When you click the [Camera website] button, a new camera web browser window is opened.
 - When you are connecting to the camera web page on a closed network, a camera that does not support the universal web will not be able to output an image.

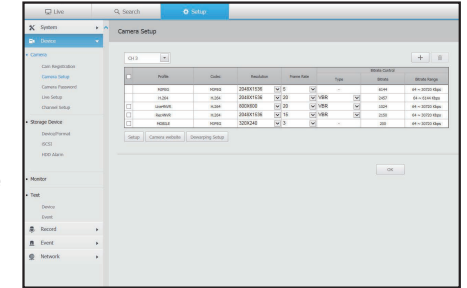

Camera Password

You can change the passwords of all registered cameras at once.

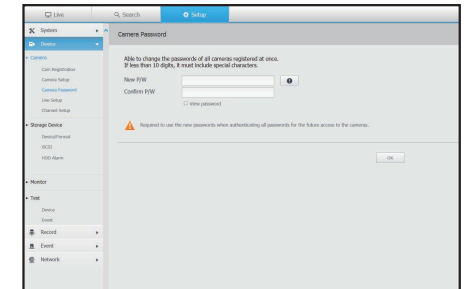

Live Setup

You can change the live transfer settings of the network camera.

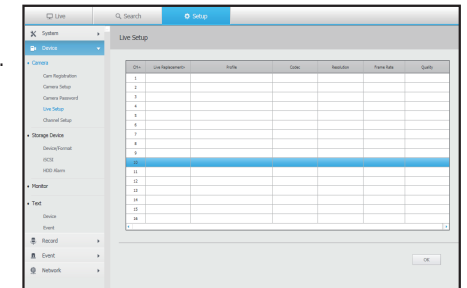

Channel Setup

You can configure the video settings for each channel.

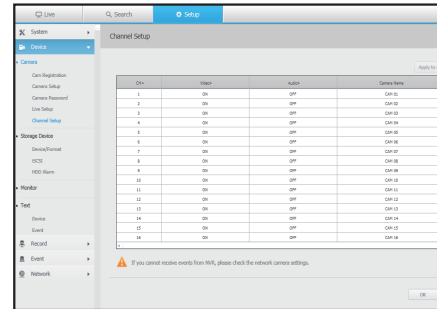

HDD Alarm

You can set the alarm output port and the duration in case an error occurs.

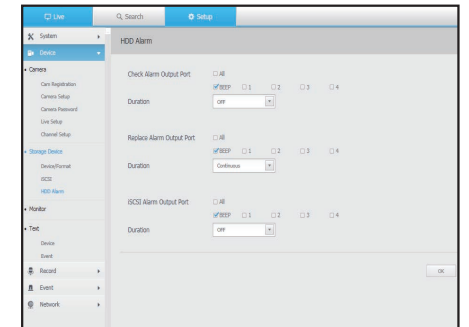

Storage Device

You can check and change the settings related to the data storage device.

Device/format

You can check a storage device, amount of use, type of use and status of storage device.

- ARB : Video that was not recorded due to disconnection from the camera can be backed up after the connection with the camera is re-established. Press the button and an <Auto Recovery Backup> window is opened. For more information about settings, please refer to "Device/Format". (Page 37)

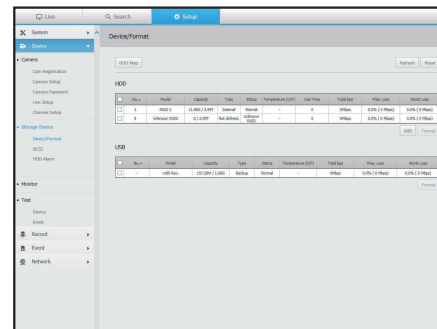

Monitor

Monitor

You can configure the monitoring screen settings and set the output system.

- If the video is not played properly, refer to the troubleshooting section later in this manual. (Page 78)
- The Monitor Setup settings control the monitor connected to the NVR.

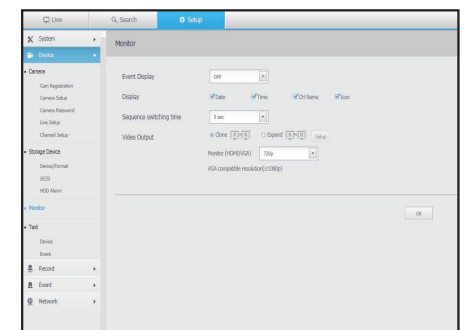

iSCSI

If you connect NVR with an iSCSI device, you can search, connect or disconnect the iSCSI device.

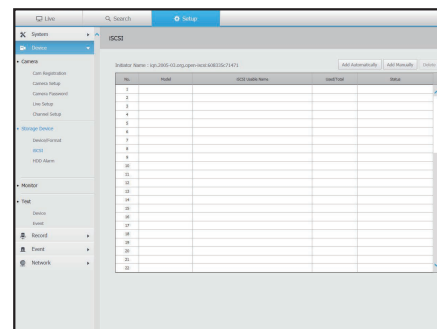

Text

Device

Relevant values of a device connected to NVR can be set.

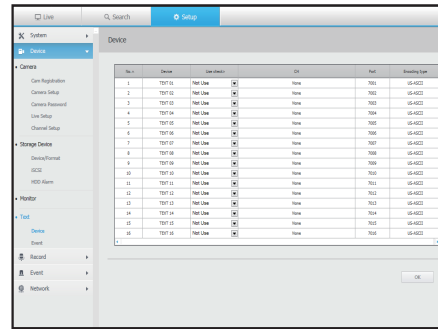

Event

It is possible to set total amount conditions and keywords to display events of a text device.

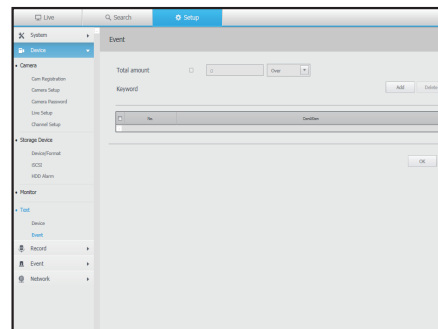

Record

For more information, refer to "Setting the Recording". (Page 41)

Recording Schedule

If you set a recording schedule for a specific date and time, the recording will start at that specific time.

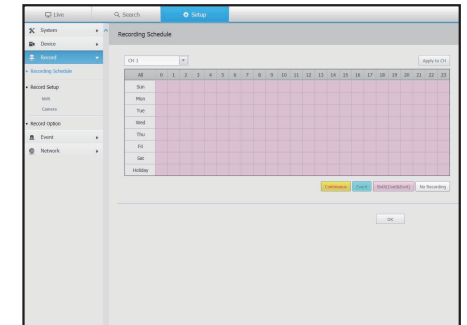

Record Setup

NVR

Select a type of the normal/event recording frame rate for each channel.

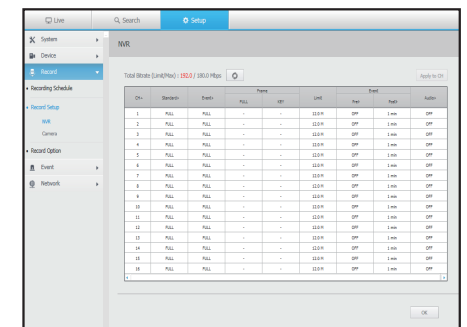

Camera

You can set the recording profile for a network camera.

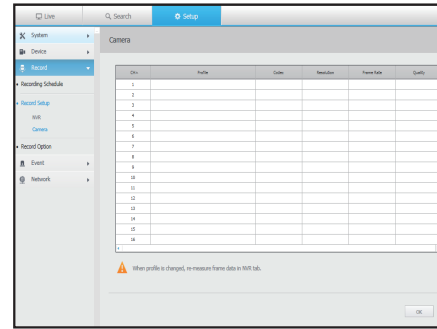

Record Option

You can set the Disk End Mode.

- You can set the recording duration separately for each channel.

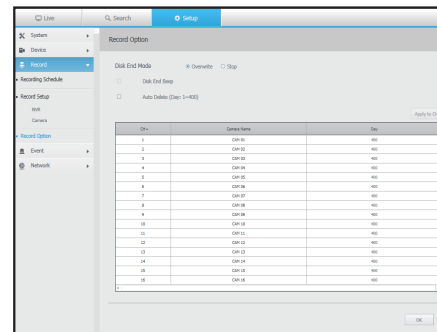

Event

For more information, refer to "Setting the Event". (Page 43)

Sensor Detection

NVR / Camera

You can set the sensor operation mode and the synchronized camera as well as the alarm output type and the duration.

- If the connected network camera that has configured the alarm in/out settings triggers an alarm, NVR will perform the alarm out.

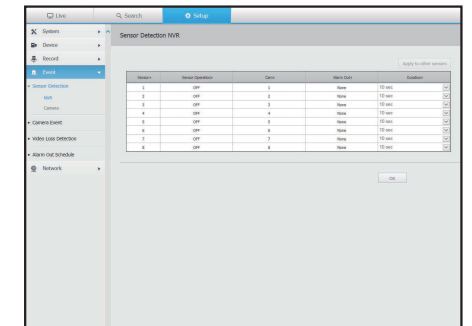

Camera Event

You can set NVR and camera event mode, alarm output type and alarm time.

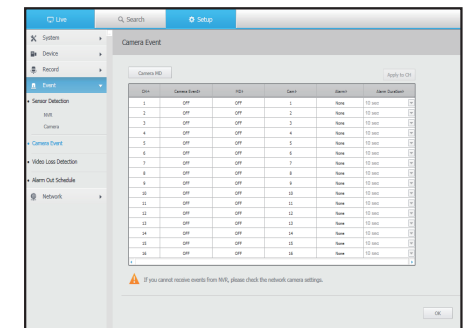

Video Loss Detection

You can set to trigger the alarm if a video loss occurs.

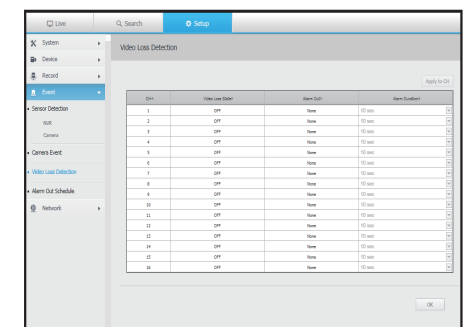

Alarm Out Schedule

You can schedule the alarm output according to the day of the week and the time. The default setting is Event Sync, which activates the alarm only if an event occurs.

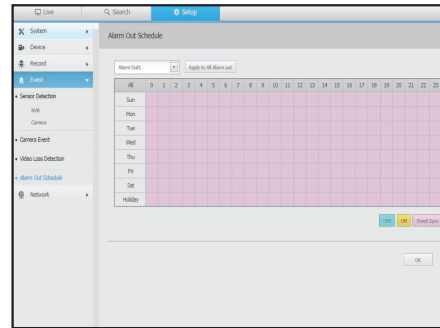

Network

For more information, refer to "Network Configuration". (Page 45)

Interface

A remote user can access the NVR via the network to check the current mode and the IP address.

Network

Specify the network connection path.

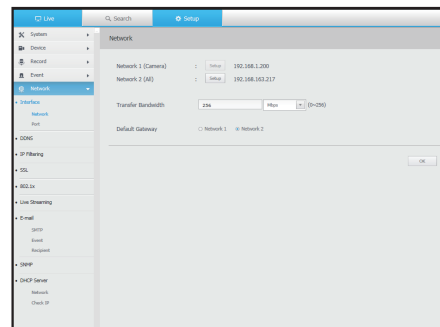

Port

You can configure the protocol related settings.

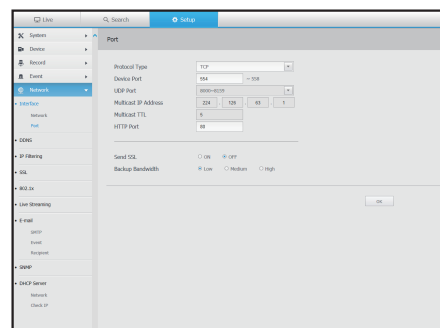

DDNS

Network 1/2

You can check the DDNS settings.

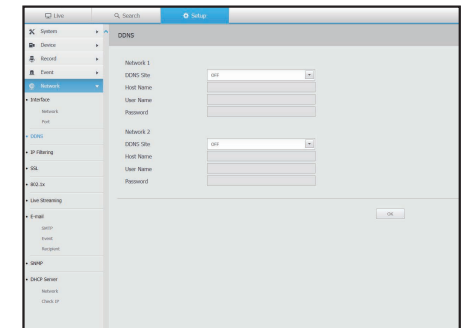

IP Filtering

You can prepare the list of IP address to allow or block accesses to a specific IP address.

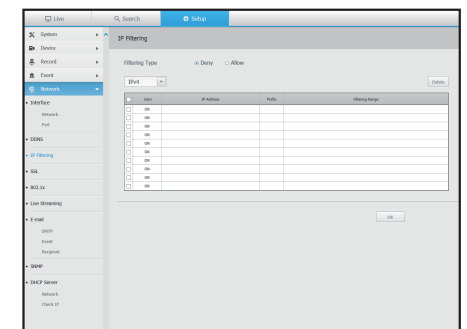

SSL

You can select a security connection system or install public certificates.

- While using HTTPS, if you want to switch to HTTP, then abnormal operation can take place as the browser contains the setting values. You need to change the URL to HTTP and reconnect or initialize the cookie setting of the browser.

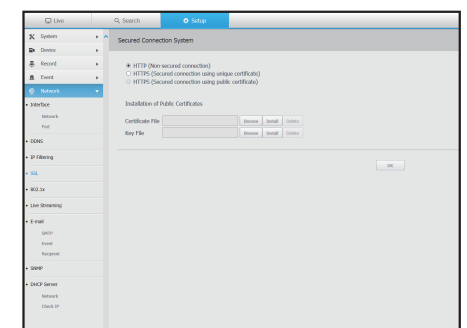

802.1x

When connecting to a network, you can select whether to use the 802.1x protocol and install corresponding certificate.

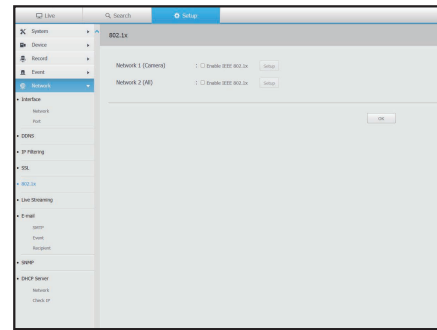

Live Streaming

You can set the video profile transmitted to the network and the expansion monitor.

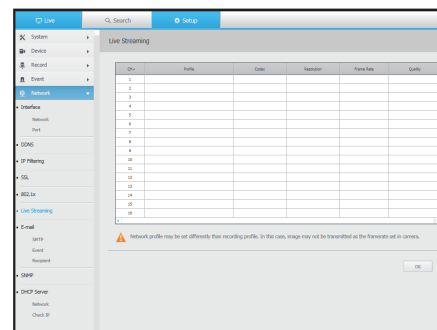

E-mail

You can specify the SMTP server that sends a mail if an event occurs and set the recipient group and users.

SMTP

You can set the server that sends mails and specify if you use the authentication process.

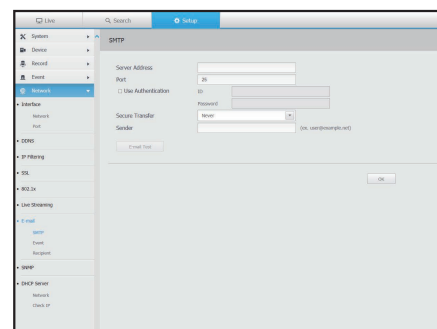

Event

You can set the event interval and specify which events the server sends mails for.

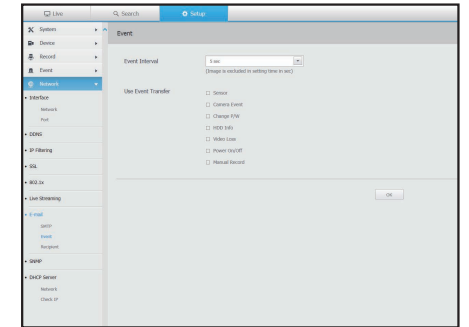

Recipient

You can set groups and recipients to receive emails.

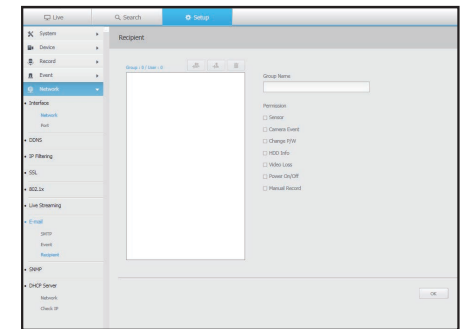

SNMP

Using the SNMP protocol, the system or network administrator can remotely monitoring the network devices and sets the environment.

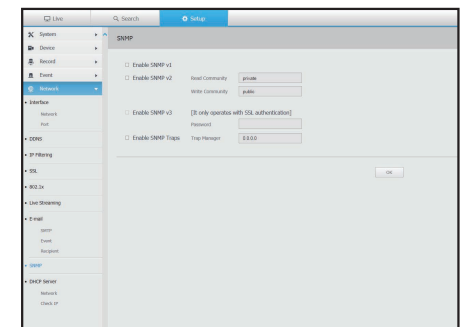

setup viewer

DHCP Server

Network

You can set the internal DHCP server and assign an IP address to the network camera.

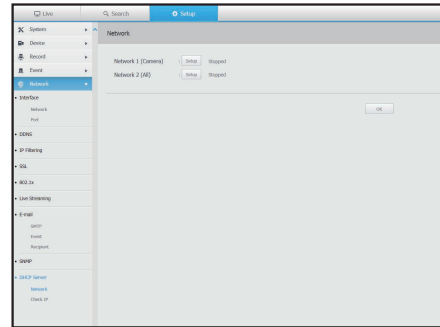

Check IP

You can check the IP and MAC currently used through the DHCP server, and the connected network port.

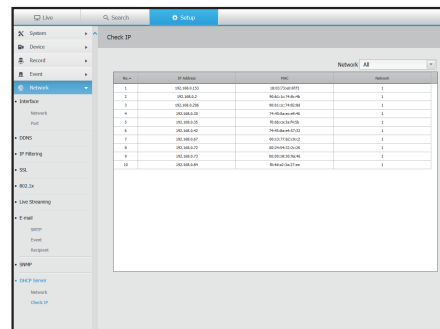

Using the setting icons



In PnP mode no Quick setup icon.

- : If the button is selected, you can turn on/off the function to query text devices and data that are located in a separate area.
- : Display the ID of user connected.

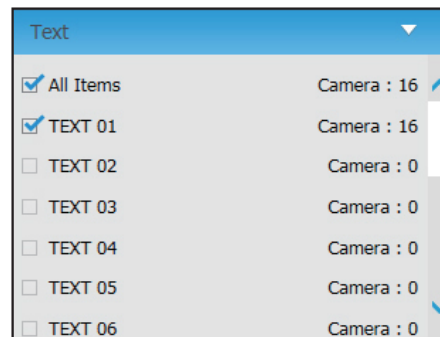

- : You can register a network camera for each channel and easily set the resolution and the number of shots in case of event occurrence or manual recording.
 - For more on how to register a camera, refer to "To register a camera". (Page 32)
 - If the failover mode is in a standby state, <Quick Setup> item is hidden.

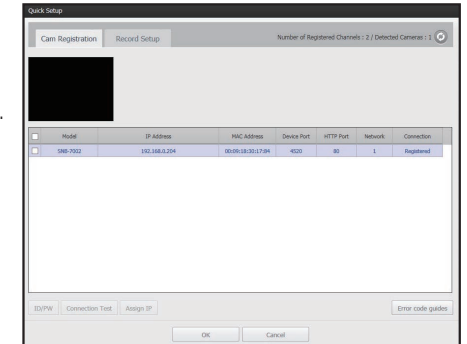

- : You can manually enter the desired backup channel and time/date to backup the recorded video.
 - You can select whether or not to "Text data included" for SEC format.

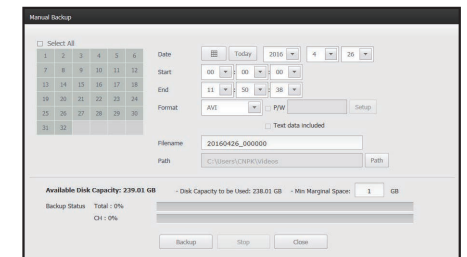

- : You can check the recording status and the status of camera connected.
 - Live : Select <Live> to check the status of camera connected to each channel and the transmission information.
 - Recording : Select <Record> to check the following for each channel : profile, recording type, inputs / recording transmission rate, settings / inputs / amount of recorded data.

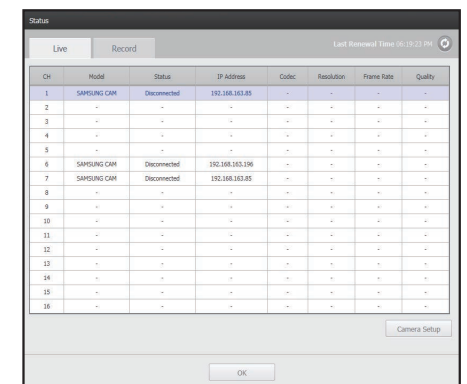

- PoE : Select <PoE> to check the consumption by PoE connected to each channel.
 - Click on < Camera Registration > to move to Device > Camera > Camera Registration. For more on camera registration, refer to "To register a camera". (Page 70)
 - Only XRN-1610S supports PoE status.

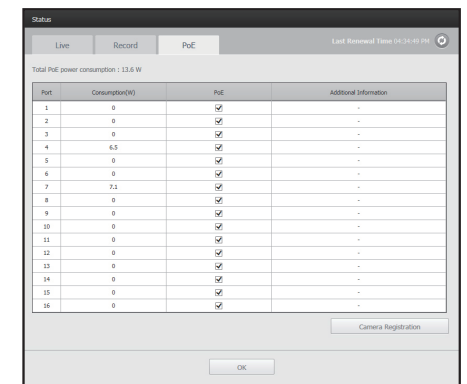

- : You will be immediately directed to the homepage of Hanwha Techwin.

SEC BACKUP VIEWER

You can play a file that is backed up in the format of SEC.

Backup in SEC format produces backup data file, library file and self-executable viewer file.

If you run the backup file viewer, the backup data file will be played.

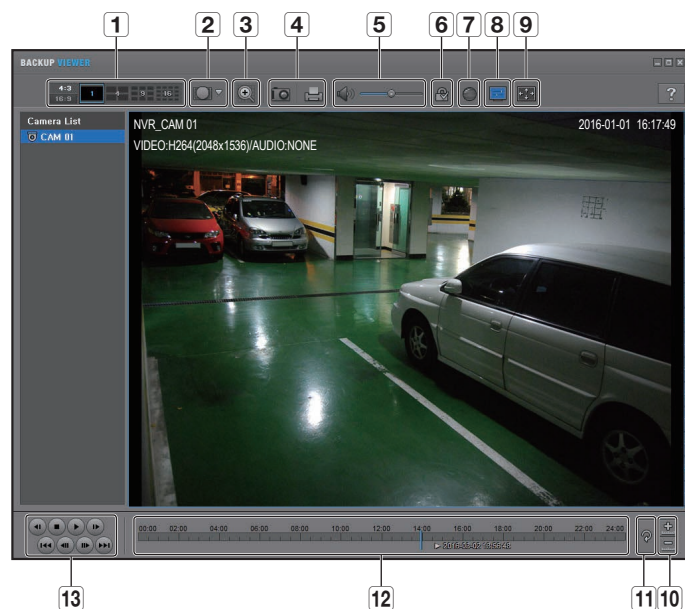

Recommended System Requirements

PCs with a lower specification than the recommended below may not fully support forward/backward and high-speed playback.

- OS : Windows 7
- CPU : Intel Core 2 Quad 2.5GHz or higher
- RAM : 3GB or more
- VGA : Geforce 6200 or higher

Item		Description	
1	Split screen		Selects screen ratio to display.
			The screen is changed to a split screen.
2	Fish eye view mode		If < > is pushed, it is possible to change to a fish eye installation type. It is possible to select WALL/GROUND/CEILING mode according to the installation place.
			The fish eye view mode on the current screen can be changed independently on each split.

Item		Description	
3	Digital Zoom		Enlarge the image by up to 100 times as big as the current one. Press the Zoom In () button to enlarge the image; press the Zoom Out () button to shrink the image. You can also use the slide bar () in the pop-up window to zoom in/out. Press () on a size-changed video to restore the default zoom factor (100%). If you enlarge the image by more than 200%, the enlarged area will be marked on the digital zooming screen. Click on the marked area and move it to a desired position. The digital zooming is applied to all backup viewer. When the digital zooming is canceled, the video size will restore the default rate of 100%.
4	Screen Printout		Saves the current video's image as in an image file. Supports JPEG file format.
			Prints out the current screen. You should have installed the appropriate printer driver before you can print out the screen.
5	Audio		A toggle button. Each time you press this button, the audio output will toggle between activated and deactivated.
			You can adjust the volume level from 0 to 100.
6	Watermark		Press the button to enable file tampering detection, to detect data file forging.
7	Deinterlace		You can enable the De-interlace function.
8	Show OSD		Check the OSD checkbox to display the OSD information on the backup playback screen. Information such as backup date, day of the week, time, model name, and channel number will be displayed on the screen.
			Maintains the aspect ratio of the playback screen.
9	Maintain aspect ratio/Full screen		Maintains the aspect ratio of the playback screen.
			Plays the video on a full screen.
10	Enlarge / Reduce Timeline		Collapses the time range that is displayed on the range bar of the storage time. You can collapse the range bar until the overall range is shortened to 24 hours.
			Enlarges the time range that is displayed on the range bar of the storage time. You can enlarge the range bar until the overall range is extended to 1 minute.
11	Restore Timeline		Restores the timeline to the default.
12	Display of storage time range		Displays the time range of a stored video file. You can move the gridline of the range bar to select a time point to play.
13	Playback Control		You can adjust the video playback of the timeline.

PRODUCT SPECIFICATION

Item	Details	
	XRN-1610	XRN-1610S
Display		
Network Camera	Inputs	Max. 16CH
	Resolution	CIF ~ 12MP
	Protocols	Samsung, ONVIF
Live	Local Display	1x HDMI / 1x VGA
	Multi-Channel Display	Monitor : 1 / 2V / 3V / 4 / 6 / 8 / 9 / 13 / 16 / Auto Sequence Web : 1 / 4 / 9 / 16 / Auto Sequence
Performance		
Operating System	Embedded	Linux
Record	Compression	H.265, H.264, MJPEG
	Recording Bandwidth	128Mbps
	Resolution	CIF ~ 12MP
	Type	Manual, Schedule(Continuous/Event), Event (Pre/Post)
	Event Trigger	Alarm Input, Video Loss, Camera Event(Sensor, MD, Video Analytics) VA Event(Tampering, Enter/Exit, Passing(Virtual- Line, Appearing/ Disappearing, Face Detection, Audio Detection),Defocus Camera Event
	Event Action	e-Mail, PTZ Preset, Alarm Out, Buzzer, Monitor Out
Search & Play	Playback Bandwidth	32Mbps(16ch simultaneously)
	Mode	Date & Time(Calendar)/Event Log list/Text Search(POS, ANPR)
	Simultaneous playback	16 channels(Local, Network)
	Resolution	CIF ~ 12MP
	Playback Control	Fast/Slow Forward/Backward, Move one step up/down
Storage	Built-In	0TB ~ 8TB (dependent on region)
	Internal HDD	8 SATA 4 SATA
	External	1 e-SATA iSCSI storage

Item	Details	
	XRN-1610	XRN-1610S
Backup	File backup	BU/EXE(USB), JPG/AVI(Web, CMS)
	Function	Max. 16CH Play, Date-Time/Title display
Sensor	I/O	8/4 (NO 3EA, NO/NC 1EA)
Audio	Input	16 channels (network)
	Compression	G.711, G.726, AAC(16/48KHz)
	Audio Communication	2-Way
Network		
Protocol	TCP/IP, UDP/IP, RTP (UDP), RTP (TCP), RTSP, NTP, HTTP, DHCP (Server, Client), PPPoE, SMTP, ICMP, IGMP, ARP, DNS, DDNS, uPnP, HTTPS, SNMP, ONVIF (Profile-S), SUNAPI(Server, Client)	
DDNS	iPOLIS DDNS	
Transmission Bandwidth	256Mbps(iSCSI Off), 128Mbps(iSCSI On)	
Max Remote Users	Search(3) / Live unicast(10) / Live multicast(20)	
IP Version	IPv4/v6	
Security	User access Log, IP Filtering, 802.1x, Encryption	
Language	English, French, German, Italian, Spanish, Russian, Turkish, Polish, Dutch, Swedish, Czech, Portuguese, Danish, Rumanian, Serbian, Croatian, Hungarian, Greek, Norwegian, Finnish, Korean, Chinese, Japanese, Thai	
OS	Window 7, 8.1, 10, Mac OS X(10.9 or above)	
Web Browser	Non-plugin Webviewer Supported Browser: Google Chrome 47, MS Edge 20 WMF : 1CH LIVE(800X600), SETUP Plug-in Webviewer Supported Browser: MS Explore 11 , Mozilla Firefox 43 Apple Safari 9 * Mac OS X only	
Viewer Software	Type	SSM, Webviewer, SmartViewer, iPolis Mobile Viewer
	CMS Support	SDK/CGI(SUNAPI)

Item		Details	
		XRN-1610	XRN-1610S
Smart phone	Support Model	Android, I-Phone	
	Protocol Support	RTP, RTSP, HTTP, CGI(SUNAPI)	
	Control	Live(16ch) / Playback(1ch,Max 2MP)	
	Max. Remote Users	Search(3) / Live unicast(10), Multicast (20)	
Functions			
Camera Setup	Register	Auto , Manual	PnP , Manual
	Setup Items	(1) IP Address, Add Profile Edit, Bitrate, Compression, GOP, Quality (2) Camera Event Setup - MD - VA: Tampering, Enter/Exit, Passing(Virtual- Line), Appearing/Disappearing, Face Detection, Audio Detection) (3) Video Setup(Simple Focus, Brightness/Contrast, Flip/Mirror, IRIS, WDR, D&N, SSNR, Shutter, SDR, DIS) (4) Fisheye Dewarping, Hallway View Setup, Camera Webpage	
Camera Control	PoE	-	1) Monitor PoE Power consumption 2) On/Off Control for each PoE camera 3) Remote Reset for each PoE camera
	Time Sync.	-	NVR Time Protocol for PoE Camera (Time sync based on NVR time)
Easy Configuration		Setup Wizard (Language, Date/Time, Network, Auto Camera Configuration)	Setup Wizard (Language, Date/Time, Network, Auto Camera Configuration) selectable between PnP and Manual mode
ARB (Auto Recovery Backup)		yes	
PTZ	Control	Via GUI, Webviewer, SPC-2000(USB)	
	Preset	255 Presets	
System Control		Mouse, IR Remocon, Web, SPC-2000(USB)	
Indicator/Interface			
Front	Indicator	Power Status LED 1EA HDD Action LED 1EA Alarm Status LED 1EA Record Status LED 1EA Network Action LED 1EA Backup LED 1EA	
	Switch	N/A	

Item		Details	
		XRN-1610	XRN-1610S
Connectors	VGA	1 EA (Up to 16 split screen mode Live Support)	
	HDMI	Main : 1 EA (Both Support Live / PB / Setup) - Support upto 4K (3840 x 2160, Single Monitor Mode)	
Connectors	Audio	Out(1EA, RCA, Line)	
	Ethernet	2EA (LAN/WAN, 1Gbps) - LAN : Downlink to Camera/PoE Hub - WAN : Uplink to CMS	
	Alarm	In(8EA, Terminal Block) Out(4EA, Terminal Block)	
	USB	2EA(Front 1(USB2.0), Rear 1(USB3.0))	
	Storage	1 e-SATA	
	Serial	RS-232C	
	Reset	Yes (Factory Reset, Alarm Reset)	
	Power Cord	Included	
System			
Log	Log List	Max. 20000 (System Log, Event Log each)	
Environmental			
Operating Temperature / Humidity		+0°C to +40°C (+32°F to +104°F)	
Humidity		20% ~ 85% RH	
Electrical			
Power		100 to 240 VAC ±10%	
Power Consumption		MAX 200W	MAX 292W
Mechanical			
Color / Material		Black / Metal	
Dimension (WxHxD)		440x88x384.8mm (17.32" x 3.46" x 15.15")	
Weight		5.44kg	5.1kg
Standards			
Approvals		UL, FCC, KC, CB, CE-EMC, CCC, EAC, PSE	

PRODUCT OVERVIEW

• XRN-1610

unit : mm (inches)

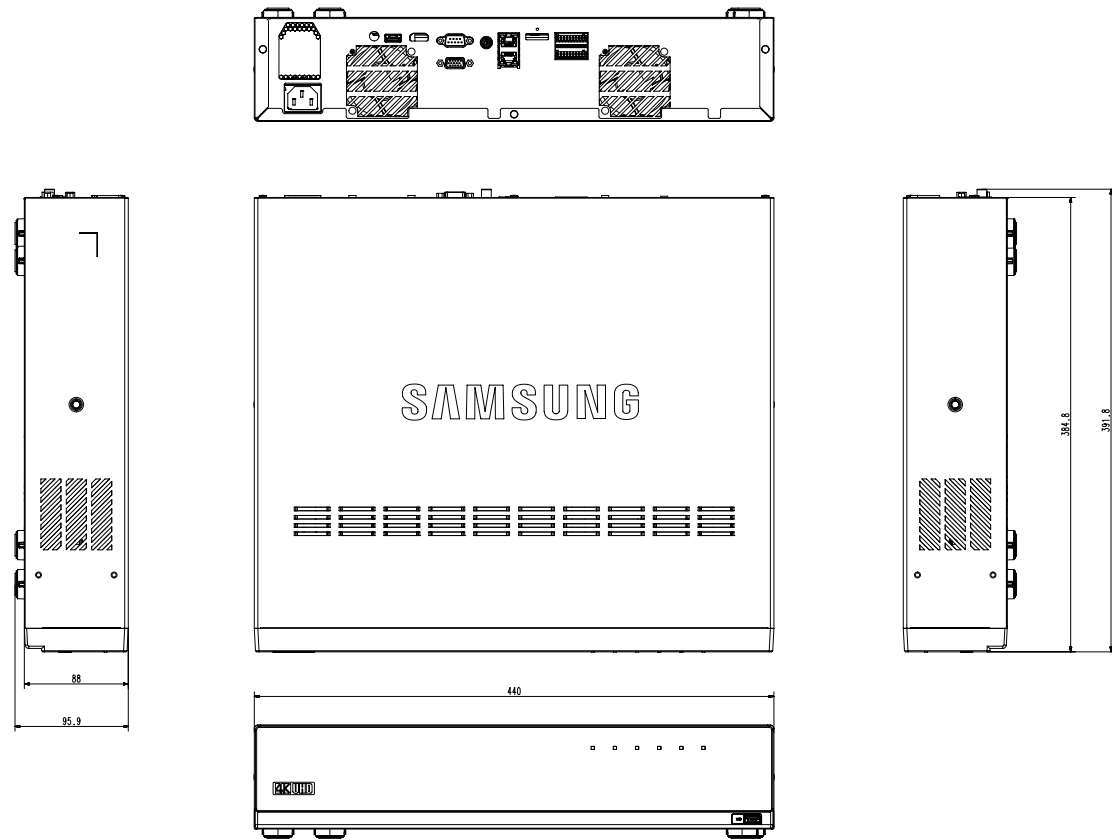

• XRN-1610S

unit : mm (inches)

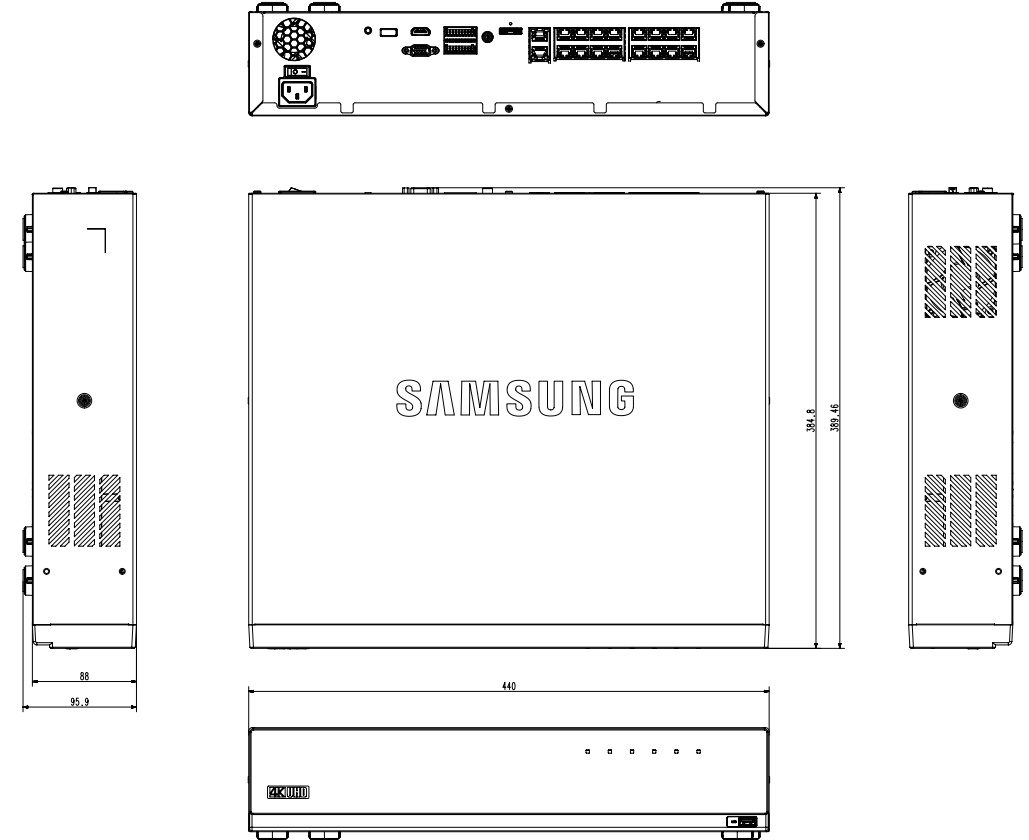

DEFAULT SETTING

To reset the system, move to "**System Management > Settings > Load Factory Default**" and press the **<Initialization>** button.

This returns the factory default settings.

-  When you initialize with the **<Authority Management Settings>** included, you are required to reboot the camera and reset the password.
- The default settings are based on XRN-1610.
- The initial administrator ID is "**admin**" and the password should be set when logging in for the first time.
- Please change your password every three months to safely protect personal information and to prevent the damage of the information theft. Please, take note that it's a user's responsibility for the security and any other problems caused by mismanaging a password.

Category	Details		Factory Default	
System	Date/Time/Language	Date	YYYY-MM-DD	
		Time	24 hours	
		Time Zone	GMT	
		Time Sync.	OFF	
		DST	OFF	
		Language	English	
	User	Admin	ID	admin
		Permission Setup	Restricted Access	Backup/Record/Record Stop/Search/PTZ/Remote Alarm Out/Shutdown
			Restriction on Network Access	None
			Auto Log out	3 Min
			Manual Input of ID	OFF
	System Management	System Information	Device Name	NVR
	Log Information	System Log	Type	View all
		Event Log	Type	View all
Backup Log			OFF	
Device	Camera	Camera Register	OFF	
		Set Camera	OFF	
		Camera Password	OFF	
		Live Setup	OFF	
	Channel Setup	Video	ON	
		Audio	OFF	
		Camera Name	CAM 01 ~ CAM 16	
	Storage Device	Device/Format	Device	HDD
			Usage	
			Status	
Temperature			-	
		Use Time	-	

Category	Details		Factory Default	
Device	Storage Device	iSCSI	OFF	
		HDD Alarm	Check Alarm Output Port	BEEP
			Duration	Continuous
			Replace Alarm Output Port	BEEP
			Duration	Continuous
			iSCSI Alarm Output Port	BEEP
	Duration	Continuous		
	Remote Device	Remote Control	ON	
		ID	00	
	Monitor	Monitor	Event Display	OFF
			Display	All
			Sequence switching time	5 sec
			Video Output	Clone
	Text	Device	Device	TEXT 01~16
Use			Not Used	
Port			7001~7016	
Encoding type			US-ASCII	
Event			Total amount	0
Record	Recording Schedule	CH1~CH16	Both(Cont&Evt)	
	Record Setup	Standard	Full	
		Event	Full	
		Pre Event	OFF	
		POST Event	1 min	
		Audio	OFF	
	Record Option	Disk End Mode	Overwrite	
		Auto Delete	OFF	
Event	Sensor Detection	NVR	Sensor Operation	OFF
			Cam	Camera No.
			Alarm Out	None
		Camera	Duration	10 sec
			Sensor Operation	OFF
			Cam	Camera No.
	Camera Event	Camera	Alarm Out	None
			Duration	10 sec
			Camera Event	OFF
			MD	OFF
			Cam	Camera No.
			Alarm	None
			Alarm Duration	10 sec
			Video loss status	OFF
Alarm Out			None	
Alarm Duration			10 sec	
Alarm Out Schedule	Alarm Out1	Event Sync		

Category	Details		Factory Default	
Network	Interface	Network	IP Type	Static IP
			Network 1(Camera)	192.168.1.200
			Network 2(All)	192.168.2.200
			Subnet Mask	255.255.255.0
			Gateway	192.168.1.1
			DNS	168.126.63.1
		Port	Protocol Type	TCP
			Device Type	554
			UDP Port	8000~8159
			Multicast IP Address	224.126.63.1
			Multicast TTL	5
			HTTP Port	80
			Send SSL	OFF
			Backup Bandwidth	Low
	DDNS	Network1/2	DDNS Site	OFF
	IP Filtering		Filtering Type	Deny
	SSL		Secured Connection System	HTTP (Non-secured connection)
	802.1x	Network	Enable IEEE 802.1x	OFF
	Live Streaming			OFF
	E-Mail	SMTP	Port	25
			Use Authentication	OFF
			Secure Transfer	Never
		Event	Event Interval	10 min
			Use Event Transfer	OFF
		Recipient	Group Name	OFF
	Permission		OFF	
	SNMP		Enable SNMP v1	OFF
Enable SNMP v2			OFF	
Enable SNMP v3			OFF	
Enable SNMP Traps			OFF	
DHCP Server	Network 1(camera)	IP Address	192.168.1.200	
		Subnet Mask	255.255.255.0	
		IP Range	192.168.1.1 ~ 192.168.1.254	
		IP Lease time	86400	
	Network 2(All)	IP Address	192.168.2.200	
		Subnet Mask	255.255.255.0	
		IP Range	192.168.2.1 ~ 192.168.2.254	
		IP Lease time	86400	

TROUBLESHOOTING

Problem	Action
Live video will be slow or cut off.	<ul style="list-style-type: none"> The frame number set for multiple data transmission set in camera or network environment could differ from the actual rate of transmission. Right click with the mouse button and select <Channel Information> to check the number of incoming frames for each channel and the actual number of framed played. Basically, when you register a camera, the Live4NVR profile is created and the rate is set to H.264.800*600fps. If necessary, go to <Menu> → <Device> → <Camera> → <Camera Setting> and change the number of frames. If you keep seeing video slow down or cut off, then check the network environment or camera condition.
The system does not turn on and the indicator on the front panel does not work at all.	<ul style="list-style-type: none"> Check if the power supply system is properly connected. Check the system for the input voltage from the power source. If the problem persists even after you have taken the above actions, check the power supplier and replace it with a new one if necessary. Check inside if the cables are properly connected. (SMPS, FRONT)
Some channels display just a black screen even if they receive video sources.	<ul style="list-style-type: none"> Check if the camera is properly supplied with power. Check the video output connecting the camera's webviewer. Check if the network port is properly connected and the network setting is set correctly. Change the hub supporting Gigabit, it may solves.
The screen displays the logo image repeatedly.	<ul style="list-style-type: none"> This may occur from a problem with the main board, or the related software is corrupt. Contact the nearest service center for more information.
The Channel button does not work on the Live screen.	<ul style="list-style-type: none"> The Channel button does not work if the current screen is in the event monitoring mode.
The cursor will not move to the Start button when I start the calendar search.	<ul style="list-style-type: none"> Check if the channel and the date that you want to play are marked with the V symbol. Both channel and date should be checked before you can start playing with the Start button.
No video is played on the connected monitor.	<ul style="list-style-type: none"> Check if the necessary cables are connected to the monitor properly. Some monitors do not support the NVR output (HDMI or VGA). (NVR output resolution : VGA : 1024*768, 1280*720, 1280*1024, 1920*1080, HDMI : 720P, 1080P, 1440P, 2160P) Check the monitor resolution In case of a 4K video, check whether the cable in use supports HDMI 2.0.

Problem	Action
No response controlling PTZ in the live viewer.	<ul style="list-style-type: none"> • Check the registered Camera if it support PTZ function.
The camera is not connected or the PC fails to connect to the product.	<ul style="list-style-type: none"> • Check if the network cable is connected properly. • Ensure that you have set Network – Connection Mode. • Check the IP setting of the PC or camera. • Try the Ping Test. • Check if there is a different device near the product uses the same IP.
I registered a camera, but the web viewer does not show live video.	<ul style="list-style-type: none"> • After registering a camera, a user need to edit/save the desired layout, before the screen split mode and live screen fit for the setting appears.
In the web viewer, the screen does not switch automatically.	<ul style="list-style-type: none"> • You need to select the desired layout for sequence operation, in the automatic switching menu.
The Live screen is too bright or too dark.	<ul style="list-style-type: none"> • Check the video settings of the registered camera.
A message of "Need to reset date/time." Is displayed on the screen.	<ul style="list-style-type: none"> • This message is displayed if there occurs a problem with the time setting of the internal clock or an error in the clock itself. Contact the retailer or the service center for more information.
The time bar is not displayed in Search mode.	<ul style="list-style-type: none"> • The timeline can switch between normal and extension mode. In extension mode, the time bar may not be displayed in the current timeline. Switch to normal mode or use the left or right button to navigate through the time bar.
The "NO HDD" icon and an error message are displayed.	<ul style="list-style-type: none"> • Check the HDD for connection. If the problem persists in a normal condition, contact the nearest service center to have the HDD checked by the service personnel.
I have installed an additional HDD on the NVR but it does not recognize the HDD.	<ul style="list-style-type: none"> • See the compatibility list to check if the additional HDD is supported by the NVR. For the compatibility list, contact the retailer where you purchased the NVR.
I have connected an external storage device (USB Memory, USB HDD) to the NVR but the NVR seems not to recognize it.	<ul style="list-style-type: none"> • See the compatibility list of external storage devices to check if the connected device is supported by the NVR. For the compatibility list, contact the retailer where you purchased the NVR.
If I press the ESC key in full screen mode of the WebViewer, the system does not switch to a normal split mode.	<ul style="list-style-type: none"> • Press the ALT+TAB keys to select 'ACTIVE MOVIE' and press the ESC key again. The system will switch to a normal split mode.
I found it difficult to configure the network settings if using the default search, backup and router settings.	<ul style="list-style-type: none"> • For more information, refer to the user manual. • If you want to check the basics of the product for a quick start, refer to the quick start guide (backup, search). • If you use the router for network connection, refer to the "Connecting and Setting the Network" section in this manual.

Problem	Action
I forgot the password.	<ul style="list-style-type: none"> • Contact the NVR administrator for help.
Backup data is just not played by the PC or NVR.	<ul style="list-style-type: none"> • When you are backing up data, you have choices about the player either: PC or NVR. Make your selection before proceeding. • If you are using the PC to play the data, the format of the backup file should be either SEC. • If you are using the NVR for this purpose, formatting backup files should be done by the NVR.
Recording does not work.	<ul style="list-style-type: none"> • If your player does not display a Live image at all, that indicates recording does not work so first check if you see an image on the screen. • Recording does not work if the recording settings are not properly configured Scheduled Record: Specify a desired time in Menu – Record – Recording Schedule. Recording will start at the specified time. <ul style="list-style-type: none"> - <Continuous> Record: Recording will proceed in any conditions at the specified time. - <Event> Record: When an event occurs, recording will perform only if the event is of alarm, motion detection and video loss. If there is no event found, recording will not perform. - <Continuous / Event> Record: If there is no event found, Continuous recording will perform. Whereas, if an event occurs, Event recording will perform.
The image quality of the recording data is not good.	<ul style="list-style-type: none"> • Increase the resolution and quality level in Menu – Record – Quality / Resolution. <ol style="list-style-type: none"> 1) Resolution: Select a bigger size when specifying the recording size. The recording image in the CIF format shows a deteriorated quality as it is enlarged from a small-sized image. 2) Record Quality: Specify a bigger level for the recording quality. • If you increase the resolution and the recording quality, the data size increases accordingly. So the HDD will be filled faster. Overwriting will overwrite the existing data so recording will proceed at a shorter interval.
Frame rate of the actual recording does not match that of configured to the camera.	<ul style="list-style-type: none"> • If multiple profiles were applied to one camera for video transmission, the actual video stream can be serviced by the camera at a lower frame rate than specified. Configure your camera to use one profile for data streaming as possible. For example, if you set the same profile for recording and network profiles, the actual recording is made at the specified frame rate. Still, live video display using split screen mode may apply yet another profile to camera in accordance with the used screen mode. Note that allowed limit bitrate for recording / recording settings should be set to be bigger values than that of camera's feed.

Problem	Action
<p>In the recording setting screen, the permitted level for a specific channel is displayed in orange.</p>	<ul style="list-style-type: none"> • If the input data is greater than the permitted level for each channel, it is displayed in orange. Set the permitted data limit to higher than the amount of input data. • If the sum of input data for each channel exceeds the limit, the alarm icon will be displayed. In this case, the channel exceeding the input limit does not record the entire frame, but it records the main frame only(one or two per sec).
<p>In the live screen, the [] icon is displayed and the message window saying " recording data load exceeds the limit. Check it in the record setting." pops up.</p>	<ul style="list-style-type: none"> • If the sum of input data for each channel exceeds the limit, the alarm icon and the pop up window will be displayed. In this case, the channel exceeding the input limit does not record the entire frame, but it records the main frame only(one or two per sec). • Set the permitted data limit to higher than the amount of input data entered in the record setting menu (page 41).
<p>Recording is not performed in accordance with the settings.</p>	<ul style="list-style-type: none"> • If the recording status displays 'Exceeds the maximum hard disc performance', set the recording size according to the recording performance specifications for each HDD condition. (Refer to "Record Settings" in the menu settings. (Page 41))
<p>The iSCSI disconnect icon and the error message pop up window will appear.</p>	<ul style="list-style-type: none"> • Check if the iSCSI port is connected to the network cable. • Check the IP address setting of the iSCSI equipment. • Try a ping test.
<p>The recording screen will slow down.</p>	<ul style="list-style-type: none"> • Check whether the recording performance specifications for each HDD condition match the actual recording settings. (Refer to "Record Settings" in the menu settings. (Page 41)) • If the data volume of a video exceeds the playing performance, only the main frame is played. (Refer to "Product Specifications" in the appendix. (Page 74))
<p>If recording loss persists continuously</p>	<ul style="list-style-type: none"> • Reset the camera recording profile to let the entire recording bps size fit the recording performance for each HDD condition. (Refer to "Record Settings" in the menu settings. (Page 41)) <ul style="list-style-type: none"> ▪ Check the HDD status and determine whether inspection or replacement is necessary. (Refer to "Storage Device" in the menu settings. (Page 35))
<p>Failed to recognize an E-SATA device.</p>	<ul style="list-style-type: none"> • Please remove the power plug of the NVR and E-SATA, and then try connecting them again.

OPEN SOURCE LICENSE REPORT ON THE PRODUCT

The software included in this product contains copyrighted software that is licensed under the GPL, LGPL, MPL 1.1, BSD 2-Clause License, BSD 3-Clause License, MIT License, libxml2 License, Apache 2.0 License, zlib/libpng License, Boost Software License, Curl License, Microsoft Public License, Code Project Open 1.02 License, JPEG License, RSA MD4 or MD5 Message-Digest Algorithm License, PHP License 3.01, OpenSSL Combined License, PCRE 5 License, NTP License, CodeIgniter License, GLUT for Win32 License, ISC License, Brian Gladman Alternate License. You may obtain the complete Corresponding Source code from us for a period of three years after our last shipment of this product by sending email to help.cctv@hanwha.com

If you want to obtain the complete Corresponding Source code in the physical medium such as CD-ROM, the cost of physically performing source distribution might be charged.

For more details about Open Source, refer to the CD or Hanwha Website.

- **GPL Software:** bonnie++ 1.03e, busybox 1.23.2, dibbler 0.8.4, Linux Kernel 3.10.y, ethtool-3.11, lsscsi-0.28, memtester 4.0.5, mii-tool-1.8.11, mtd-utils-1.5.1, smartmontools-6.4, udhcp-0.9.8, wpa-supPLICANT-0.7.3, xfsprogs-3.1.11, gdb-7.8.1, msmtP-1.4.21, parted-3.1, wget-1.14
- **LGPL Software:** ffmpeg-2.4.3, glibc 2.16, Live555, Qt 4.7.2
- **MPL 1.1:** npapi-sdk
- **BSD 2-Clause License:** FreeBSD
- **BSD 3-Clause License:** miniupnpc-1.5-ppc, net-snmp-5.6.2.1, ppp-2.4.5, jquery.sha256, jsbn, libjpeg-turbo, lighttpd, msinttypes, requires, spherall++, sprintf 0.7, System-Verilog-Packet-Library, Text OpenGL Extension Wrangler Library 1.7.0
- **MIT License:** aptechcmsv2, avropendous, cJSON, cJSON-Dave Gamble, dynatree, javascript-ipv6, jqGrid, jQuery UI, jquery-form, jquery-hashchange, jquery-json, jquery-numeric, jquery-throttle-debounce 1.1, JS-Browser-Driver, moon9, noty, Raphael JavaScript Library, wildflower 1.3.Beta
- **libxml2 License:** libxml2 2.7.7
- **Apache 2.0 License:** RLLib
- **zlib/libpng License:** cximage, HM NIS Edit, Nullsoft Scriptable Install System 2.46, PNG reference library, tinyxml 2.6.2, zlib
- **Boost Software License:** boost 1.57.0
- **Curl License:** curl 7.47.0
- **Microsoft Public License:** Minima, Text Designer Outline Text Library
- **Code Project Open 1.02 License:** CPPSQLite - C++ Wrapper for SQLite, A reusable, high performance, socket server class - Part3
- **JPEG License:** libjpeg-8b
- **RSA MD4 or MD5 Message-Digest Algorithm License:** JavaScript MD5 1.1, sipxtapi
- **PHP License 3.01:** HPHP-2.1.0, PHP 5.6.14
- **OpenSSL Combined License:** OpenSSL 0.9.8.zh
- **PCRE 5 License:** pcre 8.31
- **NTP License:** ntp 4.2.8p4
- **CodeIgniter License:** CodeIgniter
- **GLUT for Win32 License:** GLUT for Win32
- **ISC License:** dhcp 4.3-2rc2
- **Brian Gladman Alternate License:** AES with the VIA ACE
- **Acknowledgement:** This product includes modified version of ffmpeg, Live555, Qt 4.7.2, and npapi-sdk.



Hanwha Techwin cares for the environment at all product manufacturing stages, and is taking measures to provide customers with more environmentally friendly products.

The Eco mark represents Hanwha Techwin's devotion to creating environmentally friendly products, and indicates that the product satisfies the EU RoHS Directive.

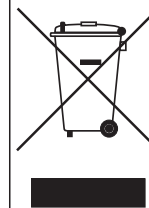

Correct Disposal of This Product (Waste Electrical & Electronic Equipment)

(Applicable in the European Union and other European countries with separate collection systems)

This marking on the product, accessories or literature indicates that the product and its electronic accessories (e.g. charger, headset, USB cable) should not be disposed of with other household waste at the end of their working life. To prevent possible harm to the environment or human health from uncontrolled waste disposal, please separate these items from other types of waste and recycle them responsibly to promote the sustainable reuse of material resources.

Household users should contact either the retailer where they purchased this product, or their local government office, for details of where and how they can take these items for environmentally safe recycling.

Business users should contact their supplier and check the terms and conditions of the purchase contract. This product and its electronic accessories should not be mixed with other commercial wastes for disposal.



Correct disposal of batteries in this product

(Applicable in the European Union and other European countries with separate battery return systems.)

This marking on the battery, manual or packaging indicates that the batteries in this product should not be disposed of with other household waste at the end of their working life. Where marked, the chemical symbols Hg, Cd or Pb indicate that the battery contains mercury, cadmium or lead above the reference levels in EC Directive 2006/66. If batteries are not properly disposed of, these substances can cause harm to human health or the environment.

To protect natural resources and to promote material reuse, please separate batteries from other types of waste and recycle them through your local, free battery return system.

Head Office

86 Cheonggyecheon-ro Jung-gu Seoul 04541 Korea

Tel +82.2.729.5277, 5254 Fax +82.2.729.5489

www.hanwha-security.com

Hanwha Techwin America

100 Challenger Rd. Suite 700 Ridgefield Park, NJ 07660

Toll Free +1.877.213.1222 Direct +1.201.325.6920

Fax +1.201.373.0124

Hanwha Techwin Europe

2nd Floor, No. 5 The Heights, Brooklands, Weybridge, Surrey,
KT13 0NY, UK

Tel +44.1932.82.6700 Fax +44.1932.82.6701
