

# High Resolution Weatherproof IR Camera

User Manual

SC0-6083R



**SAMSUNG**

CE



SAMSUNG

# High Resolution Weatherproof IR Camera

## User Manual

---

### Copyright

©2016 Hanwha Techwin Co., Ltd. All rights reserved.

### Trademark

Each of trademarks herein is registered. The name of this product and other trademarks mentioned in this manual are the registered trademark of their respective company.

### Restriction

Copyright of this document is reserved. Under no circumstances, this document shall be reproduced, distributed or changed, partially or wholly, without formal authorization.

### Disclaimer

Samsung makes the best to verify the integrity and correctness of the contents in this document, but no formal guarantee shall be provided. Use of this document and the subsequent results shall be entirely on the user's own responsibility. Samsung reserves the right to change the contents of this document without prior notice.

❖ Design and specifications are subject to change without prior notice.

Before operating the camera, confirm the camera model and correct input power voltage. To help you understand this manual thoroughly, we'll introduce our model description.

■ SCO-6083R SERIES

- NTSC MODEL  
SCO-6083RN

- PAL MODEL  
SCO-6083RP

■ MODEL DESCRIPTION

- SCO-6083RX



- SIGNAL SYSTEM  
N → NTSC MODEL  
P → PAL MODEL

# safety information

---



## CAUTION

RISK OF ELECTRIC SHOCK.  
DO NOT OPEN



### CAUTION:

TO REDUCE THE RISK OF ELECTRIC SHOCK, DO NOT REMOVE COVER (OR BACK) NO USER SERVICEABLE PARTS INSIDE. REFER SERVICING TO QUALIFIED SERVICE PERSONNEL.



This symbol indicates that dangerous voltage consisting a risk of electric shock is present within this unit.



This exclamation point symbol is intended to alert the user to the presence of important operating and maintenance (servicing) instructions in the literature accompanying the appliance.

## WARNING

- To prevent damage which may result in fire or electric shock hazard, do not expose this appliance to rain or moisture.
- To prevent injury, this apparatus must be securely attached to the floor/wall in accordance with the installation instructions.

## WARNING

1. Be sure to use only the standard adapter that is specified in the specification sheet. Using any other adapter could cause fire, electrical shock, or damage to the product.
2. Incorrectly connecting the power supply or replacing battery may cause explosion, fire, electric shock, or damage to the product.
3. Do not connect multiple cameras to a single adapter. Exceeding the capacity may cause abnormal heat generation or fire.
4. Securely plug the power cord into the power receptacle. insecure connection may cause fire.
5. When installing the camera, fasten it securely and firmly. The fall of camera may cause personal injury.

6. Do not place conductive objects (e.g. screwdrivers, coins, metal parts, etc.) or containers filled with water on top of the camera. doing so may cause personal injury due to fire, electric shock, or falling objects.
7. Do not install the unit in humid, dusty, or sooty locations. doing so may cause fire or electric shock.
8. If any unusual smells or smoke come from the unit, stop using the product. in such case, immediately disconnect the power source and contact the service center. continued use in such a condition may cause fire or electric shock.
9. If this product fails to operate normally, contact the nearest service center. never disassemble or modify this product in any way. (samsung is not liable for problems caused by unauthorized modifications or attempted repair.)
10. When cleaning, do not spray water directly onto parts of the product. doing so may cause fire or electric shock.

## CAUTION

1. Do not drop objects on the product or apply strong shock to it. Keep away from a location subject to excessive vibration or magnetic interference.
2. Do not install in a location subject to high temperature (over 55°C), low temperature (below -30°C), or high humidity. Doing so may cause fire or electric shock.
3. If you want to relocate the already installed product, be sure to turn off the power and then move or reinstall it.
4. Remove the power plug from the outlet when there is a lightning. Neglecting to do so may cause fire or damage to the product.
5. Keep out of direct sunlight and heat radiation sources. It may cause fire.
6. Install it in a place with good ventilation.
7. Avoid aiming the camera directly towards extremely bright objects such as sun, as this may damage the CMOS image sensor.
8. Apparatus shall not be exposed to dripping or splashing and no objects filled with liquids, such as vases, shall be placed on the apparatus.
9. The Mains plug is used as a disconnect device and shall stay readily operable at any time.
10. Do not expose the camera to radioactivity. Radioactivity exposure may damage the CMOS.

# safety information

---

## FCC Statement

This device complies with part 15 of the FCC Rules. Operation is subject to the following two conditions :

- 1) This device may not cause harmful interference, and
- 2) This device must accept any interference received including interference that may cause undesired operation.

## CAUTION

This equipment has been tested and found to comply with the limits for a Class A digital device, pursuant to part 15 of FCC Rules. These limits are designed to provide reasonable protection against harmful interference when the equipment is operated in a commercial environment. This equipment generates, uses, and can radiate radio frequency energy and, if not installed and used in accordance with the instruction manual, may cause harmful interference to radio communications. Operation of this equipment in a residential area is likely to cause harmful interference in which case the user will be required to correct the interference at his own expense.



## IC Compliance Notice

This Class A digital apparatus meets all requirements of the Canadian Interference.-Causing Equipment Regulations of ICES-003.



## Correct Disposal of This Product (Waste Electrical & Electronic Equipment)

(Applicable in the European Union and other European countries with separate collection systems)

This marking on the product, accessories or literature indicates that the product and its electronic accessories (e.g. charger, headset, USB cable) should not be disposed of with other household waste at the end of their working life. To prevent possible harm to the environment or human health from uncontrolled waste disposal, please separate these items from other types of waste and recycle them responsibly to promote the sustainable reuse of material resources.

Household users should contact either the retailer where they purchased this product, or their local government office, for details of where and how they can take these items for environmentally safe recycling.

Business users should contact their supplier and check the terms and conditions of the purchase contract. This product and its electronic accessories should not be mixed with other commercial wastes for disposal.



## Correct disposal of batteries in this product

(Applicable in the European Union and other European countries with separate battery return systems.)

This marking on the battery, manual or packaging indicates that the batteries in this product should not be disposed of with other household waste at the end of their working life. Where marked, the chemical symbols Hg, Cd or Pb indicate that the battery contains mercury, cadmium or lead above the reference levels in EC Directive 2006/66. If batteries are not properly disposed of, these substances can cause harm to human health or the environment.

To protect natural resources and to promote material reuse, please separate batteries from other types of waste and recycle them through your local, free battery return system.

# important safety instructions

1. Read these instructions.
2. Keep these instructions.
3. Heed all warnings.
4. Follow all instructions.
5. Do not use this apparatus near water.
6. Clean only with dry cloth.
7. Do not block any ventilation openings. Install in accordance with the manufacturer's instructions.
8. Do not install near any heat sources such as radiators, heat registers, or other apparatus (including amplifiers) that produce heat.
9. Do not defeat the safety purpose of the polarized or grounding-type plug. A polarized plug has two blades with one wider than the other. A grounding type plug has two blades and a third grounding prong. The wide blade or the third prong is provided for your safety. If the provided plug does not fit into your outlet, consult an electrician for replacement of the obsolete outlet.
10. Protect the power cord from being walked on or pinched particularly at plugs, convenience receptacles, and the point where they exit from the apparatus.
11. Only use attachments/accessories specified by the manufacturer.
12. Use only with cart, stand, tripod, bracket, or table specified by the manufacturer, or sold with the apparatus.
13. Unplug this apparatus when a card is used. Use caution when moving the cart/ apparatus combination to avoid injury from tip-over.
14. Refer all servicing to qualified service personnel. Servicing is required when the apparatus has been damaged in any way, such as powersupply cord or plug is damaged, liquid has been spilled or objects have fallen into the apparatus, the apparatus has been exposed to rain or moisture, does not operate normally, or has been dropped.



Apparatus shall not be exposed to dripping or splashing and no objects filled with liquids, such as vases, shall be placed on the apparatus



Samsung cares for the environment at all product manufacturing stages, and is taking measures to provide customers with more environmentally friendly products.

The Eco mark represents Samsung's devotion to creating environmentally friendly products, and indicates that the product satisfies the EU RoHS Directive.

# contents

---

## INTRODUCTION

9

- 9 Features
- 10 Components and Accessories
- 11 Component names and functions

## CONNECTION

14

- 14 Connecting to Monitor
- 14 Connecting to Power
- 15 Using Coaxial Communications

## CAMERA OPERATION

17

- 17 Menu Configuration
- 17 Menu Setup

## TROUBLESHOOTING

29

- 29 Troubleshooting

## SPECIFICATIONS

30

- 30 Specifications
- 32 Dimension



## FEATURES

---

- **High Resolution**

Use of a 2M pixel CMOS device provides clear pictures with a horizontal resolution of 1000TVL.

- **Excellent Sensitivity**

The built-in high sensitivity COLOR CMOS produces a clear image.

– Color : 0.2Lux (F1.4, 50IRE); 0.11Lux (F1.4, 30IRE)

B/W : 0Lux(IR LED on)

- **SSNR4 (Samsung Super Noise Reduction) Function**

High performance NVP2440H Chip removes noises of GAIN resulting from the low light level and shows a vivid, high definition video even in the dark place.

- **Day&Night**

This camera has a function that automatically selects the mode that is appropriate for daytime or night-time conditions. The COLOR mode operates in daytime conditions to provide optimum colors, and B/W mode operates in night-time conditions to enhance the definition of the image.

- **PROFILE**

You can set a mode according to the camera installation conditions.

- BASIC, DAYNIGHT, BACKLIGHT, ITS, INDOOR, USER

- **D-WDR**

By adopting a proprietary NVP2440H chip, the camera delivers clear, high quality pictures even in backlight, by increasing exposure in dark areas while decreasing it in bright areas; a corrected image with clear details results.

- **Miscellaneous Functions**

HLC(High Light Compensation), REVERSE , SHARPNESS and PRIVACY functions are provided.

- **Communication**

Coaxial communication methods are supported.

- Coaxial Communications : ACP(Analog Coaxial Protocol)

- **OSD**

The camera's OSD is complimented by 16 languages.

- English, Korean, Japanese, German, Italian, French, Spanish, Russian, Czech, Polish, Romanian, Serbian, Swedish, Danish, Turkish, Portuguese

## COMPONENTS AND ACCESSORIES

---

Check if the following items are included in the product package.



SCO-6083R



Quick Manual



Screws



Template



Wrench



Card-type moisture  
absorbent

## COMPONENT NAMES AND FUNCTIONS

### Front

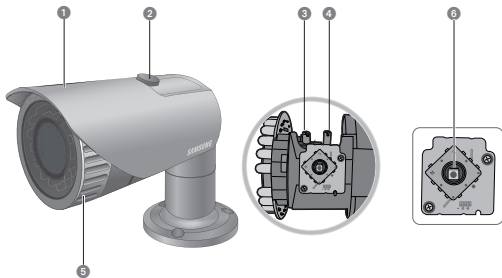

- ❶ **Camera Sunshield**
- ❷ **Knob Sunshield** : Fixing the sunshield onto the camera.
- ❸ **Focus lever** : Set focus of lens by turn the focus lever.
- ❹ **Zoom lever** : Set zoom magnification of lens by turn the zoom lever.
- ❺ **Front cover**
- ❻ **Function Setup Switch** : Display the menu on the screen and move the cursor to four directions to confirm status or after changing a selected item.



- When you adjust to the ZOOM & FOCUS of the lens, Please remove the front cover from the camera, by turning the cover counterclockwise.
- To adjust the zoom & focus loosen the individual levers before tightening them again.
- To ensure the weatherproof integrity is maintained, Before installation the front cover, it's necessary to push tight first. and then turn it clockwise to locking indication.

## Back

---

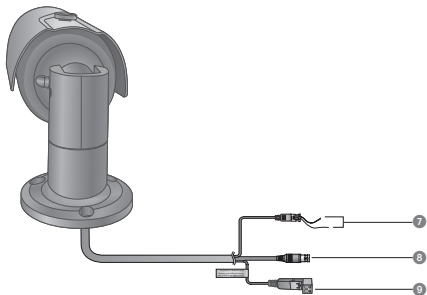

**7 Function jack**

BLUE (ALARM OUT) : Output port that signals when a motion is detected.

BLACK(GND) : Earth-grounding port for external signal.

**8 Video output jack** : Video signals are output through this port. Connect this port to the Video IN port of a AHD DVR.

**9 Power input terminal** : Connect the power as specified for each model here.

## ADJUST THE LENS'S ZOOM AND FOCUS

1. Remove the sunshield from the camera.
2. Remove the front cover from the camera by turning it counterclockwise.
3. Unlock the Zoom or Focus lever before adjusting the lens.
4. Adjust the zoom & focus by moving the lever counterclockwise for (NEAR & WIDE) and clockwise for (TELE & FAR) position.
5. After adjustment, tighten the zoom or focus levers, taking care not to adjust the zoom/focus position.
6. Please, close and tighten the front cover.
7. Replace the sunshield.

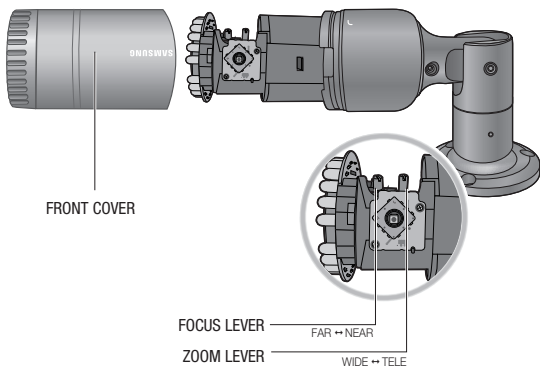

- If the front cover is cross threaded or not correctly tightened the camera housing will not be weatherproof.

## CONNECTING TO MONITOR

---

Please connect the Video output jack located on the back of the camera to the AHD DVR.

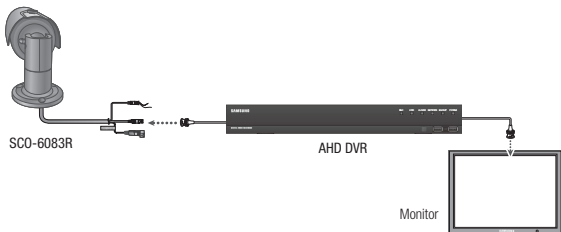

- As the connecting method varies with the instruments, refer to the manual supplied with the instrument.
- Only connect the cable when the power is turned off.

## CONNECTING TO POWER

---

You can connect power as shown in the following figure.

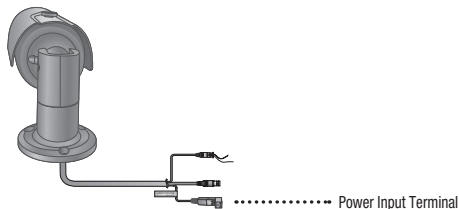

When the resistance value of copper wire is at [20°C(68°F)]

Copper wire size (AWG)	#24 (0.22mm <sup>2</sup> )	#22 (0.33mm <sup>2</sup> )	#20 (0.52mm <sup>2</sup> )	#18 (0.83mm <sup>2</sup> )
Resistance value(Ω/m)	0.078	0.050	0.030	0.018
Voltage Drop (V/m)	0.028	0.018	0.011	0.006

- As shown in the table above, voltage decreases as the wire gets longer. Therefore use of an excessively long adaptor output line for connection to the camera may affect the performance of the camera.
- ※ Standard voltage for camera operation : DC 12V±10%, AC 24V±10%
- ※ There may be some deviation in voltage drop depending on the type of wire and the manufacturer.



■ Be sure to connect power only after all the installation is complete.

## USING COAXIAL COMMUNICATIONS

- Coaxial Communications System
- OSD Control method

CAMERA	DVR
SET	MENU/ENTER
UP	UP KEY
DOWN	DOWN KEY
LEFT	LEFT KEY
RIGHT	RIGHT KEY

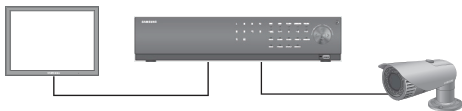

● ——— : BNC

# connection

---

## - Video Cable

The camera's video output port is connected to the DVR with a BNC coaxial cable, shown below.

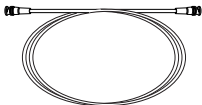

Distance	Recommended Cable Specification
500m	75-5 Coaxial Cable



- It is recommended that pure copper coax cable is used and not copper coated steel, as this will cause issues with the communication over the coaxial cable.
- To ensure picture quality, only single-channel video output connector can be used while camera connected to other video equipments.



## MENU CONFIGURATION

MAIN SETUP			
PROFILE	● BASIC ● ITS	● DAY/NIGHT ● INDOOR	● BACKLIGHT ● USER
D-WDR	● ON	● OFF	
WHITE BAL	● ATW ● MANUAL	● OUTDOOR ● AWC → SET	● INDOOR
EXPOSURE	● BRIGHTNESS ● AGC	● LENS ● SSNR4	● SHUTTER ● RETURN
BACKLIGHT	● OFF	● USER BLC	● HLC
SPECIAL	● DISPLAY ● VIDEO OUTPUT ● PRIVACY	● COMM ADJ ● DAY/NIGHT ● MOTION	● IMAGE ADJ ● DEFOG ● RETURN
EXIT	● SAVE	● NOT SAVE	● RESET

## MENU SETUP

For function setting, you can use the function setting switch inside the cover.

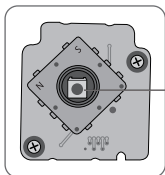

Function Setup switch

# camera operation

---

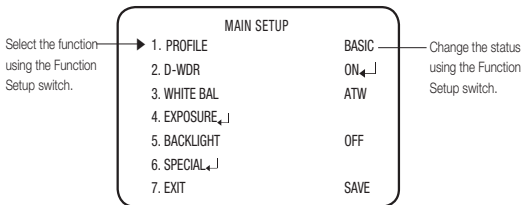

1. Press the Function Setup switch.
  - Main SETUP menu is displayed on the monitor screen.
2. Select a desired function using the Function Setup switch.
  - Place the cursor over a desired item.
3. Set up a selected item by using the Function Setup switch.
4. To finish the setting, select 'EXIT' and press the Function Setup switch.



- An item with the ← ↓ icon also has sub menus. To select a sub menu, select an item with the icon and press the Function Setup switch.
- An item with the --- icon is unavailable due to function settings.

## PROFILE

---

1. When the SETUP menu screen is displayed, select 'PROFILE' by using the Function Setup switch so that the arrow indicates 'PROFILE'.

2. Select a desired mode using the Function Setup switch according to the picture display you want.

- **BASIC** : The most common environment is set to meet.
- **DAY/NIGHT** : It will be set automatically so it optimizes to the day or night conditions, respectively.
- **BACKLIGHT** : It will be set automatically so you can distinguish the object from the background in a severe backlighting scene.
- **ITS** : It will be set automatically so you can easily check the traffic conditions.

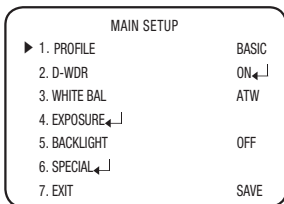

- **INDOOR** : It will be set automatically to help you take a picture in a regular indoor lighting condition.
- **USER** : Automatically configures the camera to your custom settings.
  - 1) Select Custom for Simple Setup mode.
  - 2) Configure the menu options to your custom settings.
  - 3) The settings are automatically saved as Custom mode.
  - 4) Profile user mode don't initialize when menu resets.

3. In the PROFILE menu, you can configure the following camera settings at once.

	BASIC	DAY/NIGHT	BACKLIGHT	ITS	INDOOR	USER
SHUTTER	1/5~1/12000	1/5~1/12000	1/5~1/12000	1/200~1/12000	A.FLK	-
AGC	HIGH	HIGH	HIGH	HIGH	HIGH	-
WHITE BAL	ATW	ATW	ATW	OUTDOOR	INDOOR	-
BACKLIGHT	OFF	OFF	USER BLC	OFF	OFF	-
SSNR4	ON	ON	ON	ON	ON	-
DAY/NIGHT	AUTO	AUTO	AUTO	AUTO	AUTO	-



- If you select the ITS, the shutter will be set to 1/200 sec. Noise can be detected at night.

## D-WDR

When there are both bright and dark areas at the same time, this mode makes both areas distinctive.

1. When the SETUP menu screen is displayed, select 'D-WDR' by using the Function Setup switch so that the arrow indicates 'D-WDR'.
2. Select a desired mode using the Function Setup switch.
  - **LEVEL** : Adjust the WDR Brightness by controlling the bar from 1 to 32.

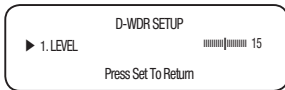

<WDR ON>



<WDR OFF>



- In D-WDR mode, there can be noise between a bright and dark area.
- Depending on light conditions, unnatural changes or symptoms can occur on the screen so deactivate the user mode.

## White Bal (White Balance)

---

Use the White Balance function to adjust the screen color.

1. When the SETUP menu screen is displayed, select 'White Bal' by using the Function Setup switch so that the arrow indicates 'White Bal' .
2. Select a desired mode using the Function Setup switch.

※ Select one of the following 5 modes, as appropriate for your purpose.

MAIN SETUP	
1. PROFILE	BASIC
2. D-WDR	ON ←
▶ 3. WHITE BAL	ATW

- **ATW** : Select this when the color temperature is between 1,800°K and 10,500°K.
- **OUTDOOR** : Use it in a color temperature range of 1,800K to 10,500K.(including Natrium). Auto adjustment is made to optimize the camera color to the outdoor environment.
- **INDOOR** : Select this when the color temperature is between 4,500°K and 8,500°K. Automatically adjusts the camera color for optimization to the indoor environment.

- **MANUAL** : Select this to fine-tune White Balance manually. Set White Balance first by using the ATW or AWC mode. After that button to MANUAL mode, fine-tune the White Balance and the Function Setup switch.

WB MANUAL	
▶ 1. RED GAIN	110
2. BLUE GAIN	138
3. RETURN ←	

- **AWC→SET** : To find the optimal luminance level for the current environment, point the camera towards a sheet of white paper and press the Function Setup switch. If the environment changes, readjust it.



- White Balance may not work properly under the following conditions. In this case select the AWC mode.
  - ① Select this When the color temperature of environment surrounding the subject is out of the control range (e.g. clear sky, or sunset)
  - ② When the ambient illumination of the subject is dim.
- If the camera is directed towards a fluorescent light or is installed in a place where illumination changes dramatically, the White Balance operation may become unstable.

## EXPOSURE

1. When the SETUP menu screen is displayed, select 'EXPOSURE' by using the Function Setup switch so that the arrow indicates 'EXPOSURE'.
2. Select a desired mode using the Function Setup switch.

- **BRIGHTNESS** : Adjusts the video brightness.

- **LENS** : Using this function, you can control the screen brightness.

- DC : Select Auto Iris Lens.

- **IRIS SPEED (DC)** : Adjusts the Iris control

speed of the DC lens. If the control speed is too slow or fast, please use this menu to adjust the speed.

- **FOCUS ADJ (DC)** : To correctly adjust the focus of LENS, activate the focus setup mode located at the bottom of each lens menu.

- Manual : The shutter does not automatically move but is fixed to the maximal degree in this mode.

- **SHUTTER** : You can select the shutter.

- MIN : 1 ~ 1/12000

- MAX : 1/60 ~ 1/12000(NTSC) , 1/50 ~ 1/12000(PAL)

- A.FLK : Select this when you experience picture flicker, this happen when there is a clash with the installed lighting frequency.

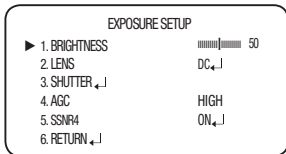

# camera operation

---



- The greater the shutter value the brighter the screen is but the more the residual images of objects there are.
- If the min shutter value is large, it can cause noise, spots and white areas but still operate normally.
- If you do not use the AGC mode on the exposure menu, it cannot be set above 1/60sec.
- Depending on the setting range of the minimal/maximal shutter, the screen exposure can become saturated.

- **AGC (OFF/LOW/MIDDLE/HIGH/VERY HIGH) :**

The higher the gain level, the brighter the screen - but the greater the noise.

- **SSNR4 :** This function reduces the background noise in a low luminance environment.

- OFF : Deactivates SSNR4. Noise is not reduced.
- ON : Activates SSNR4 so that noise is reduced.



- When adjusting the noise reduction level in the SSNR4 mode, remember that the higher the level set, the more the noise level will be reduced, as will the brightness of the image.

## BACKLIGHT

---

The camera uses our own NVP2440H chips that are designed to clearly display the object and the background despite severe reverse light.

1. When the SETUP menu screen is displayed, select 'BACKLIGHT' by using the Function Setup switch. so that the arrow indicates 'BACKLIGHT'.
2. Select a desired mode using the Function Setup switch depending on the camera purpose.

- **USER BLC :**

Enables a user to select a desired area on a picture and view that area more clearly.

- LEVEL : Adjusts the brightness level of a monitoring area.
- TOP/BOTTOM/LEFT/RIGHT : Adjust the area to be enhanced.
- RETURN : Return to the MAIN SETUP menu.

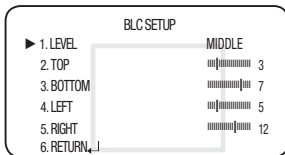

- **HLC (High Light Compensation) :**

This function masks the strong light to minimize white out due to over exposure and preserve much of the on-screen details when the camera aims a strong light source.

- LEVEL : Adjusts the brightness level of a monitoring area.
- LIMIT : Enable to change the operating condition.
- TOP/BOTTOM/LEFT/RIGHT : Adjust the area to be enhanced.
- RETURN : Return to the MAIN SETUP menu.

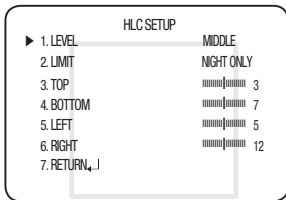

- If the white balance menu is set to manual, then HLC performance can be limited.
- If you use the defog and HLC functions at the same time, saturation can occur in a bright environment.
- Because there can be a difference in the effectiveness of HLC according to the amount of light area in the screen, optimize the installation angle for the best HLC performance.
- When dark, the HLC is only activated when a bright light exceeding a specific size. (In NIGHT ONLY mode).
- The HLC is not activated in day light or when bright light is not present at night. (In NIGHT ONLY mode).

## SPECIAL

1. When the SETUP menu screen is displayed, select 'SPECIAL' by using the Function Setup switch so that the arrow indicates 'SPECIAL'.
2. Select a desired mode using the Function Setup switch.

### • DISPLAY

- ① If the SPECIAL menu screen is displayed, use the Function Setup switch so that the arrow indicates 'DISPLAY'.
- ② Select a desired mode using the Function Setup switch.

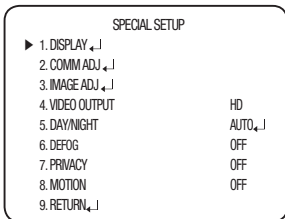

### - CAM TITLE

- ① If the DISPLAY menu screen is displayed, use the Function Setup switch so that the arrow indicates 'CAM TITLE'.
- ② Set it to 'ON' by using the Function Setup switch.
- ③ Press the Function Setup switch.
- ④ Use the Function Setup switch to move to a desired letter and select the letter by pressing the Function Setup switch. Repeat this to enter multiple letters. You can enter up to 15 letters.
- ⑤ Enter a title, move the cursor to 'POS' and press the Function Setup switch. The entered title appears on the screen. Select the position to display the title on the screen by using the Function Setup switch and press the Function Setup switch. When the position is determined, select 'END' and press the Function Setup switch to return to the DISPLAY menu.

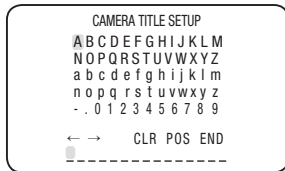

- When the CAM TITLE menu is 'OFF', no title will be displayed on the monitor screen even if you enter one.
- and Numbers are available in this mode.
- If you move the cursor to CLR and press the Function Setup switch, all the letters are deleted. To edit a letter, change the cursor to the bottom left arrow and press the Function Setup switch. Move the cursor over the letter to be edited, move the cursor to the letter to be inserted and then press the Function Setup switch.



- FONT COLOR : You can change the OSD font color. (White, Yellow, Green, Red, Blue)
- LANGUAGE : You can select the menu language according to your requirements.
- RETURN : Return to the SPECIAL menu.

● **COMM ADJ (Communication Adjustment) :**

- COAX : You can select whether to use COAX communication.
- RETURN : Return to the SPECIAL menu.



● **IMAGE ADJ**

- 1 If the SPECIAL menu screen is displayed, use the Function Setup switch so that the arrow indicates 'IMAGE ADJ'.
- 2 Select a desired mode using the Function Setup switch.

- GAMMA :  
The setting range is 0.35 ~ 1.0 .  
The closer to 1.0 the setting is, the darker it gets. default value is User, User is the optimum setting.
- PED LEVEL : The setting range is 1 ~ 100. The closer to 100 the setting is, the higher the PED level gets.
- COLOR GAIN : The setting range is 1 ~ 100. The smaller the setting value is the smaller the color gain gets and the more color blind it gets.
- H-REV : Flip an image horizontally.
- V-REV : Flip an image vertically.
- SHARPNESS : Select a mode to adjust the thickness of an image's sharpness. Depending on the image, adjust it to an appropriate value.
  - OFF : Released state
  - ON : The setting range is 1 ~ 32.
- RETURN : Return to the SPECIAL menu.

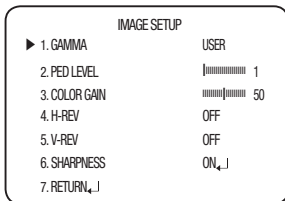

- When the V-REV or H-REV mode is enabled, the text on the screen does not flip.
- If you increase the SHARPNESS level too high, the picture may become distorted or noise may appear.

# camera operation

## • VIDEO OUTPUT

- 1 If the SPECIAL menu screen is displayed, use the Function Setup switch so that the arrow indicates 'VIDEO OUTPUT'.
- 2 Select a desired mode using the Function Setup switch.

- HD : HD Video resolution(1920X1080)
- SD : SD Video resolution



- Please exit the menu and hold the "function setup switch" for over 5 seconds, it can switch HD/SD.

## • DAY/NIGHT : You can display pictures in color or in black and white.

- 1 If the SPECIAL menu screen is displayed, use the Function Setup switch so that the arrow indicates 'DAY/NIGHT'.
- 2 Select a desired mode using the Function Setup switch according to the picture display you want.

AUTO SETUP	
▶ 1. BURST MODE	ON
2. DURATION	NORMAL
3. DWELL TIME	30 SEC
4. RETURN	J

- **AUTO** : The mode is switched to 'Color' in a normal environment, but switches to 'B/W' mode when ambient illumination is low. To set up the switching time for AUTO mode, press the Function Setup switch. You can turn on or off the burst signal on B/W mode.

- **BURST MODE** : Activate or deactivate the burst mode to maintain or remove the color signal.
- **DURATION** : This function is used to select the brightness of light where switching occurs.
- **DWELL TIME** : You can select day/night switching delay time from.  
→ 3s, 5s, 7s, 10s, 15s, 20s, 30s, 40s, 60s



- If you set the AGC mode to off on the exposure menu, you cannot switch the day/night mode to auto.
- When a bright light source is in the screen or there are frequent brightness changes, if you use the auto night/day mode, and set the switching time to short (3, 5 sec), a hunting can be caused. In this situation, it is recommended to use the default setting (30 sec).
- **COLOR** : The picture is always displayed in color.
- **B/W** : The picture is always displayed in black and white.
  - **BURST MODE** : Activate or deactivate the burst mode to maintain or remove the color signal.
  - **IR MODE** : When IR LED is turned on in B/W, the objects can be clearly identified due to the function that decreases screen saturation of objects within a short distance.

- **DEFOG** : You can use the defog mode to allow the camera to automatically detect the fog density of the screen and display a clear image despite smog, fog or general poor visibility.

- 1 If the SPECIAL menu screen is displayed, use the Function Setup switch so that the arrow indicates 'DEFOG'.

DEFOG	
▶ 1. LEVEL	MIDDLE
2. RETURN	

- 2 Select a desired mode using the Function Setup switch.

- AUTO : Adjust the level automatically.
- Manual : Depending on the defog level set by the user, adjust the clarity of image. (LOW, MIDDLE, HIGH)
- OFF : Released state



- If the defog mode is set to Auto, and if the amount of fog is reduced, the function level will be also reduced. If you want to maintain the same level of defogging, set it to Manual.
- If there is little fog and the manual fog level is high, the screen contrast can get high.

- **PRIVACY** : Mask an area you want to hide on the screen.

- 1 If the SPECIAL menu screen is displayed, use the Function Setup switch so that the arrow indicates 'PRIVACY'.

PRIVACY AREA SETUP	
▶ 1. AREA	AREA1
2. MODE	OFF
3. MASK COLOR	GREEN
4. TRANSPARENCY	OFF
5. TOP	10
6. BOTTOM	50
7. LEFT	10
8. RIGHT	40
9. RETURN	

- 2 Select a desired mode using the Function Setup switch.

- AREA : You can select up to 4 PRIVACY areas.
- MODE : Determines whether to use the area selected in the AREA.
- MASK COLOR : Determine area color. You can select Green, Red, Blue, Black, White, Gray.
- TRANSPARENCY : Adds or removes transparency from the masking area.
- TOP / BOTTOM / LEFT / RIGHT : Adjust the size and position of the selected area.
- RETURN : Return to the SPECIAL menu.

# camera operation

---

- **MOTION** : This product generates signals each time an object movement is detected in the four areas of the screen so efficient monitoring can be achieved.

① If the SPECIAL menu screen is displayed, use the Function Setup switch so that the arrow indicates 'MOTION'.

② Select a desired mode using the Function Setup switch.

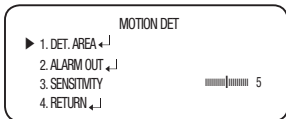

- DET.AREA : Set the areas of motion detection.
  - SEL AREA : Select from four areas that users want.
  - MODE : Determine whether to use the selected area.
  - TRANSPARENCY : Adds or removes transparency from the masking area.
  - TOP/BOTTOM/LEFT/RIGHT : Area location can be adjusted.
  - RETURN : Return to the MOTION DET menu.
- ALARM OUT : When object movement is detected, the detection signal will be outputted.
  - EXTERNAL : Send signals through external terminals.
  - OSD : Display signals on the screen.
  - RETURN : Return to the MOTION DET menu.
- SENSITIVITY : Set the sensitivity of the motion detection. When you adjust the higher level, the more sensitive.
- RETURN : Return to the SPECIAL menu.

## EXIT

---

Select a desired EXIT mode using the Function Setup switch depending on the camera purpose.

- **SAVE** : Save the current settings and exit the MAIN SETUP menu.
- **NOT SAVE** : Do not save the current settings and exit the MAIN SETUP menu.
- **RESET** : Revert camera to factory settings. (The language, communication and lens settings will remain the same).

## TROUBLESHOOTING

If you have trouble operating your camera, refer to the following table.

If the guidelines do not enable you to solve the problem, contact an authorized technician.

Problems	Troubleshooting
Nothing appears on the screen.	<ul style="list-style-type: none"><li>• Check that the power cord and line connection between the camera and monitor are properly connected.</li><li>• Check that you have properly connected BNC cable to the camera.</li><li>• Check the type of lens.</li></ul>
The image on the screen is dim.	<ul style="list-style-type: none"><li>• Is lens stained with dirt? Clean your lens with soft, clean cloth.</li><li>• Set the monitor or DVR to the proper condition.</li><li>• If the camera is exposed to very strong light, change the camera position.</li></ul>
The image on the screen is dark.	<ul style="list-style-type: none"><li>• Adjust the contrast feature of the monitor or DVR.</li><li>• If you have an intermediate device, set the 75Ω / Hi-z properly.</li></ul>
The camera is not working properly, and the surface of the camera is hot.	<ul style="list-style-type: none"><li>• Check that you have properly connected the camera to an appropriate power source.</li></ul>
he DAY/NIGHT menu does not work.	<ul style="list-style-type: none"><li>• Check that AGC of EXPOSURE SETUP menu is 'OFF'.</li></ul>
Color is not correct.	<ul style="list-style-type: none"><li>• Check the setting of WHITE BAL SETUP menu</li></ul>
The screen flickers continually.	<ul style="list-style-type: none"><li>• Ensure the camera is not pointing towards the sun.</li></ul>

## SPECIFICATIONS

	SCO-6083RN	SCO-6083RP
<b>Video</b>		
Imaging Device	1/2.9" 2M CMOS	
Total Pixels	2,000(H) x 1,121(V) 2.24M pixels	
Effective Pixels	1,984(H) x 1,105(V) 2.19M pixels	
Scanning System	Progressive Scan	
Horizontal Resolution	1000TVL	
Min. Illumination	Color : 0.2Lux (F1.4, 50IRE); 0.11Lux (F1.4, 30IRE) B/W : 0Lux(IR LED on)	
S / N Ratio	52dB (AGC off, Weight on)	
Video Output	BNC(AHD, CVBS Selectable)	
Resolution	1920 x 1080	
Max. Framerate	30fps @1080p, 30fps@ 720p	
<b>Lens Type</b>		
Focal Length (Zoom Ratio)	2.8 ~ 12mm (4.3x) varifocal	
Max. Aperture Ratio	F1.4	
Angular Field of View	H : 103.8°(Wide) ~ 32.4°(Tele) / V : 53.7°(Wide) ~ 18.4°(Tele) D : 121.9°(Wide) ~ 37.1°(Tele)	
Min. Object Distance	0.5m (1.64ft)	
Focus Control	Manual	
Lens Type	DC Auto Iris	
Mount Type	Board-in type	
<b>Operational</b>		
On Screen Display	Multi-language Support(16) English, Japanese, Spanish, French, Portuguese, Korean, German, Italian, Russian, Polish, Czech, Romanian, Serbian, Swedish, Danish, Turkish	
Camera Title	Off / On (Displayed 15 characters)	
Day & Night	Auto (ICR) / Color / B/W	
Backlight Compensation	Off / User BLC / HLC	
Wide Dynamic Range	D-WDR	
Digital Noise Reduction	SSNR4 ( Off / On )	

	SCO-6083RN	SCO-6083RP
Defog	AUTO / MANUAL / OFF	
Motion Detection	Off / On(4 zones)	
Privacy Masking	Off / On (4 zones rectangle)	
Gain Control	Off / Low / Middle / High / Very High	
White Balance	ATW / Outdoor / Indoor / Manual / AWC(1,800K° ~ 10,500K°)	
Electronic Shutter Speed	1 sec ~ 1/12,000 sec	
Reverse	Off / H-Rev / V-Rev / HV-Rev	
Profile	Basic, Day & Night, Backlight, ITS, Indoor, User	
Alarm	MD output 1	
Remote control interface	Coaxial	
Protocol	Coax : ACP	
IR Distance	30m(98.43ft)	
Video Transmission Distance	500m(75-5 Coaxial Cable)	
<b>Environmental</b>		
Operating Temperature / Humidity	-30°C ~ +55°C (-22°F ~ +131°F) / Less than 90% RH * Start up should be done at above -10°	
Ingress Protection	IP66	
Vandal Resistance	IK10	
<b>Electrical</b>		
Input Voltage	Dual ( 24VAC±10% & 12VDC±10% )	
Power Consumption	Max. 6W	
<b>Mechanical</b>		
Color / Material	Dark Gray / Aluminum	
Dimension (HxØ)	260 mm x Ø 78 mm	
Weight	887g	922g

※ The specification for this product may change without prior notice for product improvement.

## DIMENSION

Unit: mm(inch)

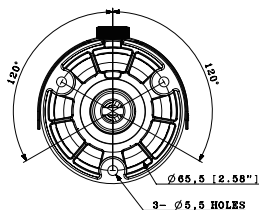
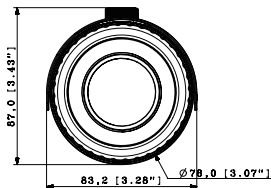
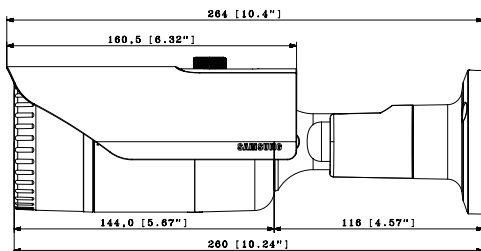



# MEMO



## SALES NETWORK

---

### HEAD OFFICE

6, Pangyo-ro 319beon-gil, Bundang-gu, Seongnam-si, Gyeonggi-do, SEOUL 463-400 Rep. of KOREA

Tel : +82-70-7147-8753, 8764 Fax : +82-31-8018-3740

[www.samsungsecurity.com](http://www.samsungsecurity.com)

### SAMSUNG TECHWIN AMERICA Inc.

100 Challenger Rd. Suite 700 Ridgfield Park, NJ 07660

Toll Free : +1-877-213-1222 Direct : +1-201-325-6920

Fax : +1-201-373-0124

[www.samsung-security.com](http://www.samsung-security.com)

### SAMSUNG TECHWIN EUROPE LTD.

2nd Floor, No. 5 The Heights, Brooklands, Weybridge, Surrey,

KT13 0NY, UK

Tel : +44-1932-82-6700 Fax : +44-1932-82-6701

[www.samsungsecurity.co.uk](http://www.samsungsecurity.co.uk)

---