

---

**SAMSUNG TECHWIN**

# **High Resolution Day/Night IR Dome Camera**

User Manual

SCD-2080R

---



**CE**



# High Resolution Day/Night IR Dome Camera

## User Manual

---

### Copyright

©2010 Samsung Techwin Co., Ltd. All rights reserved.

### Trademark

 is the registered logo of Samsung Techwin Co., Ltd.  
The name of this product is the registered trademark of Samsung Techwin Co., Ltd.  
Other trademarks mentioned in this manual are the registered trademark of their respective company.

### Restriction

Samsung Techwin Co., Ltd shall reserve the copyright of this document. Under no circumstances, this document shall be reproduced, distributed or changed, partially or wholly, without formal authorization of Samsung Techwin.

### Disclaimer

Samsung Techwin makes the best to verify the integrity and correctness of the contents in this document, but no formal guarantee shall be provided. Use of this document and the subsequent results shall be entirely on the user's own responsibility. Samsung Techwin reserves the right to change the contents of this document without prior notice.

### Warranty

If the product does not operate properly in normal conditions, please let us know. Samsung Techwin will resolve the problem for free of charge. The warranty period is 3 years. However, the followings are excluded:

- If the system behaves abnormally because you run a program irrelevant to the system operation.
- Deteriorated performance or natural worn-out in process of time

Before operating the camera, confirm the camera model and correct input power voltage.  
To help you understand this manual thoroughly, we'll introduce our model description.

■ SCD-2080R SERIES

- NTSC MODEL  
SCD-2080RN
- PAL MODEL  
SCD-2080RP

■ MODEL DESCRIPTION

- SCD-2080RX



- SIGNAL SYSTEM  
N → NTSC MODEL  
P → PAL MODEL

## safety information



**CAUTION**  
RISK OF ELECTRIC SHOCK.  
DO NOT OPEN



**CAUTION:** TO REDUCE THE RISK OF ELECTRIC SHOCK, DO NOT REMOVE COVER (OR BACK) NO USER SERVICEABLE PARTS INSIDE. REFER SERVICING TO QUALIFIED SERVICE PERSONNEL.



This symbol indicates that dangerous voltage consisting a risk of electric shock is present within this unit.



This exclamation point symbol is intended to alert the user to the presence of important operating and maintenance (servicing) instructions in the literature accompanying the appliance.

### WARNING

- To prevent damage which may result in fire or electric shock hazard, do not expose this appliance to rain or moisture.
- To prevent injury, this apparatus must be securely attached to the floor/wall in accordance with the installation instructions.

### WARNING

1. Be sure to use only the standard adapter that is specified in the specification sheet. Using any other adapter could cause fire, electrical shock, or damage to the product.
2. Incorrectly connecting the power supply or replacing battery may cause explosion, fire, electric shock, or damage to the product.
3. Do not connect multiple cameras to a single adapter. Exceeding the capacity may cause abnormal heat generation or fire.
4. Securely plug the power cord into the power receptacle. insecure connection may cause fire.
5. When installing the camera, fasten it securely and firmly. The fall of camera may cause personal injury.

6. Do not place conductive objects (e.g. screwdrivers, coins, metal parts, etc.) or containers filled with water on top of the camera. doing so may cause personal injury due to fire, electric shock, or falling objects.
7. Do not install the unit in humid, dusty, or sooty locations. doing so may cause fire or electric shock.
8. If any unusual smells or smoke come from the unit, stop using the product. in such case, immediately disconnect the power source and contact the service center. continued use in such a condition may cause fire or electric shock.
9. If this product fails to operate normally, contact the nearest service center. never disassemble or modify this product in any way. (samsung is not liable for problems caused by unauthorized modifications or attempted repair.)
10. When cleaning, do not spray water directly onto parts of the product. doing so may cause fire or electric shock.

## CAUTION

1. Do not drop objects on the product or apply strong shock to it. Keep away from a location subject to excessive vibration or magnetic interference.
2. Do not install in a location subject to high temperature (over 50°C), low temperature (below -10°C), or high humidity. Doing so may cause fire or electric shock.
3. If you want to relocate the already installed product, be sure to turn off the power and then move or reinstall it.
4. Remove the power plug from the outlet when there is a lightning. Neglecting to do so may cause fire or damage to the product.
5. Keep out of direct sunlight and heat radiation sources. It may cause fire.
6. Install it in a place with good ventilation.
7. Avoid aiming the camera directly towards extremely bright objects such as sun, as this may damage the CCD image sensor.
8. Apparatus shall not be exposed to dripping or splashing and no objects filled with liquids, such as vases, shall be placed on the apparatus.
9. The Mains plug is used as a disconnect device and shall stay readily operable at any time.
10. Do not expose the camera to radioactivity. Radioactivity exposure may damage the CCD.

# safety information

## FCC STATEMENT

This device complies with part 15 of the FCC Rules. Operation is subject to the following two conditions :

- 1) This device may not cause harmful interference, and
- 2) This device must accept any interference received including interference that may cause undesired operation.

## CAUTION

This equipment has been tested and found to comply with the limits for a Class A digital device, pursuant to part 15 of FCC Rules. These limits are designed to provide reasonable protection against harmful interference when the equipment is operated in a commercial environment.

This equipment generates, uses, and can radiate radio frequency energy and, if not installed and used in accordance with the instruction manual, may cause harmful interference to radio communications. Operation of this equipment in a residential area is likely to cause harmful interference in which case the user will be required to correct the interference at his own expense.



### IC Compliance Notice

This Class A digital apparatus meets all requirements of the Canadian Interference.-Causing Equipment Regulations of ICES-003.



### Correct Disposal of This Product (Waste Electrical & Electronic Equipment)

(Applicable in the European Union and other European countries with separate collection systems)

This marking on the product, accessories or literature indicates that the product and its electronic accessories (e.g. charger, headset, USB cable) should not be disposed of with other household waste at the end of their working life. To prevent possible harm to the environment or human health from uncontrolled waste disposal, please separate these items from other types of waste and recycle them responsibly to promote the sustainable reuse of material resources.

Household users should contact either the retailer where they purchased this product, or their local government office, for details of where and how they can take these items for environmentally safe recycling.

Business users should contact their supplier and check the terms and conditions of the purchase contract. This product and its electronic accessories should not be mixed with other commercial wastes for disposal.



### Correct disposal of batteries in this product

(Applicable in the European Union and other European countries with separate battery return systems.)

This marking on the battery, manual or packaging indicates that the batteries in this product should not be disposed of with other household waste at the end of their working life. Where marked, the chemical symbols Hg, Cd or Pb indicate that the battery contains mercury, cadmium or lead above the reference levels in EC Directive 2006/66. If batteries are not properly disposed of, these substances can cause harm to human health or the environment.

To protect natural resources and to promote material reuse, please separate batteries from other types of waste and recycle them through your local, free battery return system.

# important safety instructions

1. Read these instructions.
2. Keep these instructions.
3. Heed all warnings.
4. Follow all instructions.
5. Do not use this apparatus near water.
6. Clean only with dry cloth.
7. Do not block any ventilation openings. Install in accordance with the manufacturer's instructions.
8. Do not install near any heat sources such as radiators, heat registers, or other apparatus (including amplifiers) that produce heat.
9. Do not defeat the safety purpose of the polarized or grounding-type plug. A polarized plug has two blades with one wider than the other. A grounding type plug has two blades and a third grounding prong. The wide blade or the third prong is provided for your safety. If the provided plug does not fit into your outlet, consult an electrician for replacement of the obsolete outlet.
10. Protect the power cord from being walked on or pinched particularly at plugs, convenience receptacles, and the point where they exit from the apparatus.
11. Only use attachments/accessories specified by the manufacturer.
12. Use only with cart, stand, tripod, bracket, or table specified by the manufacturer, or sold with the apparatus.
13. Unplug this apparatus when a card is used. Use caution when moving the cart/ apparatus combination to avoid injury from tip-over.
14. Refer all servicing to qualified service personnel. Servicing is required when the apparatus has been damaged in any way, such as powersupply cord or plug is damaged, liquid has been spilled or objects have fallen into the apparatus, the apparatus has been exposed to rain or moisture, does not operate normally, or has been dropped.



Apparatus shall not be exposed to dripping or splashing and no objects filled with liquids, such as vases, shall be placed on the apparatus



Samsung Techwin cares for the environment at all product manufacturing stages to preserve the environment, and is taking a number of steps to provide customers with more environment-friendly products. The Eco mark represents Samsung Techwin's will to create environment-friendly products, and indicates that the product satisfies the EU RoHS Directive.

# contents

---

<b>INTRODUCTION</b>	<b>9</b>	Features
	<b>10</b>	What's included
	<b>11</b>	Component names and Functions
<b>9</b>		
<b>INSTALLATION</b>	<b>12</b>	Installation
	<b>15</b>	Adjust the panning and tilting while watching the monitor
<b>12</b>		
<b>CONNECTION</b>	<b>16</b>	Connecting to Monitor
	<b>16</b>	Connecting to Power
	<b>17</b>	Using Coaxial Communications
<b>16</b>		
<b>SETUP</b>	<b>18</b>	Menu Configuration
	<b>18</b>	Menu Setup
<b>18</b>		
<b>TROUBLESHOOTING</b>	<b>31</b>	Troubleshooting
<b>31</b>		
<b>SPECIFICATIONS</b>	<b>32</b>	Specifications
	<b>34</b>	Dimension
<b>32</b>		



## FEATURES

---

- **Ultra High Resolution**

By adopting a diagonal 6mm(1/3") 410,000 (NTSC) pixels, 470,000(PAL) pixels SONY CCD, the camera produces clear picture quality with a horizontal resolution of 600 TV lines for color and 700 TV lines for BW

- **Excellent Sensitivity**

The Built-in high sensitivity COLOR CCD enables a clear image even in 0Lux(B/W,IR-LED ON) or lower illumination,

- **SSNR3 (Samsung Super Noise Reduction) Function**

The high-performance W-V DSP chip effectively removes low-light gain noise and afterimage to provide clear images even in dark environments.

- **Day & Night (ICR)**

This camera has a function that automatically selects the mode that is appropriate for daytime or night-time conditions.

The COLOR mode operates in daytime conditions to provide optimum colors, and B/W mode operates in night-time conditions to enhance the definition of the image.

- **IR MODE Function**

The intensity of the IR-LEDs automatically adjust depending upon the closeness of the object to prevent saturation.

- **Indoor Visibility range 20M**

In B/W mode, the IR-LEDs are illuminated, the indoor visibility range at 0 Lux is 20M

- **SSDR (Samsung Super Dynamic Range)**

For images with high contrast between bright and dark areas from difficult lighting conditions such as backlighting, this camera selectively illuminates darker areas while retaining the same light level for brighter areas to even out the overall brightness.

- **DIS (Digital Image Stabilizer)**

The DIS function compensates for any camera movement, to produce more stable pictures.

- **Communication**

Coaxial communication methods are supported.

- Protocol : Pelco Coaxitron

# introduction

- **Miscellaneous Functions**

HLC(High Light Compensation), SENS-UP, H/V-REV, D-ZOOM, SHARPNESS, MOTION DETECTION and PRIVACY functions are provided.





- **OSD**

The camera control is convenient by using 18 different foreign language O.S.D.

- NTSC : English, French, Spanish, Japanese, Korean, Portuguese, Taiwanese
- PAL : English, French, German, Spanish, Italian, Chinese, Czech, Danish, Polish, Portuguese, Russian, Romanian, Serbian, Swedish, Turkish

## WHAT'S INCLUDED

Check if the following items are included in the product package.

		
SCD-2080R	User Manual	Quick Set-up Guide
		
M4 Tapping Screw 3EA	Installation Video Output Cable	

## COMPONENT NAMES AND FUNCTIONS

### FRONT

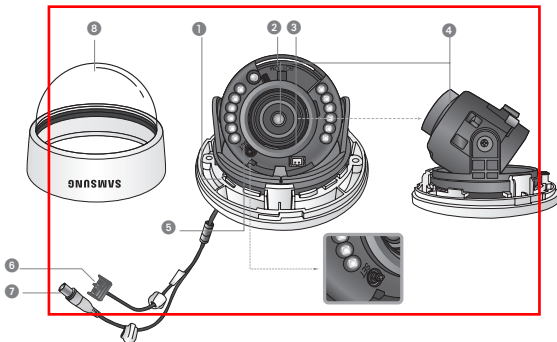

- ① **Pan Base** : control panning angle of camera
- ② **Tilt Base** : control tilting angle of camera
- ③ **Video Output Terminal to Monitor**
- ④ **x3.6 Vari-focal Lens Module 2.8 ~ 10.0mm (F1.2)**
- ⑤ **Function Setup switch** : Display the menu on the screen and move the cursor to four directions to confirm status or after changing a selected item.
- ⑥ **Power Input Terminal**
- ⑦ **Video Output Jack**
- ⑧ **Dome Cover**

# installation

## INSTALLATION

1. Separate the dome cover by turning anti-clockwise.
2. Separate the shield case by pulling from the camera body.

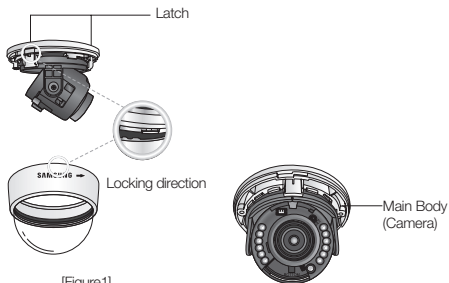

[Figure1]

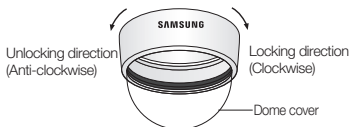

※ To install the dome cover on the camera body, turn the latches in the locking direction as shown in the figure 1.



- The installation should be done by qualified service personnel or system installers.
- If the ceiling material is not strong enough to hold the installation screws, the camera may fall off. Reinforce the ceiling as needed.
- To change the position of the cable, take away the Hole Cover and pass the cable through.

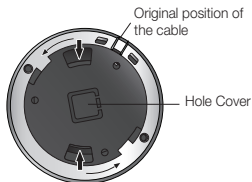

## WHEN USING THE CEILING BRACKET

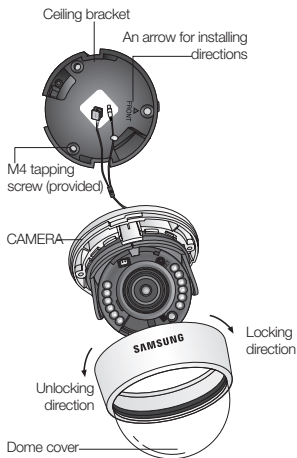

1. Hold the ceiling bracket (located where the arrow points to) and separate it from the main body of the camera by rotating it anti-clockwise. (refer to the picture in 'Notes' on page 12)
2. Place the separated ceiling bracket so that the "Front" side faces the area to be monitored and install it with the M4 tapping screws.
3. To combine the main body with the ceiling bracket, make sure that the pan base fixation screw face the opposite side of the "Front" side of the ceiling bracket and rotate it clockwise.
4. Adjust the camera lens to face the area to be monitored and fix the main body and the dome cover by aligning the grooves and rotating the body clockwise.

# installation

---

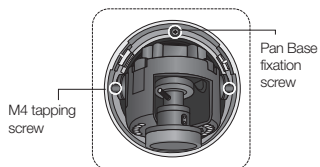

[Figure-2]



- If you want to install the camera with the ceiling bracket combined, fix it using two M4 tapping screws at the side of the main body (refer to the [Figure-2] on page 14)

## ADJUST THE PANNING AND TILTING WHILE WATCHING THE MONITOR

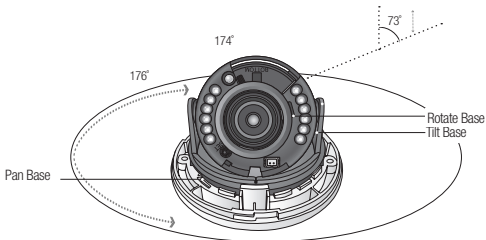

1. You can adjust the camera to point in any direction by using the pan, Tilt mechanism.
  - Pan Base can rotate by  $\pm 176^\circ$  (total  $352^\circ$ )
  - Tilt Base covers  $73^\circ$  angle.
  - Rotate Base moves by  $174^\circ$  to each side direction and  $348^\circ$  on the whole.

### 2. Methods of adjustment

- When installing on a wall
  - ① After mounting the camera on a wall, adjust the panning angle so that the correct viewing angle is attained and the titling is correctly orientated.
  - ② And then adjust the tilting angle by rotating the tilt base.
  - ③ Loosen the rotate base hold screw and adjust rotate base for the best view.
  - ④ Tighten pan and tilt securing screw.
- When installing on a ceiling
  - ① After mounting the camera on a ceiling, adjust the panning angle so that the correct viewing angle is attained and the titling is correctly orientated.
  - ② And then adjust the tilting angle by rotating the tilt base.
  - ③ Loosen the rotate base hold screw and adjust rotate base for the best view.
  - ④ Tighten pan and tilt securing screw.



- When you want to adjust the Pan/Tilt Base, loosen, adjust and then tighten the Pan/Tilt Base screws.

# connection

## CONNECTING TO MONITOR

Connect the VIDEO-OUT jack to the VIDEO-IN jack of monitor.

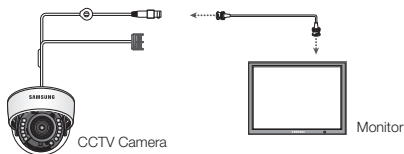

- As the connecting method varies with the instruments, refer to the manual supplied with the instrument.
- Only connect the cable when the power is turned off.

## CONNECTING TO POWER

Connect the adaptor to the power input connector as shown in the figure below.  
The recommended adaptor specification for SCD-2080RN/SCD-2080RP is DC 12V / 500mA.

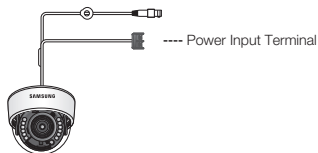

When the resistance value of copper wire is at [20°C(68°F)]

Copper wire size (AWG)	#24 (0.22mm <sup>2</sup> )	#22 (0.33mm <sup>2</sup> )	#20 (0.52mm <sup>2</sup> )	#18 (0.83mm <sup>2</sup> )
Resistance (Ω/m)	0.078	0.050	0.030	0.018
Voltage Drop (V/m)	0.028	0.018	0.011	0.006

- As shown in the table above, voltage decreases as the wire gets longer. Therefore, the use of an excessively long power cable to the camera may affect the camera's performance.



- \* Standard voltage for camera operation : DC 12V ± 10%
- \* There may be some deviation in voltage drop depending on the type of wire and the manufacturer.

- ⚠ Be sure to connect power only after all the installation is complete.
- Ground should be connected to the GND terminal.

## USING COAXIAL COMMUNICATIONS

- Coaxial Communications System
- OSD Control method

CAMERA	DVR	CONTROLLER
SET	MENU/ENTER	OSD KEY
UP	UP KEY	JOYSTICK UP
DOWN	DOWN KEY	JOYSTICK DOWN
LEFT	LEFT KEY	JOYSTICK LEFT
RIGHT	RIGHT KEY	JOYSTICK RIGHT

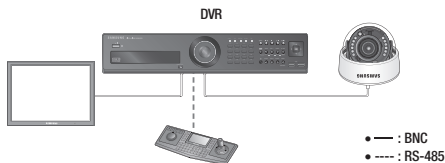

### - Video Cable

The camera's video output port is connected to the monitor with a BNC coaxial cable, shown below : If the distance between the camera and the monitor exceeds the recommended maximum, please use an auxiliary video amp.

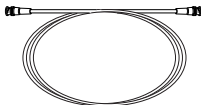

Distance	Recommended Cable Specification
300m	3C2V(RG-59/U)
450m	5C2V(RG-6/U)
600m	7C2V(RG-11/U)

- ⚠ ■ If the camera is controlled through coaxial communication, please use a video amp intended for coaxial communications. Regular video amps do not transfer coaxial signals.

## MENU CONFIGURATION

Setup Menu			
LENS	● DC		
EXPOSURE	● BRIGHTNESS ● SENS-UP	● SHUTTER ● RETURN	● AGC
WHITE BALANCE	● ATW ● MANUAL	● OUTDOOR ● AWC → SET	● INDOOR
SSDR	● OFF	● ON	
BACKLIGHT	● OFF	● BLC	● HLC
SSNR3	● OFF	● ON	
DAY/NIGHT	● AUTO	● COLOR	● B/W
SPECIAL	● IMAGE ADJ ● MOTION DET ● LANGUAGE	● MONITOR ● PRIVACY ● RETURN	● CAM TITLE ● DIS
EXIT	● SAVE	● NOT SAVE	● RESET

## MENU SETUP

Use the Function Setup switch beside of the lens.

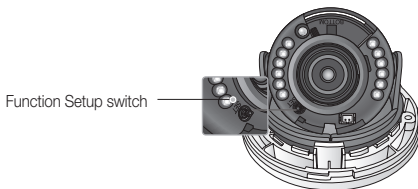

1. Press the Function Setup switch.
  - Main setup menu is displayed on the monitor screen.

Select the function by moving up or down direction of function setup switch.

MAIN SETUP		
▶ 1.LENS		DC◀↵
2.EXPOSURE◀↵		
3.WHITE BAL		ATW
4.SSDR		OFF
5.BACKLIGHT		OFF
6.SSNR3		ON◀↵
7.DAY/NIGHT		AUTO◀↵
8.SPECIAL◀↵		
9.EXIT		SAVE

Change the status by moving the setup switch left or right.

- Select a desired function using the Function Setup switch.
  - Place the cursor over a desired item.
- Set up a selected item by using the Function Setup switch.
- To finish the setting, select 'EXIT' and press the Function Setup switch.



- An item with the ◀↵ icon also has sub menus. To select a sub menu, select an item with the icon and press the Function Setup switch.
- An item with the - - - icon is unavailable due to function settings.

## LENS

Using this function, you can control the screen brightness.

- When the SETUP menu screen is displayed, select 'LENS' by using the Function Setup switch so that the arrow indicates 'LENS'.
- The Lens mode has sub menu site as listed below.

MAIN SETUP		
▶ 1.LENS		DC◀↵
2.EXPOSURE◀↵		

- BRIGHTNESS** : Adjusts the video brightness.
- FOCUS ADJ** : To adjust the lens focus correctly, you must activate the Focus Settings mode. To activate the Focus Settings mode, adjust the lens focus, and then deactivate the settings mode.
- You can adjust the shutter value of ESC shutter mode.

## EXPOSURE

- When the SETUP menu screen is displayed, select EXPOSURE by using the Function Setup switch so that the arrow indicates 'EXPOSURE'.

MAIN SETUP		
1.LENS		DC◀↵
▶ 2.EXPOSURE◀↵		
3.WHITE BAL		ATW

## setup

2. Select a desired mode using the Function Setup switch.

- **BRIGHTNESS** : Adjusts the video brightness.
- **SHUTTER** : You can select either auto or manual shutter.
  - **A.FLK** : Select this when you experience picture flicker, which can happen when there is a clash with the frequency of the installed lighting.
  - **ESC** : Select this to control the shutter speed automatically. If ESC is selected, the shutter speed is automatically controlled depending on the ambient illumination of the subject.
  - **MANUAL** : You can control shutter speed manually.  
(NTSC MODEL : 1/60~1/120,000, PAL MODEL : 1/50~1/120,000)
  - --- : Shutter speed is fixed at 1/60sec(1/50sec).

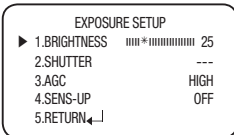

- Set the shutter mode to --- if color rolling occurs.
- When the SHUTTER is set to MANUAL or A.FLK mode, SENS-UP will be disabled.

- **AGC (AUTO GAIN CONTROL)** :

The higher the gain level, the brighter the screen but the higher the noise.

- **OFF** : Deactivates the AGC function.
  - **LOW** : Allows automatic gain control from 5.3dB to 32dB.
  - **HIGH** : Allows automatic gain control from 5.3dB to 37dB.
- **SENS-UP** : When it is night or dark, the camera automatically detects the light level and maintains a clear picture if this mode is activated.
    - **OFF** : Deactivates the SENS-UP function.
    - **AUTO** : Activates the SENS-UP function.

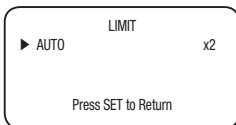

- If you press the Function Setup switch in 'AUTO' mode, You can adjust brightness by adjusting the SENS-UP level. (x2 ~ x512)
- Note that the higher the SENS-UP level, the brighter the screen, but the more likely it is that an after-image will appear.
- Although Noise, Spots, and Whitish symptoms may occur in SENS-UP operation when the sens-up level is increased, this is normal.
- If GAIN of EXPOSURE is not in use, the SENS-UP is set to "---".

## WHITE BAL (WHITE BALANCE)

Use the White Balance function to adjust the screen color.

1. When the SETUP menu screen is displayed, select 'White Bal' by using the Function Setup switch so that the arrow indicates 'White Bal'.
2. Select a desired mode using the Function Setup switch.

MAIN SETUP		
1.LENS		DC←↓
2.EXPOSURE	←↓	
▶ 3.WHITE BAL		ATW
4.SSDR		OFF

※ Select one of the following 5 modes, as appropriate for your purpose.

- **ATW** : Select this when the color temperature is between 1,700°K and 11,000°K.
- **OUTDOOR** : Select this when the color temperature is between 1,700°K and 11,000°K.(sodium light inclusion)  
Select this when the color temperature of environment surrounding the subject is out of the control range (e.g. clear sky, or sunset).
- **INDOOR** : Select this when the color temperature is between 4,500°K and 8,500°K.

- **MANUAL** : Select this to fine-tune White Balance manually. Set White Balance first by using the ATW or AWC mode. After that switch to MANUAL mode, fine-tune the White Balance and then press the Function Setup switch.

WB MANUAL		
▶ RGAIN	■■■■■■■■*■■■■■■■■	529
BGAIN	■■■■■■■■*■■■■■■■■	532
Press SET to Return		

- **AWC→SET** : To find the optimal luminance level for the current environment, point the camera towards a sheet of white paper and press the Function Setup switch. If the environment changes, readjust it.



- White Balance may not work properly under the following conditions.

- ① When the ambient illumination of the subject is dim.
- ② If the camera is directed towards a fluorescent light or is installed in a place where illumination changes dramatically, the White Balance operation may become unstable.

## SSDR (SAMSUNG SUPER DYNAMIC RANGE)

SSDR illuminates darker areas of an image while retaining the same light level for brighter areas to even out the overall brightness of images with high contrast between bright and dark areas.

1. When the SETUP menu screen is displayed, select 'SSDR' by using the Function Setup switch so that the arrow indicates 'SSDR'.
2. Use the Function Setup switch to change the SSDR level in the sub menu according to the contrast between bright and dark areas.

MAIN SETUP	
1.LENS	DC◀▶
2.EXPOSURE◀▶	
3.WHITE BAL	ATW
▶ 4.SSDR	OFF
5.BACKLIGHT	OFF

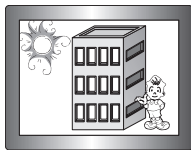

SSDR ON

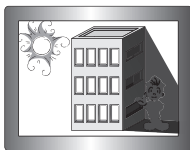

SSDR OFF

## BACKLIGHT

The SCD-2080R is designed so that it delivers a distinctive subject and background at the same time, even when the subject is in backlight, by adopting a function of the proprietary W-V DSP chip.

1. When the SETUP menu screen is displayed, select 'BACKLIGHT' by using the Function Setup switch so that the arrow indicates BACKLIGHT .
2. Select a desired mode using the Function Setup switch depending on the camera purpose.

MAIN SETUP	
1. LENS	DC◀▶
2. EXPOSURE◀▶	
3. WHITE BAL	ATW
4. SSDR	OFF
▶ 5. BACKLIGHT	OFF
6. SSNR3	ON◀▶

- **BLC** : Enables a user to directly select a desired area from a picture, and to view the area more clearly.
  - LEVEL : Adjust level of the BLC function.
  - TOP/BOTTOM/LEFT/RIGHT : Adjust the area to be enhanced.
- **HLC (High Light Compensation)** :  
 This function masks the strong light to minimize white out due to over exposure and preserve much of the on-screen details when the camera aims a strong light source.
  - LEVEL : Adjust level of the HLC function.
  - LIMIT : Enable to change the operating condition.
  - MASK COLOR/TONE :  
 Change the color / brightness of the masking area. (Black, Red, Blue, Cyan, Magenta)
  - TOP/BOTTOM/LEFT/RIGHT :  
 Adjust the area to be enhanced.
- **OFF** : Not being used

3. Select a desired mode using the Function Setup switch and press the switch.

Select 'BLC' to adjust the area to be enhanced then adjust the level.

HLC : Enable the user to change the level, limit, mask color/tone and area.

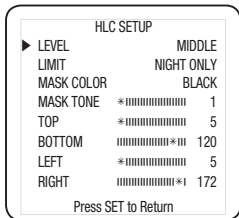
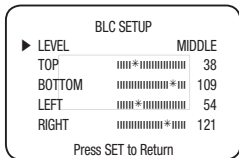

- Because there can be a difference in the effectiveness of HLC according to the amount of light area in the screen, optimize the installation angle for the best HLC performance.
- In a dark environment, the HLC is only activated when a high light that is larger than a certain area is present.
- The HLC is not activated in overly bright or dark condition. (In NIGHT ONLY mode.)
- When HLC Function is used, D-ZOOM and DIS function are not activated.
- BLC function does not work in B/W mode.





- **COLOR** : The picture is always displayed in color.
- **B/W** : The picture is always displayed in black and white.  
You can turn on or off the burst signal on B/W mode.

- **IR LED Mode** : On: 12EA, Off: 6EA
- **IR Mode** : When IR LED is turned on in B/W, the objects can be clearly identified due to the function that decreases screen saturation of objects within a short distance.

IR MODE SETUP		
TOP	*	50
BOTTOM	*	110
LEFT	*	52
RIGHT	*	118

- **AUTO** : The mode is switched to 'Color' in a normal environment, but switches to 'B/W' mode when ambient illumination is low.  
To set up the switching time for AUTO mode, press the Function Setup switch.

AUTO SETUP		
▶ 1. BURST MODE		ON
2. COLOR→B/W		
DURATION		FAST
DWELL TIME		3 SEC
3. B/W→COLOR		
DURATION		FAST
DWELL TIME		10 SEC
4. RETURN ◀		

- **BURST MODE** : You can turn on or off the burst signal on B/W mode.
- **DWELL TIME** : You can select the duration time about changing the day/night mode.  
→3s, 5s, 7s, 10s, 15s, 20s, 30s, 40s, 60s
- **DURATION** : You can select the brightness level at which the camera switches from day to night mode.

	Color → B/W	B/W → Color
Fast	2.5 lux	5 lux
Slow	1 lux	10 lux

※ Light levels are often site dependant.



- When AGC in the EXPOSURE menu is 'OFF', '---' mode operates as selecting 'COLOR' mode and 'AUTO' mode cannot be selected.
- The OSD key does not work for 3 seconds when switching to Color or B/W, to ensure stable camera operation.
- BLC function does not work in B/W mode.

# setup

## SPECIAL

1. When the SETUP menu screen is displayed, select 'SPECIAL' by using the Function Setup switch so that the arrow indicates 'SPECIAL'.

MAIN SETUP		
1.LENS		DC←┘
2.EXPOSURE←┘		
3.WHITE BAL		ATW
4.SSDR		OFF
5.BACKLIGHT		OFF
6.SSNR3		ON←┘
7.DAY/NIGHT		AUTO←┘
▶ 8.SPECIAL←┘		
9.EXIT		SAVE

2. Select a desired mode using the Function Setup switch.

SPECIAL		
▶ 1.IMAGE ADJ←┘		
2.MONITOR		LCD←┘
3.CAM TITLE		OFF
4.MOTION DET		OFF
5.PRIVACY		OFF
6.DIS		OFF
7.LANGUAGE		ENGLISH
8.RETURN←┘		

### • IMAGE ADJ :

- 1) When the SPECIAL menu screen is displayed, select 'IMAGE ADJ' by using the Function Setup switch so that the arrow indicates 'IMAGE ADJ'.

- 2) Select a desired mode using the Function Setup switch.

- V-REV : You can flip the picture vertically on the screen.
- H-REV : You can flip the picture horizontally on the screen.
- D-ZOOM : You can use a digital zoom of x1 ~ x16.
- FONT COLOR : You can change the OSD font color.  
(White, Yellow, Green, Red, Blue)
- SHARPNESS : As you increase this value, the picture outline becomes stronger and clearer. Adjust this value appropriately depending on the sharpness of the picture.
- RETURN : Select this to save the settings for the IMAGE ADJ menu and to return to the SPECIAL menu.

IMAGE SETUP		
▶ 1.V-REV		OFF
2.H-REV		OFF
3.D-ZOOM		OFF
4.FONT COLOR		WHITE
5.SHARPNESS		ON←┘
6.RETURN←┘		

- ⚠ If you increase the SHARPNESS level too high, the picture may become distorted or noise may appear.

- **Monitor** : Please change the settings value of video appropriate to your monitor.

- LCD : Please select this menu item when using an LCD monitor.  
You can change the gamma, PED level and color gain in the sub menus.

- CRT : Please select this menu item when using a CRT monitor.

- USER : Please use this menu item when using a monitor other than standard ones.  
You can change the gamma, PED level and color gain in the sub menus.

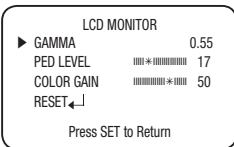

- **CAM TITLE** :

If you enter a title, the title will appear on the monitor.

- 1 If the SPECIAL menu screen is displayed, use the Function Setup switch so that the arrow indicates 'CAM TITLE'.
- 2 Set it to 'ON' by using the Function Setup switch.
- 3 Press the Function Setup switch.
- 4 Use the Function Setup switch to move to a desired letter and select the letter by pressing the switch. Repeat this to enter multiple letters. You can enter up to 15 letters.
- 5 Enter a title, move the cursor to 'POS' and press the Function Setup switch. The entered title appears on the screen. Select the position to display the title on the screen by using the Function Setup switch and press. When the position is determined, select 'END' and press the Function Setup switch to return to the SPECIAL menu.

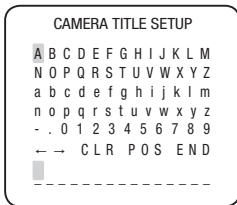

## setup



- When the CAM TITLE menu is 'OFF', no title will be displayed on the monitor screen even if you enter one.
- Only English is available in the mode.
- If you move the cursor to CLR and press the Function Setup switch, all the letters are deleted. To edit a letter, change the cursor to the bottom left arrow and press the Function Setup switch. Move the cursor over the letter to be edited, move the cursor to the letter to be inserted and then press the Function Setup switch.

### • MOTION DET :

This product has a feature that allows you to observe movement of objects in 8 different areas on the screen, and the words 'MOTION DETECTED' appear on the screen when movement is detected. You can monitor activity more efficient.

- 1 When the SPECIAL menu screen is displayed, press the Function Setup switch so that the arrow indicates 'MOTION DET'.

- 2 Set up the mode using the Function Setup switch.

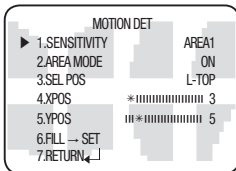

#### - SENSITIVITY :

You can select up to 8 MD areas.

When SENSITIVITY number is high, motion detection sensitivity is increased to recognize even small movement.

- AREA MODE : Determines whether to use the MD area selected in SENSITIVITY.
- SEL POS : Determines which of the 4 vertices of each MD area is to be used.
- XPOS : Determines the coordinate of the horizontal axis for SEL POS.
- YPOS : Determines the coordinate of the vertical axis for SEL POS.
- FILL → SET : Fills in a selected MD area. The color of filling is sequentially selected as brown, orange, blue, cyan, yellowish green, yellow, magenta and red.
- RETURN : Select this to save the MOTION DET menu settings and return to the SPECIAL menu.



- MD areas show only MOTION DET menu. Therefore, MD areas are only displayed while setting the MD menu.

- **PRIVACY** : Mask an area you want to hide on the screen.

① When the SPECIAL menu screen is displayed, press the Function Setup switch so that the arrow indicates 'PRIVACY'.

② Set up the mode using the Function Setup switch.

- **AREA** : You can select up to 12 PRIVACY areas.
- **MODE** : Determines whether to use the area selected in the AREA SEL, and the size and position of the area.

- **MASK COLOR** : Determine area color. You can select GREEN, RED, BLUE, BLACK, WHITE and GRAY.

- **MASK TONE** : Adjust the brightness of MASK COLOR.

- **TOP/BOTTOM/LEFT/RIGHT** : Adjust the size and position of the selected area.

- **RETURN** : Select this to save the PRIVACY menu settings and return to the SPECIAL menu.

PRIVACY AREA SETUP		
▶ 1.AREA		AREA1
2.MODE		OFF
3.MASK COLOR		GREEN
4.MASK TONE	*■■■■■■■■	1
5.TOP	■■■■■■■■	39
6.BOTTOM	■■■■■■■■	79
7.LEFT	*■■■■■■■■	13
8.RIGHT	■■■■■■■■	52
9.RETURN	◀	

- **DIS (Digital Image Stabilizer)** :

This function mitigates any picture movement due to external factors such as wind.



- As the DIS function uses the digital zoom the camera's resolution will decrease.
- DIS doesn't operate when background illumination is too low.
- DIS doesn't operate when object pattern is monotonic as like sky or white wall.
- If DIS is enabled, the digital zoom is not configured to less than x1.2 level.

- **LANGUAGE** : You can select the menu language according to your requirements.

- **RETURN** : Select this to save the SPECIAL menu settings and return to the MAIN SETUP menu.

# setup

---

## **EXIT**

---

Select a desired EXIT mode using the Function Setup switch depending on the camera purpose.

- **SAVE** : Save the current settings and exit the MAIN SETUP menu.
- **NOT SAVE** : Do not save the current settings and exit the MAIN SETUP menu.
- **RESET**: Resets the camera settings to the factory defaults.  
Language and Monitor settings are not initialized.

# troubleshooting

## TROUBLESHOOTING

If you have trouble operating your camera, refer to the following table. If the guidelines do not enable you to solve the problem, contact an authorized technician.

PROBLEM	SOLUTION
Nothing appears on the screen.	<ul style="list-style-type: none"><li>▶ Check that the power cord and line connection between the camera and monitor are fixed properly.</li><li>▶ Check that you have properly connected VIDEO cable to the camera VIDEO output jack.</li></ul>
The image on the screen is dim.	<ul style="list-style-type: none"><li>▶ Is the lens stained with dirt? Clean your lens with a soft, clean cloth.</li><li>▶ Check the monitor and DVR settings.</li><li>▶ If the camera is exposed to very strong light, change the camera position.</li></ul>
The image on the screen is dark.	<ul style="list-style-type: none"><li>▶ Adjust the contrast feature of the monitor or DVR.</li><li>▶ If you have an intermediate device, set the 75Ω / Hi-z properly.</li></ul>
The camera is not working properly, and the surface of the camera is hot.	<ul style="list-style-type: none"><li>▶ Check that you have properly connected the camera to an appropriate power source.</li></ul>
The DAY/NIGHT menu does not work.	<ul style="list-style-type: none"><li>▶ Check that AGC of EXPOSURE SETUP menu is 'OFF'.</li></ul>
The SENS-UP function does not work.	<ul style="list-style-type: none"><li>▶ Check that AGC of EXPOSURE SETUP menu is 'OFF'.</li><li>▶ Check that SHUTTER of EXPOSURE SETUP menu is 'A.FLK' or 'MANUAL'.</li></ul>
The Motion Detection function does not work.	<ul style="list-style-type: none"><li>▶ Check that MOTION DEF of SPECIAL SETUP menu is 'OFF'.</li></ul>
Color is not correct.	<ul style="list-style-type: none"><li>▶ Check the setting of WHITE BAL SETUP menu .</li></ul>
The screen flickers continually.	<ul style="list-style-type: none"><li>▶ Check that the camera is not pointing at the sun.</li></ul>
IR-LED isn't lighted.	<ul style="list-style-type: none"><li>▶ Isn't DAYNIGHT function setting up the color mode? Please change the AUTO or BAW mode.</li></ul>

# specifications

## SPECIFICATIONS

	SCD-2080RN	SCD-2080RP
<b>Video</b>		
<b>Imaging Device</b>	1/3" Super HAD CCD II	
<b>Total Pixels</b>	811(H) x 508(V)	795(H) x 596(V)
<b>Effective Pixels</b>	768(H) x 494(V)	752(H) x 582(V)
<b>Scanning System</b>	2:1 Interlace	
<b>Synchronization</b>	Internal	
<b>Frequency</b>	H : 15.734KHz V:59.94Hz	H: 15.625KHz V: 50.Hz
<b>Horizontal Resolution</b>	Color : 600 TV lines, B/W : 700TV lines	
<b>Min. Illumination</b>	Color : 0.15Lux (50IRE@F1.2), 0.0003Lux(Sens-up, x512) B/W : 0Lux (LED on)	
<b>S/N (Y Signal)</b>	52dB (Weight On, AGC Off)	
<b>Video Output</b>	CVBS : 1.0Vp-p, 75Ω composite	
<b>Lens Type</b>		
<b>Focal Length (Zoom Ratio)</b>	2.8 ~ 10mm (3.6x)	
<b>Max. Aperture Ratio</b>	1:1.2(Wide) ~ 2.8(Tele)	
<b>Angular Field of View</b>	H: 94.4°(Wide) ~ 28°(Tele) / V: 69.2°(Wide) ~ 21°(Tele)	
<b>Min. Object Distance</b>	0.2m	
<b>Lens Type</b>	DC Auto Iris	
<b>Mount Type</b>	Board Type	
<b>Pan / Tilt</b>		
<b>Pan Range</b>	0° ~ 352°	
<b>Tilt Range</b>	0° ~ 73°	
<b>Rotate Range</b>	0° ~ 348°	
<b>Operational</b>		
<b>On Screen Display</b>	Multi-language Support by Coaxial Cable English, French, Spanish, Japanese, Korean, Portuguese, Taiwanese	Multi-language Support by Coaxial Cable English, French, German, Spanish, Italian, Chinese, Czech, Danish, Polish, Portuguese, Russian, Romanian, Serbian, Swedish, Turkish



	SCD-2080RN	SCD-2080RP
<b>SSDR</b>	On / Off (Level adjustable)	
<b>Backlight Compensation</b>	BLC / HLC / OFF	
<b>Camera Title</b>	Off / On (Displayed 15 characters)	
<b>Day &amp; Night</b>	Auto (ICR) / Color / B/W	
<b>Backlight Compensation</b>	BLC / HLC / Off	
<b>Contrast Enhancement</b>	SSDR (Off / On)	
<b>Digital Noise Reduction</b>	SSNR3 ( Off/On )	
<b>Digital Image Stabilization</b>	Off / On	
<b>Motion Detection</b>	Off / On (8 programmable zones)	
<b>Privacy Masking</b>	Off / On (12 programmable zones)	
<b>Sens-up (Frame Integration)</b>	2x ~ 512x	
<b>Gain Control</b>	Off / Low / High	
<b>White Balance</b>	ATW / Outdoor / Indoor / Manual / AWC (1,700K° ~ 11,000K°)	
<b>Electronic Shutter Speed</b>	1/60 ~ 1/120,000 sec	1/50 ~ 1/120,000 sec
<b>Digital Zoom</b>	Off / On (1x ~ 16x)	
<b>Reverse</b>	H-Rev ( Off/On ), V-Rev ( Off/On )	
<b>Communication</b>	Coaxial Control ( SPC-300 Compatible )	
<b>Protocol</b>	Pelco-C (Coaxitron)	
<b>IR Distance</b>	20m ( IR LED 12 EA )	
<b>Environmental</b>		
<b>Operating Temperature / Humidity</b>	-10°C ~ +50°C (+14°F ~ +122°F) / Less than 90% RH	
<b>Electrical</b>		
<b>Input Voltage</b>	12V DC ±10%	
<b>Power Consumption</b>	Max. 3.5W	
<b>Mechanical</b>		
<b>Color / Material</b>	Ivory / Plastic ( Dome Cover : Smoked )	
<b>Dimension (ø×H)</b>	ø115.8x92.7mm	
<b>Weight</b>	310g	

※ This specification can be changed without notice for performance improvement of product.

# specifications

---

## DIMENSION

---

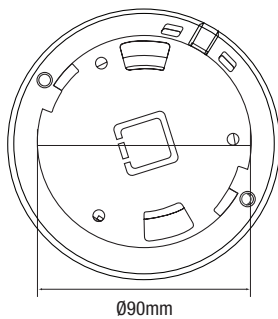
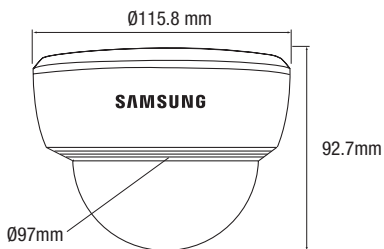

**MEMO**

MEMO

MEMO

**MEMO**

MEMO



## SALES NETWORK

---

### SAMSUNG TECHWIN CO., LTD.

Samsungtechwin R&D Center, 701, Sampyeong-dong, Bundang-gu, Seongnam-si, Gyeonggi-do, Korea, 463-400  
TEL : +82-70-7147-8740~60, FAX : +82-31-8018-3745

### SAMSUNG TECHWIN AMERICA Inc.

1480 Charles Willard St, Carson, CA 90746, UNITED STATES  
Tol Free : +1-877-213-1222, FAX : +1-310-632-2195  
[www.samsungcctvusa.com](http://www.samsungcctvusa.com)

### SAMSUNG TECHWIN EUROPE LTD.

Samsung House, 1000 Hillswood Drive, Hillswood Business Park  
Chertsey, Surrey, UNITED KINGDOM KT16 0PS  
TEL : +44-1932-45-5300, FAX : +44-1932-45-5325

---

[www.samsungtechwin.com](http://www.samsungtechwin.com)

[www.samsungsecurity.com](http://www.samsungsecurity.com)

P/NO. : Z6806156202A