

EU Declaration of Conformity

SAMSUNG



We hereby declare that the product

Type of equipment : NETWORK CAMERA
Brand Name / Trade Mark : SAMSUNG
Model number : QNV-7030RP
Variant Model : QNV-7020RP, QNV-7010RP

satisfies all the technical regulations applicable to the product within the scope of Council Directives 2014/30/EU

EN 55022:2010 : Limits and methods of measurement of radio disturbance characteristics of information technology equipment
EN 50581:2012 : Technical documentation for the assessment of electrical and electronic products with respect to the restriction of hazardous substances
EN 50130-4:2011+A1:2014 : Product family standard: Immunity requirements for components of fire, intruder and social alarm systems
EN 61000-4-2:2009 : Electrostatic discharge immunity test
EN 61000-4-3:2006+A2:2010 : Radiated, radio-frequency, electromagnetic field immunity test
EN 61000-4-4:2012 : Electrical fast transient/burst immunity test
EN 61000-4-5:2014 : Surge immunity test
EN 61000-4-6:2009 : Immunity to conducted disturbances, induced by radio-frequency fields

All essential testing suites have been carried out.

Manufacturer : Tianjin Samsung Techwin Opto-Electronic Co., Ltd.
Manufacturer address : No.11 Weiliu Rd, Micro-Electronic Industrial Park, TEDA, Tianjin, 300385, People's Republic of China
Telephone / Fax : 82-02-729-2900 / 82-02-729-2904 (www.hanwhatechwin.com)
Applicant : Hanwha Techwin Co., Ltd.
Applicant address : 1204, Changwon-daero, Seongsan-gu, Chang-won-si, Gyeongsangnam-do, Korea

This declaration is issued under the sole responsibility of the manufacturer and his authorised representative.

Authorized signatory

Name / Title : Jei Soon, Kang / Principal Research Engineer
Date of issue : May. 16, 2016



EMC TEST REPORT For CE

Test Report No. : KES-E1-16T0211
Date of Issue : May. 16, 2016
Product name : NETWORK CAMERA
7
Model/Type No. : QNV-7030RP
Variant Model : QNV-7020RP, QNV-7010RP
Applicant : Hanwha Techwin Co., Ltd.
Applicant Address : 1204, Changwon-daero, Seongsan-gu, Changwon-si,
Gyeongsangnam-do, korea
Manufacturer : Tianjin Samsung Techwin Opto-Electronic Co., Ltd.
Manufacturer Address : No.11 Weiliu Rd, Micro-Electronic Industrial Park, TEDA, Tianjin,
300385, People's Republic of China
Date of Receipt : May. 02, 2016
Test date : May. 09, 2016 – May. 11, 2016
Test Results : **In Compliance** **Not in Compliance**

Tested by

Yeong Suk, Song
EMC Test Engineer

Reviewed by

Dong-Hun, Jang
EMC Technical Manager



KES Co., Ltd.

C-3701, Simin-daero 365-40,
Dongan-gu, Anyang-si, Gyeonggi-do, 14057, Korea
Tel: +82-31-425-6200 / Fax: +82-31-424-0450
www.kes.co.kr

Test report No.:
KES-E1-16T0211
Page (2) of (76)

REPORT REVISION HISTORY

Date	Test Report No.	Revision History
May. 16, 2016	KES-E1-16T0211	Issued

This report shall not be reproduced except in full, without the written approval of KES Co., Ltd. This document may be altered or revised by KES Co., Ltd. personnel only, and shall be noted in the revision section of the document. Any alteration of this document not carried out by KES Co., Ltd. will constitute fraud and shall nullify the document.

This report shall not be reproduced except in full, without the written approval of KES Co., Ltd.
The results shown in this test report refer only to the sample(s) tested unless otherwise stated.



TABLE OF CONTENTS

1.0	General Product Description	4
1.1	Test Voltage & Frequency	5
1.2	Variant Model Differences.....	5
1.3	Device Modifications	5
1.4	Equipment Under Test	5
1.5	Support Equipments.....	5
1.6	External I/O Cabling.....	6
1.7	E.U.T Operating Mode(s).....	6
1.8	Configuration	7
1.9	Calibration Details of Equipment Used for Measurement	8
1.10	Test Facility.....	8
1.11	Laboratory Accreditations and Listings	8
2.0	Test Regulations	9
2.1	Conducted Emissions at Mains Power Ports	11
2.2	Conducted Emissions at Telecommunication Ports.....	12
2.3	Radiated Electric Field Emissions(Below 1 GHz).....	13
2.4	Radiated Electric Field Emissions(Above 1 GHz)	14
2.5	Harmonic Current Emissions	15
2.6	Voltage Fluctuations and Flicker	16
3.0	Criteria for compliance.....	17
3.1	Electrostatic Discharge	19
3.2	Radiated Electric Field Immunity	22
3.3	Electrical Fast Transients/Bursts	25
3.4	Surge Transients.....	28
3.5	Conducted Disturbance.....	31
3.6	Voltage Dips and Short Interruptions	34
APPENDIX A	– TEST DATA	36
	Conducted Emissions at Mains Power Ports.....	36
	Conducted Emissions at Telecommunication Ports.....	38
	Radiated Electric Field Emissions(Below 1 GHz)	42
	Radiated Electric Field Emissions(Above 1 GHz)	43
	Harmonic Current Emissions and Voltage Fluctuations and Flicker	51
	Test Setup Photos and Configuration.....	54
	Conducted Voltage Emissions	54
	Conducted Telecommunication Emissions	55
	Radiated Electric Field Emissions(Below 1 GHz)	57
	Radiated Electric Field Emissions(Above 1 GHz)	59
	Harmonic Current Emissions and Voltage Fluctuations and Flicker	61
	Electrostatic Discharge	62
	Radiated Electric Field Immunity	63
	Electrical Fast Transients/Bursts.....	64
	Surge Transients.....	66
	Conducted Disturbance.....	67
	Voltage Dips and Short Interruptions	69
	EUT External Photographs.....	70
	EUT Internal Photographs	71

This report shall not be reproduced except in full, without the written approval of KES Co., Ltd.
The results shown in this test report refer only to the sample(s) tested unless otherwise stated.



1.0 General Product Description

Main Specifications of E.U.T are:

QNV-7030R			
Video		Ethernet	RJ-45 (10/100BASE-T)
Imaging Device	1/3" 4M CMOS	Video Compression Format	H.265, H.264, MJPEG
Total Pixels	2720x1536	Resolution	2592x1520, 2560x1440(16:9) / 2304x1296 / 1920x1080 / 1280x1024 / 1280x960 / 1280x720 / 1024x768 / 800x600 / 800x450 / 720x576 / 720x480 / 640x480 / 640x360 / 320x240
Effective Pixels	2688x1520	Max. Framerate	H.265 : Max 20fps at 4M, Max 30fps at 2M all resolutions H.264 : Max 20fps at 4M, Max 30fps at 2M all resolutions MJPEG : Max 15fps @ all resolution.
Scanning System	Progressive	Smart codec	Wise Stream
Min. Illumination	Color : 0.3Lux, B/W : 0Lux	Video Quality Ajustment	H.265 : Target Bitrate Level Control H.264 : Target Bitrate Level Control MJPEG : Quality Level Control
Lens		Bitrate control method	H.265 : CBR or VBR H.264 : CBR or VBR MJPEG : VBR
Focal Length (Zoom Ratio)	Fixed 6mm (F2.2)	Streaming Capability	Multiple Streaming(Up to 3 Profiles)
Max. Aperture Ratio	F2.2	Audio I/O	Line in
Angular Field of View	D 62° / H 53° / V 31°	Audio Compression Format	G.711 u-law /G.726 Selectable G.726(ADPCM) : 8KHz, G.711 : 8KHz G.726 : 16Kbps, 24Kbps, 32Kbps, 40Kbps
Min. Object Distance	-	Audio Communication	Uni-directional
Lens Type	Fixed	IP	IPv4, IPv6
Mount Type	Board type	Protocol	TCP/IP, UDP/IP, RTP(UDP), RTP(TCP), RTCP,RTSP, NTP, HTTP, HTTPS, SSL/TLS, DHCP, PPPoE, FTP, SMTP, ICMP, IGMP, SNMPv1/v2c/v3(MIB-2), ARP, DNS, DDNS, QoS, PIM-SM, UPnP, Bonjour
Pan / Tilt / Rotate		Security	HTTPS(SSL) Login Authentication Digest Login Authentication IP Address Filtering User access Log 802.1X Authentication
Pan Range	0~350°	Streaming Method	Unicast / Multicast
Tilt Range	0~67°	Max. User Access	6 users at Unicast Mode
Rotate Range	0~355°	Edge storage	Micro SD/SDHC/SDXC Max 128G, NAS - Motion images recorded in the SD memory card can be downloaded - Manual recording at Local PC
Operational		Application Programming Interface	ONVIF Profile S, G SUNAPI(HTTP API)
IR Viewable Length	30m	Webpage Language	English, French, German, Spanish, Italian, Chinese, Korean, Russian, Japanese, Swedish, Danish, Portuguese, Turkish, Polish, Czech, Rumanian, Serbian, Dutch, Croatia, Hungary, Greek, Finnish, Norwegian
Camera Title	Off / On (Displayed up to 20 characters per line) - W/W : English/Numeric/Special Characters - China : English/Numeric/Special/Chinese Characters - Common : Multi-line (Max 5), Color (Grey/Green/Red/Blue/Black/White), Transparency, Auto Scale by Resolution	Web Viewer	Supported OS: Windows 7, 8, 10, Mac OS X 10.8, 10.9, 10.10, 10.11 [Non-plugin Webviewer] Supported Browser: Google Chrome 47, MS Edge 20 Support Codec : Video-H.264, MJPEG (Max. 1M 15fps), Audio-G.711 [Plug-in Webviewer] Supported Browser : MS Explore 11 , Mozilla Firefox 43, Apple Safari 9 * Mac OS X only
Day & Night	True Day & Night	Central Management Software	SmartViewer
Backlight Compensation	Off / BLC	Pixel Counter	Support (plug-in viewer only)
Highlight Compensation	(미지원)	Environmental	
Wide Dynamic Range	120dB	Operating Temperature / Humidity	-30°C ~ +55°C / Less than 90% RH * Start up should be done at above -20°C
Digital Noise Reduction	SSNR(Off / On)	Storage Temperature / Humidity	-30°C ~ +60°C (-22°F ~ +140°F) / Less than 90% RH
Motion Detection	Off / On (4ea polygon zones)	Ingress Protection	IP66
Privacy Masking	Off / On (6ea rectangler zones)	Vandal Resistance	IK10
Gain Control	Off / Low / Middle / High	Electrical	
White Balance	ATW / AWC / Manual / Indoor / Outdoor	Input Voltage / Current	PoE(IEEE802.3af, Class3) DC 12V
LDC(Lens distortion control)	On/Off (5 levels with Min/Max)	Power Consumption	Max.6.8W(PoE), Max.5.7W(DC12V)
Electronic Shutter Speed	Minimum / Maximum / Anti flicker	Mechanical	
Flip / Mirror	Flip / Mirror / Hallway view	Color / Material	Ivory / Metal
Intelligent Video Analytics	Motion Detection with metadata, Tampering, Defocus	Dimension (WxHxD)	φ120 x H92
Alarm I/O	Input 1 / Output 1	Weight	490g
Alarm Triggers	Motion detection, Tampering Detection, SD card error, NAS error, Alarm input, Defocus detection		
Alarm Events	File upload via FTP and E-Mail Local storage recording at Event Notification via E-Mail External output		
Network			

This report shall not be reproduced except in full, without the written approval of KES Co., Ltd.
The results shown in this test report refer only to the sample(s) tested unless otherwise stated.

1.1 Test Voltage & Frequency

Unless indicated otherwise on the individual data sheet or test results, the test voltage and frequency was as indicated below.

Voltage 220 Vac 230 Vac 240 Vac PoE 12 Vdc
 Frequency 50 Hz 60 Hz Hz

1.2 Variant Model Differences

Variant Model	Remarks
QNV-7020RP	Focus Length differences
QNV-7010RP	

1.3 Device Modifications

Not applicable

1.4 Equipment Under Test

Description	Model Number	Serial Number	Manufacturer	Remarks
NETWORK CAMERA	QNV-7030RP	-	Tianjin Samsung Techwin Opto-Electronic Co., Ltd.	E.U.T

1.5 Support Equipments

Description	Model Number	Serial Number	Manufacturer	Remarks
PoE	HICC-P-2100XIRV	15030100002	Honeywell	-
Notebook	NT630Z5J	JK9091EF400142M	Samsung Electronics Suzhou Computer Co., Ltd.	-
NotebookK Adapter	A13-040N2A	CN60BA4400313ADON 843K0200	Chicony Power Technology (suzhou)Co., Ltd.	-
Alarm	SIE-0001 DO	C54167JB601268 F	SAMSUNG TECHWIN CO., LTD.	-
Micro SD card	-	-	Transcend	4 GB

This report shall not be reproduced except in full, without the written approval of KES Co., Ltd.
The results shown in this test report refer only to the sample(s) tested unless otherwise stated.

1.6 External I/O Cabling

- DC 12 V Mode

Start		END		Cable Spec.	
Description	I/O Port	Description	I/O Port	Length	Shield
NETWORK CAMERA (E.U.T)	Alarm IN	Alarm	Alarm IN	3.0	U
	RJ-45	Notebook	RJ-45	4.0	U
	Micro SD card SLOT	Micro SD card	Micro SD card SLOT	-	-

- PoE Mode

Start		END		Cable Spec.	
Description	I/O Port	Description	I/O Port	Length	Shield
NETWORK CAMERA (E.U.T)	RJ-45(PoE)	PoE Adapter	RJ-45(PoE)	3.0	U
PoE Adapter	RJ-45(LAN)	Notebook	RJ-45(LAN)	0.3	U
NETWORK CAMERA	Audio In	MicroPhone	Audio Out	1.3	U
(E.U.T)	Audio Out	Speaker	Audio In	1.4	U

* Unshielded=U, Shielded=S

1.7 E.U.T Operating Mode(s)

Equipment under test was operated during the measurement under the following conditions:

Test mode	Normal operating
OP	MONITORING Network ping test

- Input power condition during the measurements was 12 V (dc) , PoE

1.8 Configuration

■ AC Main
 □ DC Main

- DC 12 V Mode

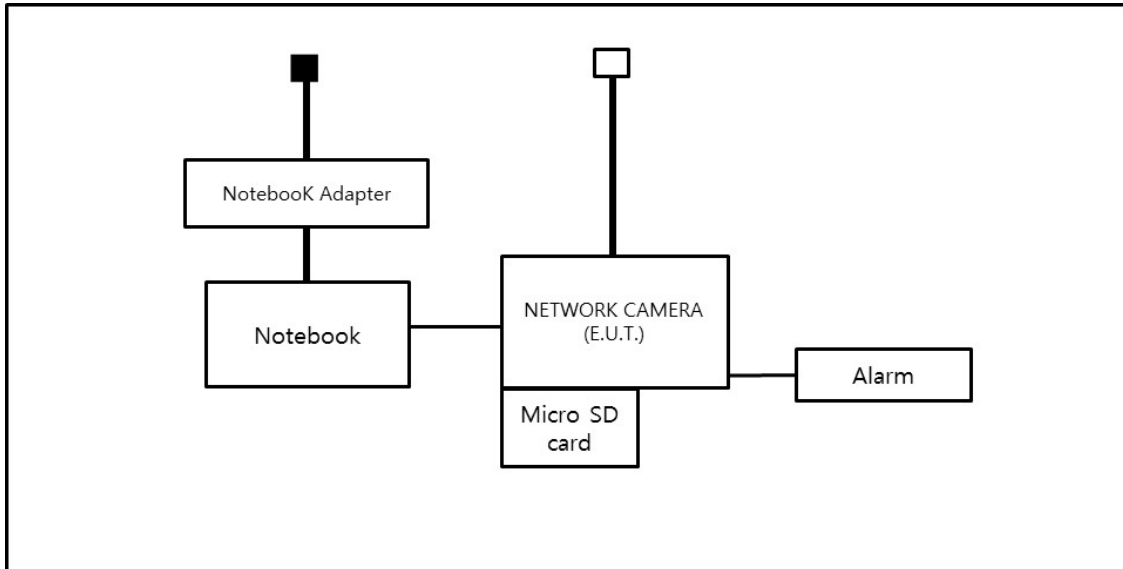

- PoE Mode

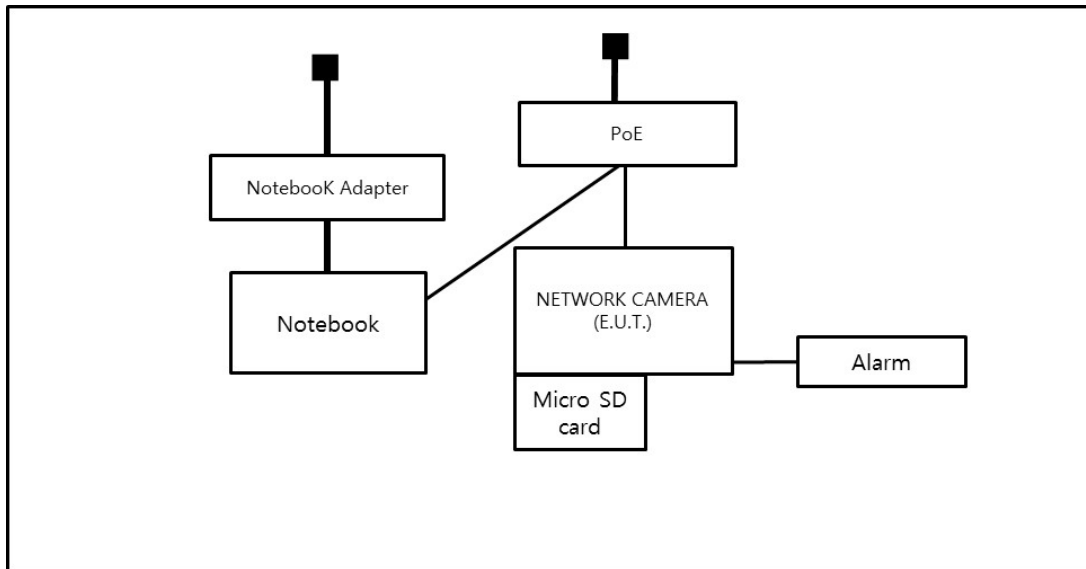

This report shall not be reproduced except in full, without the written approval of KES Co., Ltd.
 The results shown in this test report refer only to the sample(s) tested unless otherwise stated.







1.9 Calibration Details of Equipment Used for Measurement

Test equipment and test accessories are calibrated on regular basis. The maximum time between calibrations is one year or what is recommended by the manufacturer, whichever is less.

1.10 Test Facility

The measurement facility is located at 473-29 Gayeo-ro, Yeosu-si, Gyeonggi-do, 12658, Korea. The sites are constructed in conformance with the requirements of ANSI C63.4 and CISPR Publication 22.

1.11 Laboratory Accreditations and Listings

Country	Agency	Scope of Accreditation	Logo
USA	FCC	3 & 10 meter Open Area Test Sites and one conducted site to perform FCC Part 15/18 measurements.	
JAPAN	VCCI	Mains Ports Conducted Interference Measurement, Telecommunication Ports Conducted Disturbance Measurement and Radiation 10 meter site, Facility for measuring radiated disturbance above 1 GHz	 R-4308, C-4798, T-2311, G-914
KOREA	MSIP	EMI (10 meter Open Area Test Site and two conducted sites) Radio(3 & 10 meter Open Area Test Sites and one conducted site) EMS (ESD, RS, EFT/Burst, Surge, CS, Magnetic, Dips and interruptions)	 KR0100
Canada	IC	3 & 10 meter Open Area Test Sites and one conducted site	 4769B-1
Europe	CE	EMI (10 meter Open Area Test Site and two conducted sites) Radio(3 & 10 meter Open Area Test Sites and one conducted site) EMS (ESD, RS, EFT/Burst, Surge, CS, Magnetic, Dips and interruptions)	
International	KOLAS	EMI (10 meter Open Area Test Site and two conducted sites) Radio(3 & 10 meter Open Area Test Sites and one conducted site) EMS (ESD, RS, EFT/Burst, Surge, CS, Magnetic, Dips and interruptions)	

2.0 Test Regulations

The emissions tests were performed according to following regulations:

EMC – Directive 2014/30/EU

EN 61000-6-3:2011

EN 61000-6-1:2007

EN 61000-6-4:2007 +A1:2011

EN 61000-6-2:2005

EN 55011:2007 +A1:2010

Group 1
 Class A

Group 2
 Class B

EN 55014-1:2006 +A2:2011

EN 55014-2:1997 +A2:2008

EN 55015:2013

EN 55022:2010

Class A

Class B

EN 55024:2010

EN 50130-4:2011 +A1:2014

EN 61000-3-2:2014

EN 61000-3-3:2013

EN 61326-1:2013

VCCI V-3 / 2013.04

Class A

Class B

AS / NZS CISPR22:2009 +A1:2010

Class A

Class B

47 CFR Part 15, Subpart B / ANSI C63.4-2009

Class A

Class B

IC Regulation ICES-003 : 2012
/ ANSI C63.4-2014

Class A

Class B

CISPR 22:2009 +A1:2010

Class A

Class B



KES Co., Ltd.

C-3701, Simin-daero 365-40,
Dongan-gu, Anyang-si, Gyeonggi-do, 14057, Korea
Tel: +82-31-425-6200 / Fax: +82-31-424-0450
www.kes.co.kr

Test report No.:
KES-E1-16T0211
Page (10) of (76)

R&TTE – Directive 1999/5/EC

EN 301 489-1 V1.9.2

- Equipment for fixed use
- Equipment for vehicular use
- Equipment for portable use

EN 301 489-3 V1.6.1

EN 301 489-17 V2.2.1

EN 60945:2002

This report shall not be reproduced except in full, without the written approval of KES Co., Ltd.
The results shown in this test report refer only to the sample(s) tested unless otherwise stated.

2.1 Conducted Emissions at Mains Power Ports

Test Date

N/A

Test Location

Electro wave Shieldroom

Test Equipment

Used	Description	Model Number	Manufacturer	Serial Number	Cal. Due
<input type="checkbox"/>	EMI Test Receiver	ESR3	R&S	101783	05, 03, 2017
<input type="checkbox"/>	LISN	ENV216	R&S	101137	02, 04, 2017
<input type="checkbox"/>	LISN	ENV216	R&S	101786	05, 02, 2017
<input type="checkbox"/>	Electro wave Shieldroom	-	SEMITEC	-	-

Test Conditions

Temperature: °C

Relative Humidity: %

Frequency Range of Measurement

150 kHz to 30 MHz

Instrument Settings

IF Band Width: 9 kHz

Test Results

The requirements are:

- PASS
 NOT PASS
 NOT APPLICABLE

Remarks

Because the E.U.T power is 12 V (dc) power and PoE, limits are not specified

2.2 Conducted Emissions at Telecommunication Ports

Test Date

May. 09, 2016

Test Location

Electro wave Shieldroom

Test Equipment

Used	Description	Model Number	Manufacturer	Serial Number	Cal. Due
<input checked="" type="checkbox"/>	EMI Test Receiver	ESR3	R&S	101783	05, 03, 2017
<input checked="" type="checkbox"/>	LISN	ENV216	R&S	101137	02, 04, 2017
<input checked="" type="checkbox"/>	LISN	ENV216	R&S	101786	05, 02, 2017
<input checked="" type="checkbox"/>	8-Wire ISN CAT3	CAT3 8158	Schwarzbeck Mess	8158-0019	04, 01, 2017
<input checked="" type="checkbox"/>	8-Wire ISN CAT5	CAT5 8158	Schwarzbeck Mess	8158-0030	04, 01, 2017
<input type="checkbox"/>	8-Wire ISN CAT6	NTFM 8158	Schwarzbeck Mess	8158-0029	08, 14, 2016
<input checked="" type="checkbox"/>	Electro wave Shieldroom	-	SEMITEC	-	-

Test Conditions

Temperature: 25,7 °C

Relative Humidity: 39,7 %

Frequency Range of Measurement

150 kHz to 30 MHz

Instrument Settings

IF Band Width: 9 kHz

Test Results

The requirements are:

- PASS
 NOT PASS
 NOT APPLICABLE

Remarks

See Appendix A for test data.

2.4 Radiated Electric Field Emissions(Above 1 GHz)

Test Date

May. 09, 2016

Test Location

Semi Anchoic Chamber #2

Test Equipment

Used	Description	Model Number	Manufacturer	Serial Number	Cal. Due
<input checked="" type="checkbox"/>	DOUBLE RIDGED HORN ANTENNA	SAS-571	A.H.SYSTEM,INC	781	05, 07, 2017
<input checked="" type="checkbox"/>	EMI Test Receiver	ESU26	R&S	100551	04, 18, 2017
<input checked="" type="checkbox"/>	Broadband Coaxial Preampfier	BBV 9718	Schwarzbeck Mess - Elektronik	9718-246	10, 23, 2016
<input checked="" type="checkbox"/>	Semi Anchoic Chamber #2	-	SEMITEC	-	-
<input checked="" type="checkbox"/>	Antenna Mast	-	AUDIX	-	-
<input checked="" type="checkbox"/>	Turn Table	-	AUDIX	-	-

Test Conditions

Temperature: 25,7 °C
Relative Humidity: 39,7 %

Frequency Range of Measurement

1 GHz to 6 GHz

Instrument Settings

IF Band Width: 1 MHz

Test Results

The requirements are:

- PASS
 NOT PASS
 NOT APPLICABLE

Remarks

See Appendix A for test data.



2.5 Harmonic Current Emissions

Test Date

N/A

Test Location

Electro wave Shieldroom

Test Equipment

Used	Description	Model Number	Manufacturer	Serial Number	Cal. Due
<input type="checkbox"/>	AC Source	ACS 500 N	EM TEST	V1024106760	08, 13, 2016
<input type="checkbox"/>	Digital Power Analyzer	DPA 500 N	EM TEST	V1024106759	08, 13, 2016

Test Conditions

Temperature: °C
Relative Humidity: %

Classification of Equipment for Harmonic Current Emissions

- Class A
- Class B
- Class C(Below 25 W)
- Class C(Above 25 W)
- Class D

Test Results

The requirements are:

- PASS
- NOT PASS
- NOT APPLICABLE

Remarks

Because the E.U.T power is less than 75 W, limits are not specified.



2.6 Voltage Fluctuations and Flicker

Test Date

N/A

Test Location

Electro wave Shieldroom

Test Equipment

Used	Description	Model Number	Manufacturer	Serial Number	Cal. Due
<input type="checkbox"/>	AC Source	ACS 500 N	EM test	V1024106760	08, 13, 2016
<input type="checkbox"/>	Digital Power Analyzer	DPA 500 N	EM test	V1024106759	08, 13, 2016

Test Conditions

Temperature: °C
Relative Humidity: %

Test Results

The requirements are:

- PASS
- NOT PASS
- NOT APPLICABLE

Remarks

Because the E.U.T power is 12 V (dc) power and PoE.

3.0 Criteria for compliance

Criteria for compliance was based on the following guidelines:
EN 50130-4:2011 +A1:2014 Alarm systems-Part 4: Electromagnetic compatibility Product family standard: Immunity requirements for components of fire, intruder and social alarm systems

The variety and the diversity of the apparatus within the scope of this document makes it difficult to define precise criteria for the evaluation of the immunity test results.

If as a result of the application of the tests defined in this standard, the apparatus becomes dangerous or unsafe then the apparatus shall be deemed to have failed the test.

A functional description and a definition of performance by the manufacture and noted in the test report, based on the following criteria:

Electrostatic discharge

There shall be no damage, malfunction or change of status due to the conditioning.

Flickering of an indicator during the application of discharge is permissible, providing that is no residual change in the EUT or any change in outputs, which could be interpreted by associated equipment as a change.

Radiated electromagnetic fields

There shall be no damage, malfunction or change of status due to the conditioning.

Flickering of an indicator during the application of discharge is permissible, providing which could be interpreted by associated equipment as a change, and no such

Flickering of indicators occurs at a field strength of 3 V/m.

For components of CCTV systems, where the picture is allowed at 10 V/m, providing.

(a) there is no permanent damage or change to EUT

(e.g. no corruption of memory or changes to programmable setting etc.)

(b) at 3 V/m, any deterioration of the picture is so minor that the system could still be used; and

(c) there is no observable deterioration of the picture at 1 V/m.

Fast transient burst / slow high energy voltage surge

There shall be no damage, malfunction or change of status due to the conditioning.

Flickering of an indicator during the application of discharge is permissible, providing

That there is no residual is permissible, providing that there is no residual change in the EUT or any change in outputs, which could be interpreted by associated equipment as a change.

Conducted RF immunity

There shall be no damage, malfunction or change of status due to the conditioning.

Flickering of an indicator during the application of discharge is permissible, providing

That there is no residual is permissible, providing that there is no residual change in the EUT or any change in outputs, which could be interpreted by associated equipment as a change, and no such flickering of indicators oeuvres at $U = 130 \text{ dB}\mu\text{V}$.

For component of CCTV systems, where the status is monitored by observing the TV picture, then deterioration of the picture is allowed at $U = 140 \text{ dB}\mu\text{V}$, providing:

(a) there is no permanent damage or change to the EUT

(e.g. no corruption of memory or changes to programmable settings etc.)

(b) at $U = 130 \text{ dB}\mu\text{V}$, any deterioration of the picture is so minor that the system could still be used; and

(c) there in no observable deterioration of the picture at $U = 120 \text{ dB}\mu\text{V}$.

Voltage dip/interruption / Voltage variation

There shall be no damage, malfunction or change of status due to the conditioning.

Flickering of an indicator during the conditioning is permissible, providing that there is no residual

change in the EUT or any change in outputs, which could be interpreted by associated equipment

as a change. The EUT shall meet the acceptance criteria for the functional test, after the conditioning.

3.1 Electrostatic Discharge

Reference Standard

EN 61000-4-2: 2009

Test Date

May. 10, 2016

Test Location

EMS-ESD: Electro wave Shieldroom

Test Equipment

Used	Description	Model Number	Manufacturer	Serial Number	Cal. Due
<input checked="" type="checkbox"/>	ESD SIMULATOR	ESS-2000	Noise Ken	ESS05X4620	02, 24, 2017
<input checked="" type="checkbox"/>	HCP	-	Noise Ken	-	-
<input checked="" type="checkbox"/>	VCP	-	Noise Ken	-	-

Test Conditions

Temperature: 23,7 °C
Relative Humidity: 49,2 %
Atmospheric Pressure: 98,9 kPa

Test Specifications

Discharge Factor: ≥ 1 s

Discharge Impedance: 330 ohm / 150 pF

Kind of Discharge: Air, Contact (direct and indirect)

Polarity: Positive and Negative

Number of Discharge: 10 at all locations for Air discharge
10 at all locations for Contact discharge

Discharge Voltage:	Contact	Air	HCP	VCP
	<input type="checkbox"/> 2 kV	<input checked="" type="checkbox"/> 2 kV	<input type="checkbox"/> 2 kV	<input type="checkbox"/> 2 kV
	<input type="checkbox"/> 4 kV	<input checked="" type="checkbox"/> 4 kV	<input type="checkbox"/> 4 kV	<input type="checkbox"/> 4 kV
	<input checked="" type="checkbox"/> 6 kV	<input type="checkbox"/> 6 kV	<input checked="" type="checkbox"/> 6 kV	<input checked="" type="checkbox"/> 6 kV
	<input type="checkbox"/> 8 kV	<input checked="" type="checkbox"/> 8 kV	<input type="checkbox"/> 8 kV	<input type="checkbox"/> 8 kV
	<input type="checkbox"/> 15 kV	<input type="checkbox"/> 15 kV	<input type="checkbox"/> 15 kV	<input type="checkbox"/> 15 kV

Notes: HCP: Horizontal coupling plane
VCP: Vertical coupling plane

Required Performance Criteria: Complied

This report shall not be reproduced except in full, without the written approval of KES Co., Ltd.
The results shown in this test report refer only to the sample(s) tested unless otherwise stated.

Location of Discharge:

- DC 12V, PoE Mode

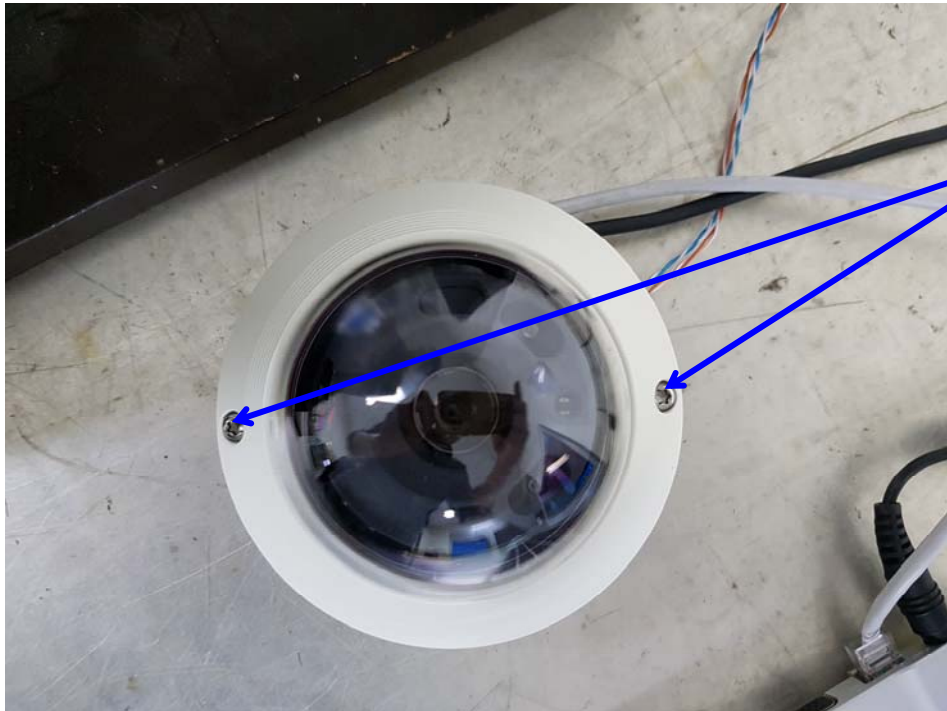
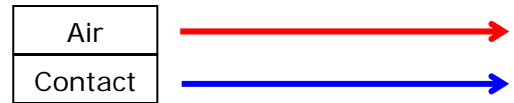

1. Contact

This report shall not be reproduced except in full, without the written approval of KES Co., Ltd.
The results shown in this test report refer only to the sample(s) tested unless otherwise stated.



Test Data

- DC 12V Mode

Indirect Discharge

No.	Test Point	Discharge Method	Performance	Remarks
			Observation	
1	HCP Contact	Contact Discharge	Complied	-
2	VCP Contact	Contact Discharge	Complied	-

Direct Discharge

No.	Test Point	Discharge Method	Performance	Remarks
			Observation	
1	Screw	Contact Discharge	Complied	-

- PoE Mode

Indirect Discharge

No.	Test Point	Discharge Method	Performance	Remarks
			Observation	
1	HCP Contact	Contact Discharge	Complied	-
2	VCP Contact	Contact Discharge	Complied	-

Direct Discharge

No.	Test Point	Discharge Method	Performance	Remarks
			Observation	
1	Screw	Contact Discharge	Complied	-

Note: "Blank" = Not performed

Observations:
Complied – No degradation of function

Test Results

- PASS Required Performance Criteria
- NOT PASS Required Performance Criteria

Remarks

PASS Required Performance Criteria.



3.2 Radiated Electric Field Immunity

Reference Standard

EN 61000-4-3:2006 +A2:2010

Test Date

May. 10, 2016

Test Location

EMS-RS: Semi Anchoic Chamber #1 Semi Anchoic Chamber #2

Test Equipment

Used	Description	Model Number	Manufacturer	Serial Number	Cal. Due
<input checked="" type="checkbox"/>	SIGNAL GENERATOR	SMB 100A	R&S	108252	08, 13, 2016
<input checked="" type="checkbox"/>	BROADBAND AMPLIFIER	BBA100	R&S	101239	08, 13, 2016
<input checked="" type="checkbox"/>	BROADBAND AMPLIFIER	100S1G6M1	AR	579931	08, 13, 2016
<input checked="" type="checkbox"/>	POWER METER	NRP2	R&S	103475	08, 13, 2016
<input checked="" type="checkbox"/>	AVG POWER SENSOR	NRP-Z91	R&S	102526	08, 13, 2016
<input checked="" type="checkbox"/>	AVG POWER SENSOR	NRP-Z91	R&S	102527	08, 13, 2016
<input checked="" type="checkbox"/>	Stacked Log.-Per.Antenna	STLP 9128 D	Schwarzbeck	9128D038	-
<input checked="" type="checkbox"/>	Semi Anchoic Chamber #2		SEMITEC	-	-



Test Conditions

Temperature: 23,7 °C
Relative Humidity: 49,2 %
Atmospheric Pressure: 98,9 kPa

Test Specifications

Antenna Polarization: Horizontal & vertical unless indicated otherwise

Antenna Distance: 3 m

Field Strength: 1 V/m 3 V/m
 10 V/m

Frequency Range: 80 MHz to 1 GHz 1,4 GHz to 2,7 GHz
 80 MHz to 2,7 GHz

Modulation: AM, 80 %, 1 kHz sine wave
 PM, 1 Hz (0,5 s ON : 0,5 s OFF)

Frequency step: 1 % step

Dwell Time: 1 s 3 s

of Sides Radiated: 4

Required Performance Criteria: Complied

Test Data

- DC 12V Mode

Side Exposed	Observation	
	Horizontal	Vertical
Front	Complied	Complied
Right	Complied	Complied
Back	Complied	Complied
Left	Complied	Complied



KES Co., Ltd.

C-3701, Simin-daero 365-40,
Dongan-gu, Anyang-si, Gyeonggi-do, 14057, Korea
Tel: +82-31-425-6200 / Fax: +82-31-424-0450
www.kes.co.kr

Test report No.:
KES-E1-16T0211
Page (24) of (76)

- PoE Mode

Side Exposed	Observation	
	Horizontal	Vertical
Front	Complied	Complied
Right	Complied	Complied
Back	Complied	Complied
Left	Complied	Complied

Note: "Blank" = Not performed

Observations:
Complied – No degradation of function

Test Results

- PASS Required Performance Criteria
- NOT PASS Required Performance Criteria

Remarks

PASS Required Performance Criteria.

This report shall not be reproduced except in full, without the written approval of KES Co., Ltd.
The results shown in this test report refer only to the sample(s) tested unless otherwise stated.

3.3 Electrical Fast Transients/Bursts

Reference Standard

EN 61000-4-4:2012

Test Date

May. 11, 2016

Test Location

EMS-EFT: Electro wave Shieldroom

Test Equipment

Used	Description	Model Number	Manufacturer	Serial Number	Cal. Due
<input checked="" type="checkbox"/>	Ultra Compact Simulator	UCS 500 N5	EM TEST	V0936105120	07, 14, 2016
<input checked="" type="checkbox"/>	Capacitive Coupling Clamp	HFK	EM TEST	070925	07, 14, 2016
<input checked="" type="checkbox"/>	MotorVariac	MV2616	EM TEST	V0936105123	07, 14, 2016

Test Conditions

Temperature: 22,7 °C
Relative Humidity: 47,0 %
Atmospheric Pressure: 99,1 kPa

Test Specifications

Pulse Amplitude & Polarity:
(Power Lines) ± 1.0 kV ± 2.0 kV
 ± 4.0 kV

Pulse Amplitude & Polarity:
(Signal Lines) ± 0.5 kV ± 1.0 kV
 ± 2.0 kV

Burst Period: 300 ms 2 s

Repetition Rate: 5 klz 100 klz

Duration of Test Voltage: ≥ 1 min

Required Performance Criteria: Complied

This report shall not be reproduced except in full, without the written approval of KES Co., Ltd.
The results shown in this test report refer only to the sample(s) tested unless otherwise stated.

Test Data

- DC 12V Mode

Input a.c. power ports – Coupling/Decoupling Network used

Mode of Application	OBSERVATIONS	
	(+) Burst (kV)	(-) Burst (kV)
-	-	-

Input d.c. power ports – Coupling/Decoupling Network used

Mode of Application	OBSERVATIONS	
	(+) Burst (kV)	(-) Burst (kV)
L – N	Complied	Complied

Signal ports and telecommunication ports – Coupling Clamp used

Mode of Application	OBSERVATIONS	
	(+) Burst (kV)	(-) Burst (kV)
RJ-45	Complied	Complied
Alarm IN	Complied	Complied

This report shall not be reproduced except in full, without the written approval of KES Co., Ltd.
 The results shown in this test report refer only to the sample(s) tested unless otherwise stated.



- PoE Mode

Input a.c. power ports – Coupling/Decoupling Network used

Mode of Application	OBSERVATIONS	
	(+) Burst (kV)	(-) Burst (kV)
-	-	-

Input d.c. power ports – Coupling/Decoupling Network used

Mode of Application	OBSERVATIONS	
	(+) Burst (kV)	(-) Burst (kV)
-	-	-

Signal ports and telecommunication ports – Coupling Clamp used

Mode of Application	OBSERVATIONS	
	(+) Burst (kV)	(-) Burst (kV)
RJ-45	Complied	Complied
Alarm IN	Complied	Complied

Note: "Blank" = Not performed

Observations:

- A – No degradation of function
- B – Distortion/Error of function (self-recoverable)
- C – Loss of function

Test Results

- PASS Required Performance Criteria
- NOT PASS Required Performance Criteria

Remarks

PASS Required Performance Criteria.

3.4 Surge Transients

Reference Standard

EN 61000-4-5: 2014

Test Date

May. 11, 2016

Test Location

EMS-Surge: Electro wave Shieldroom

Test Equipment

Used	Description	Model Number	Manufacturer	Serial Number	Cal. Due
<input checked="" type="checkbox"/>	Ultra Compact Simulator	UCS 500 N5	EM TEST	V0936105120	07, 14, 2016
<input checked="" type="checkbox"/>	MotorVariac	MV2616	EM TEST	V0936105123	07, 14, 2016
<input type="checkbox"/>	CDN	CNV 508T5	EM TEST	P1530162238	04, 01, 2016

Test Conditions

Temperature: 22,7 °C
Relative Humidity: 47,0 %
Atmospheric Pressure: 99,1 kPa

Test Specifications

Power Lines

Source Impedance: 12 ohm for common mode and 2 ohm for differential mode

Surge Amplitude :

Common Mode

(0,5 / 1,0 / 2,0) kV

Differential Mode

(0,5 / 1,0) kV

Signal lines

(0,5 / 1,0) kV

Number of Surges:

5 surges per angle

Angle:

0°, 90°, 180°, 270° (input a.c. power port)

Polarity:

Positive & Negative

Repetition Rate:

1 surge per min 1 surge per 30 sec.

Required Performance Criteria: Complied

This report shall not be reproduced except in full, without the written approval of KES Co., Ltd.
The results shown in this test report refer only to the sample(s) tested unless otherwise stated.



Signal Lines

Source Impedance: 42 ohm for common mode
Surge Amplitude: Common Mode
 (0,5 / 1,0) kV

Number of Surges: 5 Surges

Polarity: Positive & Negative

Repetition Rate: 1 surge per min 1 surge per 30 sec.

Required Performance Criteria: Complied

Test Data

- DC 12V Mode

Line to Line – Differential Mode

Mode of Application	OBSERVATIONS	
	(+) Surge (kV)	(-) Surge (kV)
-	-	-

Line to Earth – Common Mode

Mode of Application	OBSERVATIONS	
	(+) Surge (kV)	(-) Surge (kV)
-	-	-

Signal Lines

Line to Earth – Common Mode

Mode of Application	OBSERVATIONS	
	(+) Surge (kV)	(-) Surge (kV)
RJ-45	Complied	Complied
Alarm IN	Complied	Complied



- PoE Mode

Line to Line – Differential Mode

Mode of Application	OBSERVATIONS	
	(+) Surge (kV)	(-) Surge (kV)
-	-	-

Line to Earth – Common Mode

Mode of Application	OBSERVATIONS	
	(+) Surge (kV)	(-) Surge (kV)
-	-	-

Signal Lines

Line to Earth – Common Mode

Mode of Application	OBSERVATIONS	
	(+) Surge (kV)	(-) Surge (kV)
RJ-45	Complied	Complied
Alarm IN	Complied	Complied

Note: "Blank" = Not performed

Observations:

- A – No degradation of function
- B – Distortion/Error of function (self-recoverable)
- C – Loss of function

Test Results

- PASS Required Performance Criteria
- NOT PASS Required Performance Criteria

Remarks

PASS Required Performance Criteria.

3.5 Conducted Disturbance

Reference Standard

EN 61000-4-6:2009

Test Date

May. 11, 2016

Test Location

EMS-CS: Electro wave Shieldroom

Test Equipment

Used	Description	Model Number	Manufacturer	Serial Number	Cal. Due
<input checked="" type="checkbox"/>	Continuous Wave Generator	CWS 500N1	EM TEST	V0936105119	09, 25, 2016
<input checked="" type="checkbox"/>	6dB Attenuator	ATT6	EM TEST	1208-34	08, 13, 2016
<input checked="" type="checkbox"/>	CDN	CDN-M2/M3N	EM TEST	0909-06	08, 13, 2016
<input type="checkbox"/>	CDN	CDN-T2-RJ11	EM TEST	0909-07	08, 13, 2016
<input type="checkbox"/>	CDN	CDN-T4	EM TEST	0909-08	08, 13, 2016
<input type="checkbox"/>	CDN	CDN-T8RJ45	EM TEST	0909-09	08, 13, 2016
<input type="checkbox"/>	CDN	CDN-AF2	EM TEST	0909-10	08, 13, 2016
<input type="checkbox"/>	CDN	CDN-AF4	EM TEST	0909-11	08, 13, 2016
<input checked="" type="checkbox"/>	EM Injection Clamp	EM 101	Liithi	35943	02, 04, 2017

Test Conditions

Temperature: 22,7 °C
Relative Humidity: 47,0 %
Atmospheric Pressure: 99,1 kPa



Test Specifications

- Frequency range: 150 kHz to 100 MHz 10 kHz to 30 MHz
 150 kHz to 230 MHz 10 kHz to 100 MHz
- Voltage Level: 1 Vrms 3 Vrms
 10 Vrms
- Modulation: AM, 80 %, 1 kHz sine wave
 PM, 1 Hz (0,5 s ON : 0,5 s OFF)
- Frequency step: 1 % step
- Dwell Time: 1 s 3 s
- Required Performance Criteria: Complied

Test Data

- DC 12V Mode

Input a.c. power ports

Coupling Location (Line Stressed)	Coupling Method	Observation
-	CDN (<input type="checkbox"/> M2, <input type="checkbox"/> M3)	-

Input d.c. power ports

Coupling Location (Line Stressed)	Coupling Method	Observation
L – N	CDN (<input checked="" type="checkbox"/> M2, <input type="checkbox"/> M3)	Complied

Signal ports and telecommunication ports

Mode of Application	OBSERVATIONS	
	(+) Surge (kV)	(-) Surge (kV)
RJ-45	Complied	Complied
Alarm IN	Complied	Complied

This report shall not be reproduced except in full, without the written approval of KES Co., Ltd.
The results shown in this test report refer only to the sample(s) tested unless otherwise stated.

- PoE Mode

Input a.c. power ports

Coupling Location (Line Stressed)	Coupling Method	Observation
-	CDN (<input type="checkbox"/> M2, <input type="checkbox"/> M3)	-

Input d.c. power ports

Coupling Location (Line Stressed)	Coupling Method	Observation
-	CDN (<input type="checkbox"/> M2, <input type="checkbox"/> M3)	-

Signal ports and telecommunication ports

Mode of Application	OBSERVATIONS	
	(+) Surge (kV)	(-) Surge (kV)
RJ-45	Complied	Complied
Alarm IN	Complied	Complied

Notes: CDN = Coupling Decoupling Network
 EMC = Electro Magnetic Clamp
 "blank" = Not performed

Observations:

- A – No degradation of function
- B – Distortion/Error of function (self-recoverable)
- C – Loss of function

Test Results

- PASS Required Performance Criteria
- NOT PASS Required Performance Criteria

Remarks

PASS Required Performance Criteria.



3.6 Voltage Dips and Short Interruptions

Reference Standard

EN 61000-4-6: 2009

Test Date

N/A

Test Location

EMS-Voltage dip: Electro wave Shieldroom

Test Equipment

Used	Description	Model Number	Manufacturer	Serial Number	Cal. Due
<input type="checkbox"/>	Ultra Compact Simulator	UCS 500 N5	EM TEST	V0936105120	07, 14, 2016
<input type="checkbox"/>	MotorVariac	MV2616	EM TEST	V0936105123	07, 14, 2016

Test Conditions

Temperature: °C
Relative Humidity: %
Atmospheric Pressure: kPa

This report shall not be reproduced except in full, without the written approval of KES Co., Ltd.
The results shown in this test report refer only to the sample(s) tested unless otherwise stated.



Test Specifications & Observations/Remarks

<u>Test Level</u>	<u>Duration [in period/ms (50 Hz)]</u>	<u>Results</u>
<input type="checkbox"/> 20 % dip	<input type="checkbox"/> 250 /10	_____
<input type="checkbox"/> 30 % dip	<input type="checkbox"/> 25 /10	_____
<input type="checkbox"/> 60 % dip	<input type="checkbox"/> 10 /10	_____
<input type="checkbox"/> 100 % dip	<input type="checkbox"/> 250 /10	_____

- Voltage variations

<input type="checkbox"/> Unom + 10 %	<input type="checkbox"/> 253 V (ac)	_____
<input type="checkbox"/> Unom - 15 %	<input type="checkbox"/> 195.5 V (ac)	_____

Observations:

- A – No response observed from E.U.T
- B – Unit shuts down then automatically restarts when full voltage is restored.
- C – Unit shuts down then manually restarts when full voltage is restored or Loss of function.

Test Results

- PASS Required Performance Criteria
- NOT PASS Required Performance Criteria
- NOT APPLICABLE

Remarks

Because the E.U.T power is 12 V (dc) power and PoE.



KES Co., Ltd.

C-3701, Simin-daero 365-40,
Dongan-gu, Anyang-si, Gyeonggi-do, 14057, Korea
Tel: +82-31-425-6200 / Fax: +82-31-424-0450
www.kes.co.kr

Test report No.:
KES-E1-16T0211
Page (36) of (76)

APPENDIX A – TEST DATA

Conducted Emissions at Mains Power Ports

[HOT]

N/A

This report shall not be reproduced except in full, without the written approval of KES Co., Ltd.
The results shown in this test report refer only to the sample(s) tested unless otherwise stated.



KES Co., Ltd.

C-3701, Simin-daero 365-40,
Dongan-gu, Anyang-si, Gyeonggi-do, 14057, Korea
Tel: +82-31-425-6200 / Fax: +82-31-424-0450
www.kes.co.kr

Test report No.:
KES-E1-16T0211
Page (37) of (76)

[NEUTRAL]

N/A

This report shall not be reproduced except in full, without the written approval of KES Co., Ltd.
The results shown in this test report refer only to the sample(s) tested unless otherwise stated.

Conducted Emissions at Telecommunication Ports

- DC 12V Mode

[10 Mbps]

Common Information

Test Description:	Telecommunication Emission
Model No.:	QNV-7030RP
Mode	10 Mbps
Operator Name:	KES

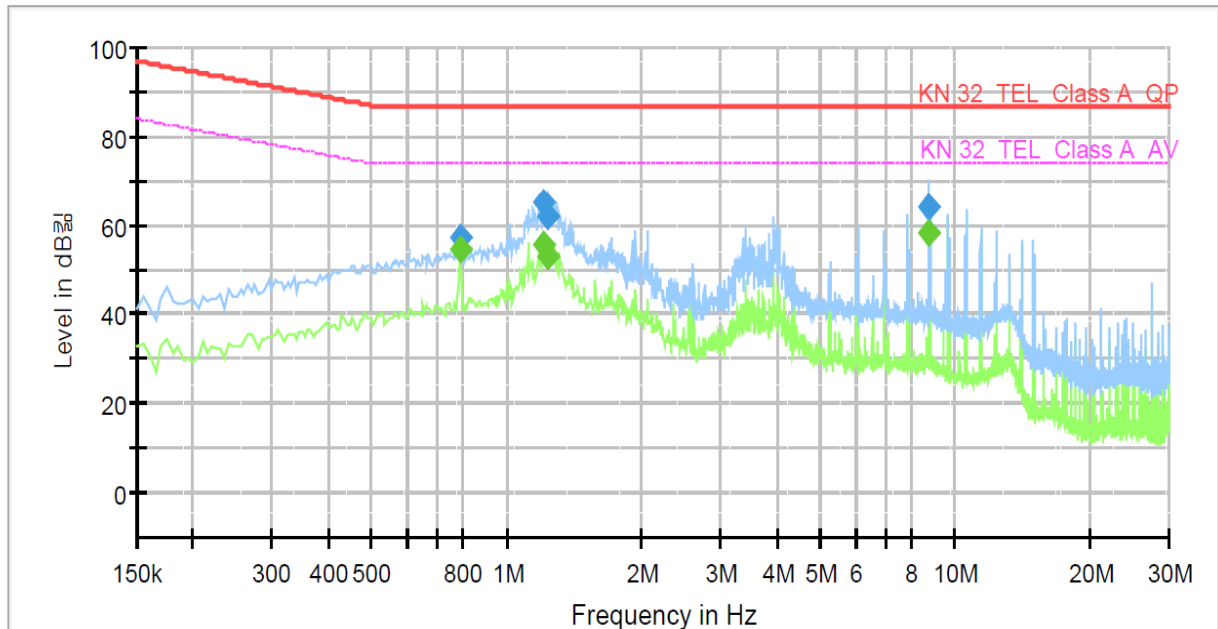

Final Result

Frequency (MHz)	QuasiPeak (dBμV)	CAverage (dBμV)	Limit (dBμV)	Margin (dB)	Meas. Time (ms)	Bandwidth (kHz)	Line	Corr. (dB)
0.785000	---	54.69	74.00	19.31	1000.0	9.000	Single Line	9.9
0.785000	57.37	---	87.00	29.63	1000.0	9.000	Single Line	9.9
1.215000	---	55.47	74.00	18.53	1000.0	9.000	Single Line	9.8
1.215000	65.17	---	87.00	21.83	1000.0	9.000	Single Line	9.8
1.230000	---	52.68	74.00	21.32	1000.0	9.000	Single Line	9.8
1.230000	61.71	---	87.00	25.29	1000.0	9.000	Single Line	9.8
8.750000	---	58.02	74.00	15.98	1000.0	9.000	Single Line	10.0
8.750000	64.18	---	87.00	22.82	1000.0	9.000	Single Line	10.0

This report shall not be reproduced except in full, without the written approval of KES Co., Ltd.
The results shown in this test report refer only to the sample(s) tested unless otherwise stated.

[100 Mbps]

Common Information

Test Description: Telecommunication Emission
 Model No.: QNV-7030RP
 Mode: 100 Mbps
 Operator Name: KES

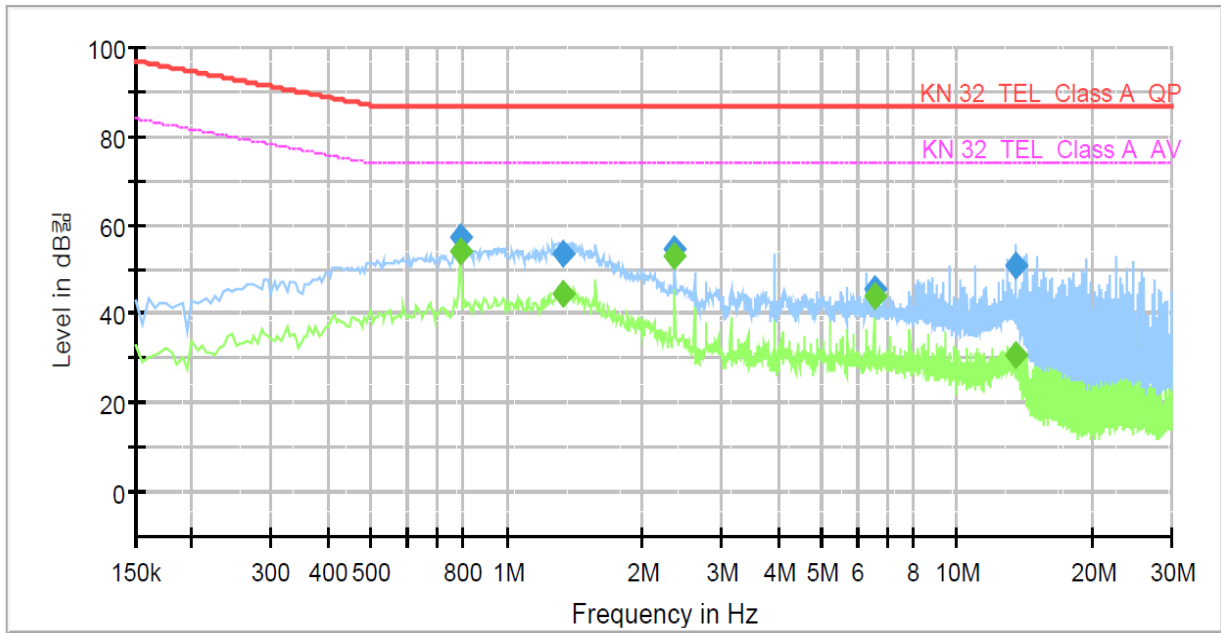

Final Result

Frequency (MHz)	QuasiPeak (dBμV)	CAverage (dBμV)	Limit (dBμV)	Margin (dB)	Meas. Time (ms)	Bandwidth (kHz)	Line	Corr. (dB)
0.785000	---	54.18	74.00	19.82	1000.0	9.000	Single Line	9.4
0.785000	57.12	---	87.00	29.88	1000.0	9.000	Single Line	9.4
1.330000	---	44.29	74.00	29.71	1000.0	9.000	Single Line	9.3
1.330000	53.61	---	87.00	33.39	1000.0	9.000	Single Line	9.3
2.360000	---	53.16	74.00	20.84	1000.0	9.000	Single Line	9.3
2.360000	54.36	---	87.00	32.64	1000.0	9.000	Single Line	9.3
6.545000	---	43.80	74.00	30.20	1000.0	9.000	Single Line	9.5
6.545000	45.73	---	87.00	41.27	1000.0	9.000	Single Line	9.5
13.555000	---	30.56	74.00	43.44	1000.0	9.000	Single Line	9.6
13.555000	50.80	---	87.00	36.20	1000.0	9.000	Single Line	9.6

This report shall not be reproduced except in full, without the written approval of KES Co., Ltd.
 The results shown in this test report refer only to the sample(s) tested unless otherwise stated.

- PoE Mode

[10 Mbps]

Common Information

Test Description: Telecommunication Emission
 Model No.: QNV-7030RP
 Mode: 10 Mbps
 Operator Name: KES

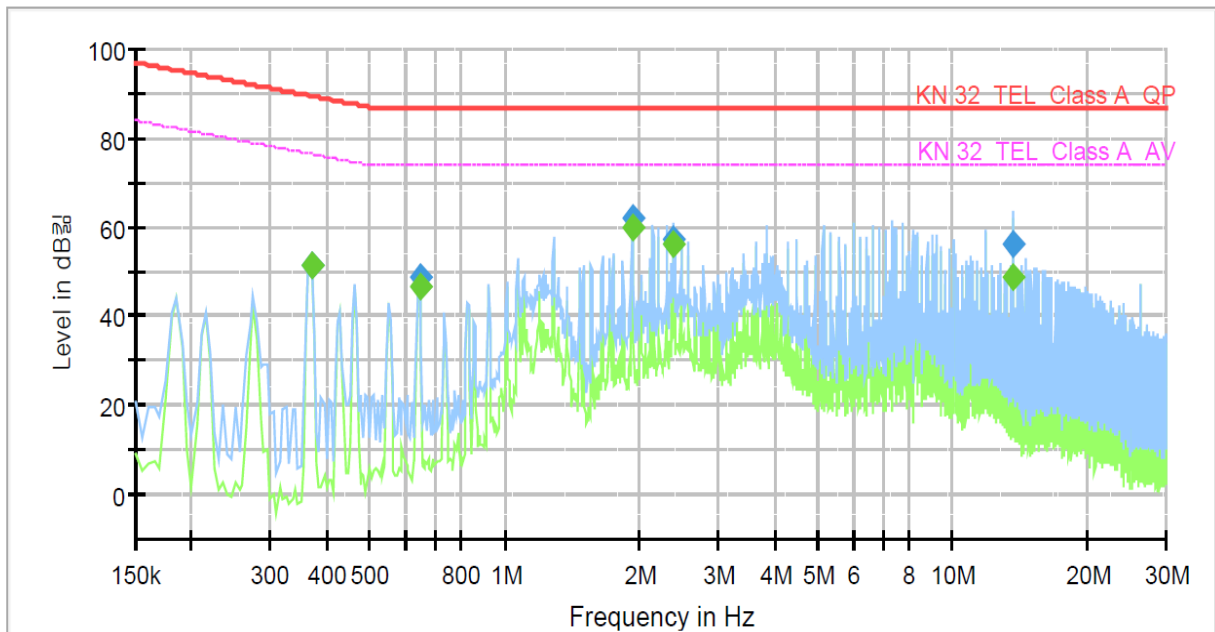

Final Result

Frequency (MHz)	QuasiPeak (dBm)	CAverage (dBm)	Limit (dBm)	Margin (dB)	Meas. Time (ms)	Bandwidth (kHz)	Line	Corr. (dB)
0.370000	---	51.15	76.50	25.35	1000.0	9.000	Single Line	10.0
0.370000	51.19	---	89.50	38.31	1000.0	9.000	Single Line	10.0
0.645000	---	46.39	74.00	27.61	1000.0	9.000	Single Line	9.9
0.645000	48.47	---	87.00	38.53	1000.0	9.000	Single Line	9.9
1.930000	---	60.07	74.00	13.93	1000.0	9.000	Single Line	9.8
1.930000	61.73	---	87.00	25.27	1000.0	9.000	Single Line	9.8
2.390000	---	56.13	74.00	17.87	1000.0	9.000	Single Line	9.8
2.390000	57.21	---	87.00	29.79	1000.0	9.000	Single Line	9.8
13.695000	---	48.86	74.00	25.14	1000.0	9.000	Single Line	10.1
13.695000	56.08	---	87.00	30.92	1000.0	9.000	Single Line	10.1

This report shall not be reproduced except in full, without the written approval of KES Co., Ltd.
 The results shown in this test report refer only to the sample(s) tested unless otherwise stated.

[100 Mbps]

Common Information

Test Description:	Telecommunication Emission
Model No.:	QNV-7030RP
Mode	100 Mbps
Operator Name:	KES

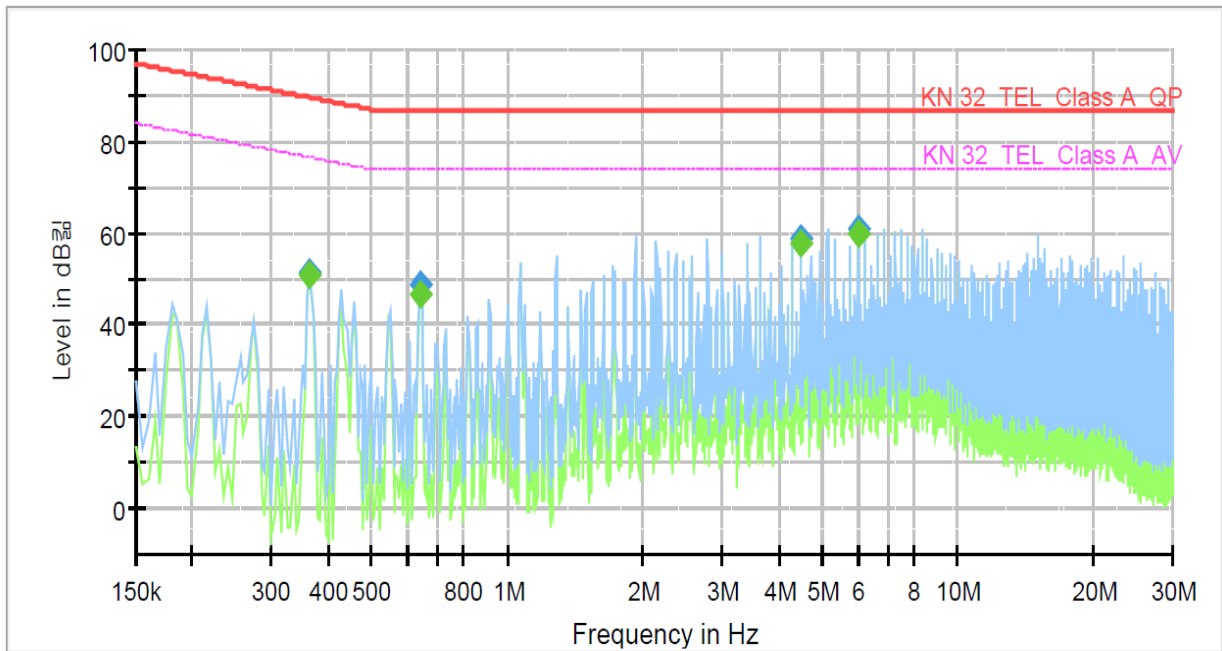

Final Result

Frequency (MHz)	QuasiPeak (dBμV)	CAverage (dBμV)	Limit (dBμV)	Margin (dB)	Meas. Time (ms)	Bandwidth (kHz)	Line	Corr. (dB)
0.365000	---	51.03	76.61	25.58	1000.0	9.000	Single Line	9.5
0.365000	51.15	---	89.61	38.46	1000.0	9.000	Single Line	9.5
0.640000	---	46.68	74.00	27.32	1000.0	9.000	Single Line	9.4
0.640000	48.89	---	87.00	38.11	1000.0	9.000	Single Line	9.4
4.495000	---	57.75	74.00	16.25	1000.0	9.000	Single Line	9.3
4.495000	58.64	---	87.00	28.36	1000.0	9.000	Single Line	9.3
5.995000	---	60.00	74.00	14.00	1000.0	9.000	Single Line	9.4
5.995000	60.76	---	87.00	26.24	1000.0	9.000	Single Line	9.4

This report shall not be reproduced except in full, without the written approval of KES Co., Ltd.
The results shown in this test report refer only to the sample(s) tested unless otherwise stated.



Radiated Electric Field Emissions(Below 1 GHz)

- DC 12V Mode

Frequency [MHz]	Amplitude [dB μ V]	ANT Polar. (H/V)	ANT. Height [m]	Correction Factor		Corrected Amplitude [dB μ V/m]	Applicable Limit [dB μ V/m]	Margin [dB]
				ANT. [dB/m]	Cable [dB]			
68.24	7.13	V	1.00	10.21	1.73	19.07	40.00	20.93
168.33	7.86	H	4.00	8.91	2.93	19.70	40.00	20.30
264.19	12.47	V	1.00	12.69	3.92	29.08	47.00	17.92
311.99	14.57	H	3.50	13.66	4.32	32.55	47.00	14.45
408.75	11.04	V	1.00	15.82	5.10	31.96	47.00	15.04
455.99	15.74	H	3.25	16.48	5.44	37.66	47.00	9.34

* H : Horizontal, V : Vertical

- PoE Mode

Frequency [MHz]	Amplitude [dB μ V]	ANT Polar. (H/V)	ANT. Height [m]	Correction Factor		Corrected Amplitude [dB μ V/m]	Applicable Limit [dB μ V/m]	Margin [dB]
				ANT. [dB/m]	Cable [dB]			
49.71	9.67	V	1.00	13.94	1.45	25.06	40.00	14.94
360.18	10.30	H	4.00	14.78	4.74	29.82	47.00	17.18
408.22	7.14	V	1.00	15.82	5.10	28.06	47.00	18.94
455.96	12.77	H	3.40	16.48	5.44	34.69	47.00	12.31
480.85	6.56	V	1.00	16.83	5.61	29.00	47.00	18.00
594.74	7.05	H	4.00	19.18	6.29	32.52	47.00	14.48

* H : Horizontal, V : Vertical

Radiated Electric Field Emissions(Above 1 GHz)

- DC 12V Mode

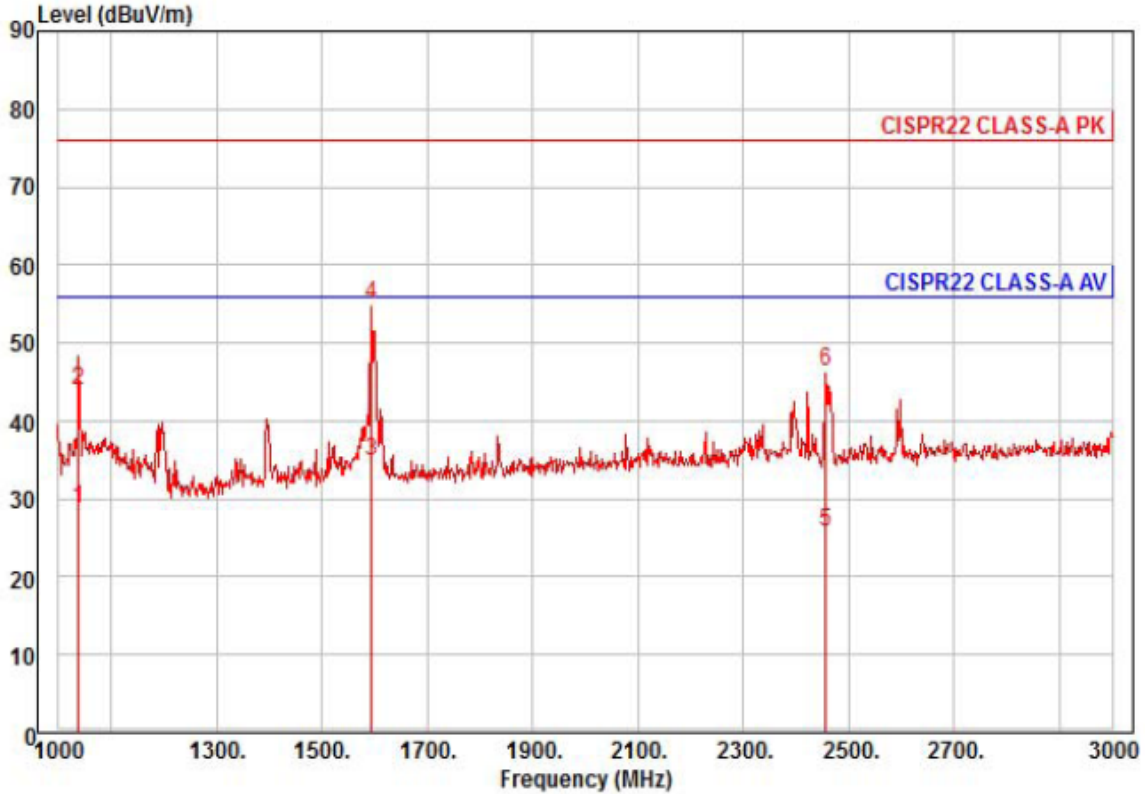

Site : chamber
 Condition: CISPR22 CLASS-A PK 3m HORN781(2015.05.07) horizontal
 : RBW:1000.000kHz VBW:1000.000kHz SWT:Auto
 Project :
 Model : QNV-7030RP
 Mode : DC 12V
 Memo :

	Read Freq	Level	Ant Factor	Cable Loss	Preamp Factor	TPos	Limit Line	Over Limit	Pol/Phase	Remark
	MHz	dBuV	dB/m	dB	dB	deg	dBuV/m	dB		
1	1038.00	38.01	24.06	6.62	40.10	216	56.00	-27.41	horizontal	Average
2	1038.00	53.31	24.06	6.62	40.10	216	76.00	-32.11	horizontal	Peak
3 av	1594.00	40.07	26.27	8.23	39.83	88	56.00	-21.26	horizontal	Average
4 pp	1594.00	60.15	26.27	8.23	39.83	88	76.00	-21.18	horizontal	Peak
5	2456.00	26.58	29.00	10.05	39.89	88	56.00	-30.26	horizontal	Average
6	2456.00	47.20	29.00	10.05	39.89	88	76.00	-29.64	horizontal	Peak

This report shall not be reproduced except in full, without the written approval of KES Co., Ltd.
 The results shown in this test report refer only to the sample(s) tested unless otherwise stated.

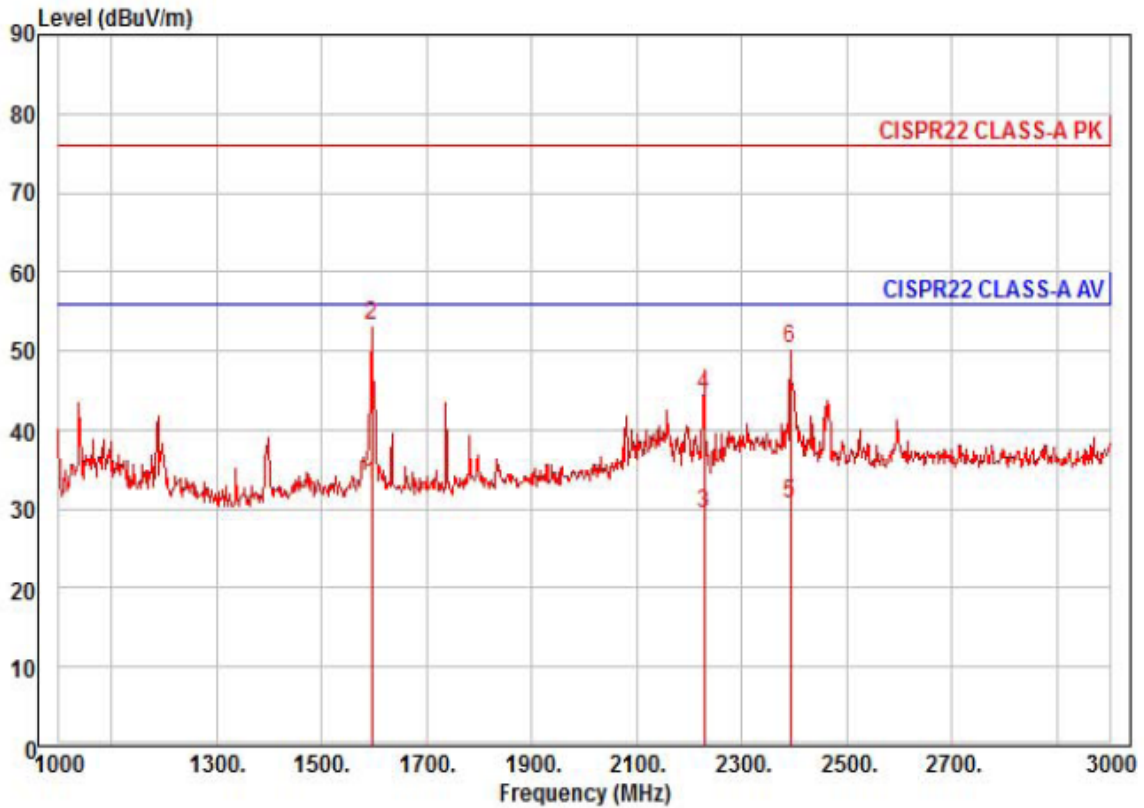

Site : chamber
 Condition: CISPR22 CLASS-A PK 3m HORN781(2015.05.07) vertical
 : RBW:1000.000kHz VBW:1000.000kHz SWT:Auto
 Project :
 Model : QNV-7030RP
 Mode : DC 12V
 Memo :

		Read	Ant	Cable	Preamp	TPos	Limit	Over			
	Freq	Level	Factor	Loss	Factor		Line	Limit	Pol/Phase	Remark	
	MHz	dBuV	dB/m	dB	dB	deg	dBuV/m	dB			
1	av	1596.00	38.51	26.28	8.24	39.83	41	56.00	-22.80	vertical	Average
2	pp	1596.00	58.52	26.28	8.24	39.83	41	76.00	-22.79	vertical	Peak
3		2228.00	31.16	28.44	9.70	39.76	238	56.00	-26.46	vertical	Average
4		2228.00	45.99	28.44	9.70	39.76	238	76.00	-31.63	vertical	Peak
5		2392.00	31.71	28.84	9.95	39.86	215	56.00	-25.36	vertical	Average
6		2392.00	51.35	28.84	9.95	39.86	215	76.00	-25.72	vertical	Peak

This report shall not be reproduced except in full, without the written approval of KES Co., Ltd.
 The results shown in this test report refer only to the sample(s) tested unless otherwise stated.

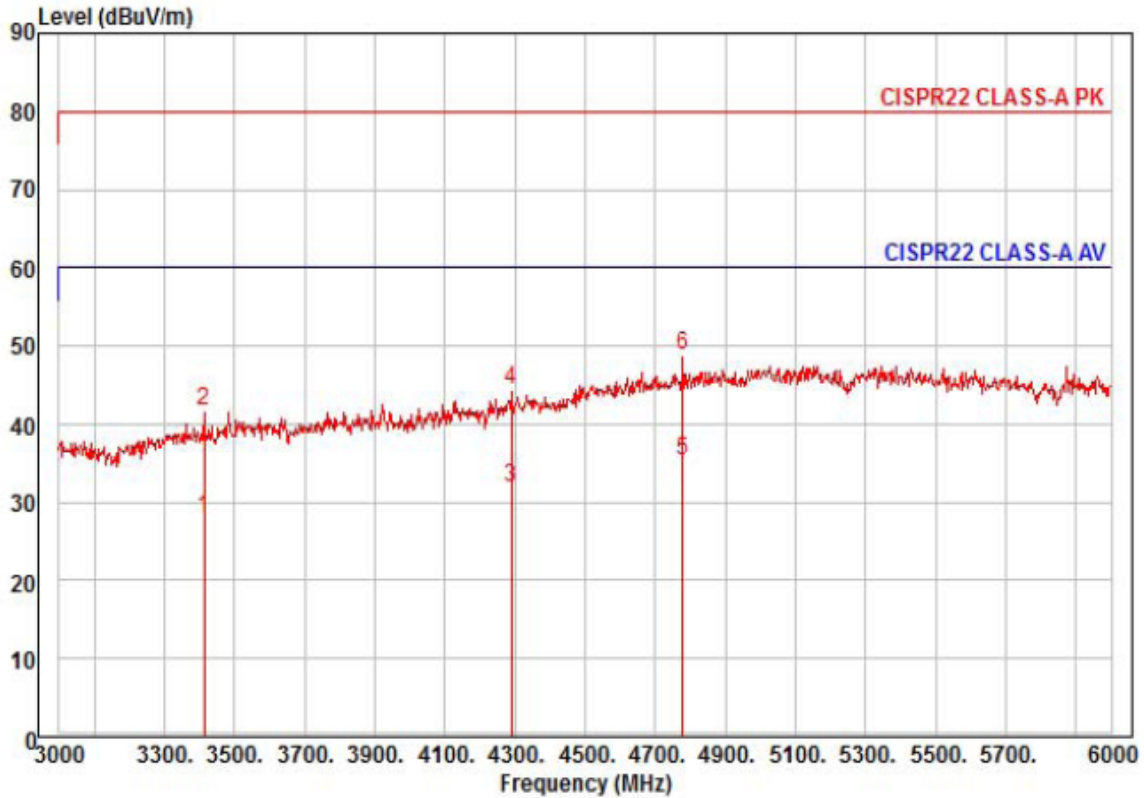

Site : chamber
 Condition: CISPR22 CLASS-A PK 3m HORN781(2015.05.07) horizontal
 : RBW:1000.000kHz VBW:1000.000kHz SWT:Auto
 Project :
 Model : QNV-7030RP
 Mode : DC 12V
 Memo :

	Freq	Read Level	Ant Factor	Cable Loss	Preamp Factor	TPos	Limit Line	Over Limit	Pol/Phase	Remark
	MHz	dBuV	dB/m	dB	dB	deg	dBuV/m	dB		
1	3414.00	24.94	31.03	12.29	40.29	194	60.00	-32.03	horizontal	Average
2	3414.00	38.57	31.03	12.29	40.29	194	80.00	-38.40	horizontal	Peak
3	4290.00	24.47	33.67	14.04	40.41	78	60.00	-28.23	horizontal	Average
4	4290.00	37.12	33.67	14.04	40.41	78	80.00	-35.58	horizontal	Peak
5 pp	4779.00	24.29	36.46	14.93	40.41	191	60.00	-24.73	horizontal	Average
6 pk	4779.00	37.77	36.46	14.93	40.41	191	80.00	-31.25	horizontal	Peak

This report shall not be reproduced except in full, without the written approval of KES Co., Ltd.
 The results shown in this test report refer only to the sample(s) tested unless otherwise stated.

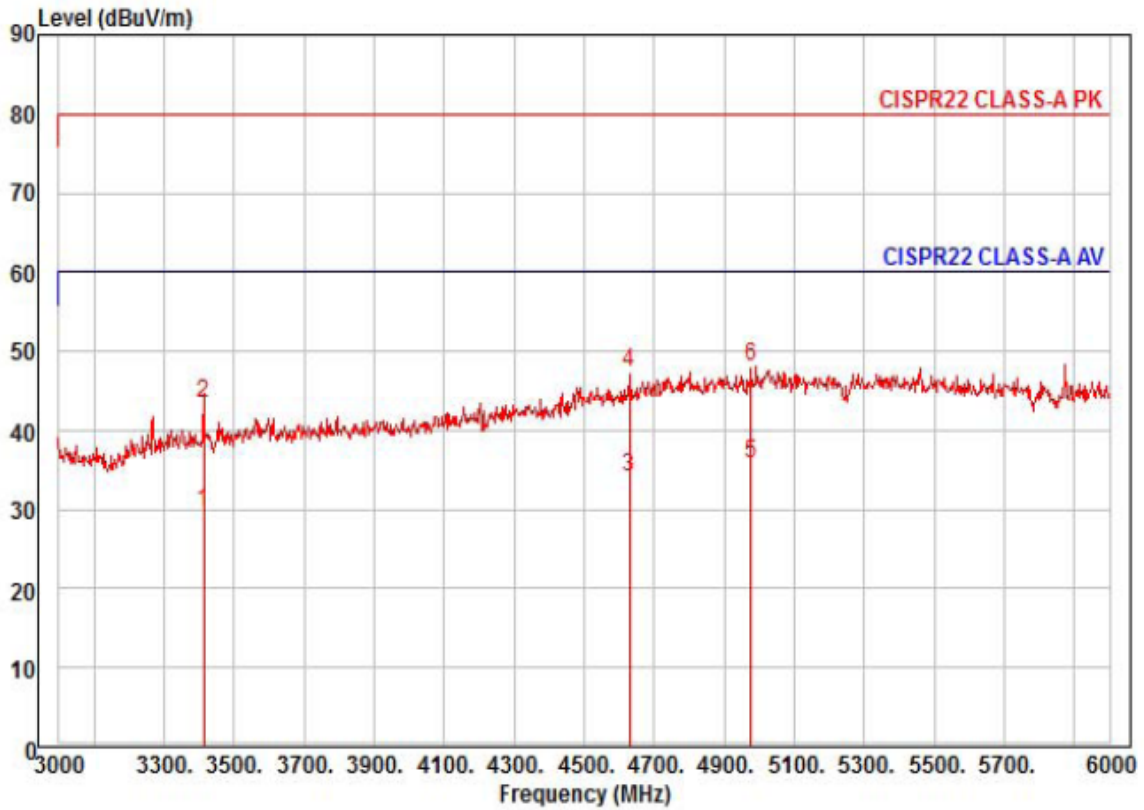

Site : chamber
 Condition: CISPR22 CLASS-A PK 3m HORN781(2015.05.07) vertical
 : RBW:1000.000kHz VBW:1000.000kHz SWT:Auto
 Project :
 Model : QNV-7030RP
 Mode : DC 12V
 Memo :

	Read Freq	Level	Ant Factor	Cable Loss	Preamp Factor	TPos	Limit Line	Over Limit	Pol/Phase	Remark
	MHz	dBuV	dB/m	dB	dB	deg	dBuV/m	dB		
1	3414.00	26.71	31.03	12.29	40.29	328	60.00	-30.26	vertical	Average
2	3414.00	40.42	31.03	12.29	40.29	328	80.00	-36.55	vertical	Peak
3	4629.00	24.28	35.60	14.66	40.41	14	60.00	-25.87	vertical	Average
4	4629.00	37.41	35.60	14.66	40.41	14	80.00	-32.74	vertical	Peak
5 pp	4977.00	23.35	37.59	15.29	40.41	325	60.00	-24.18	vertical	Average
6 pk	4977.00	35.64	37.59	15.29	40.41	325	80.00	-31.89	vertical	Peak

This report shall not be reproduced except in full, without the written approval of KES Co., Ltd.
 The results shown in this test report refer only to the sample(s) tested unless otherwise stated.

- PoE Mode

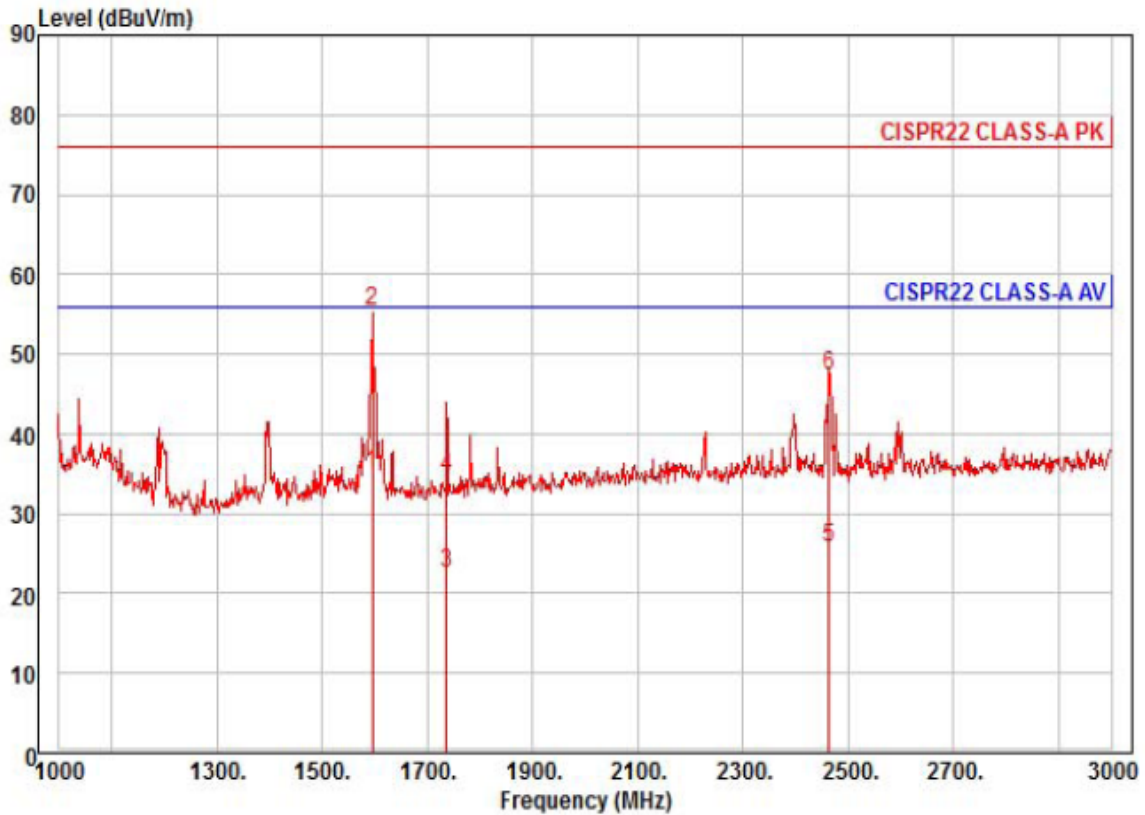

Site : chamber
 Condition: CISPR22 CLASS-A PK 3m HORN781(2015.05.07) horizontal
 : RBW:1000.000kHz VBW:1000.000kHz SWT:Auto
 Project :
 Model : QNV-7030RP
 Mode : PoE
 Memo :

		Read	Ant	Cable	Preamp	TPos	Limit	Over		
	Freq	Level	Factor	Loss	Factor		Line	Limit	Pol/Phase	Remark
	MHz	dBuV	dB/m	dB	dB	deg	dBuV/m	dB		
1	av	1596.00	40.44	26.28	8.24	39.83	93	56.00	-20.87	horizontal Average
2	pp	1596.00	60.65	26.28	8.24	39.83	93	76.00	-20.66	horizontal Peak
3		1736.00	26.82	26.83	8.62	39.76	325	56.00	-33.49	horizontal Average
4		1736.00	38.91	26.83	8.62	39.76	325	76.00	-41.40	horizontal Peak
5		2464.00	26.52	29.02	10.06	39.90	192	56.00	-30.30	horizontal Average
6		2464.00	48.27	29.02	10.06	39.90	192	76.00	-28.55	horizontal Peak

This report shall not be reproduced except in full, without the written approval of KES Co., Ltd.
 The results shown in this test report refer only to the sample(s) tested unless otherwise stated.

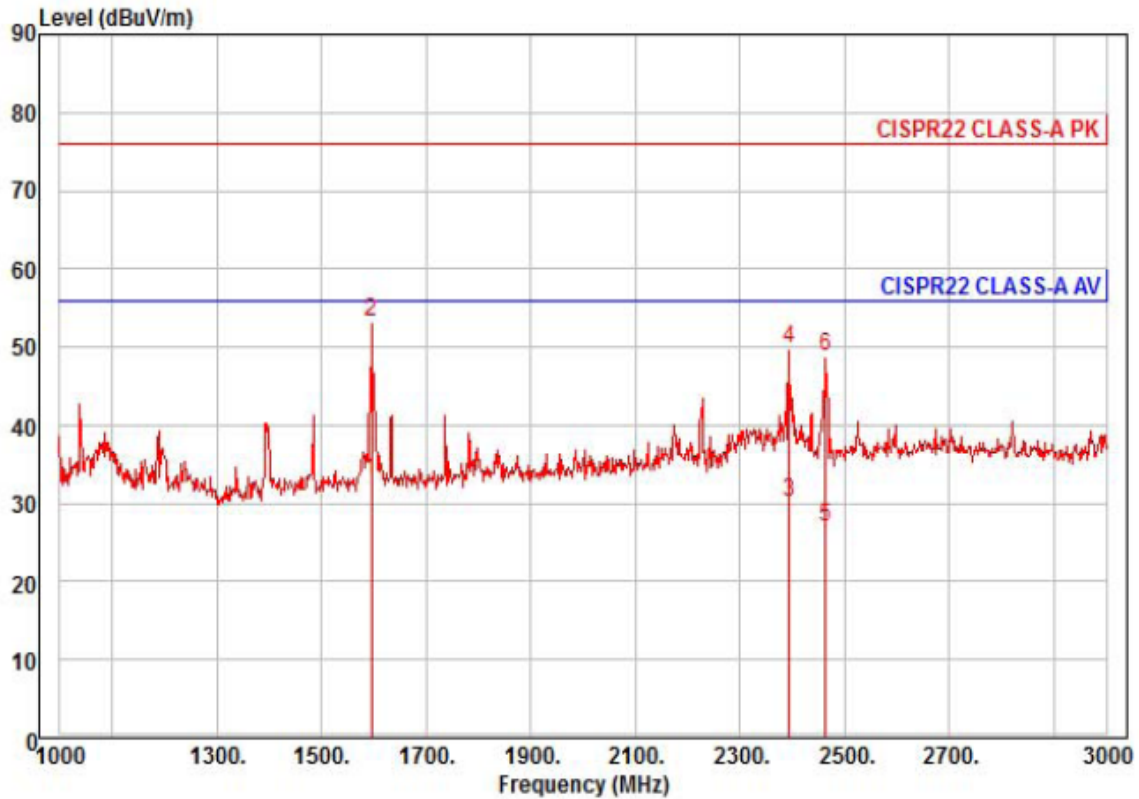

Site : chamber
 Condition: CISPR22 CLASS-A PK 3m HORN781(2015.05.07) vertical
 : RBW:1000.000kHz VBW:1000.000kHz SWT:Auto
 Project :
 Model : QNV-7030RP
 Mode : PoE
 Memo :

		Read	Ant	Cable	Preamp	TPos	Limit	Over			
	Freq	Level	Factor	Loss	Factor		Line	Limit	Pol/Phase	Remark	
	MHz	dBuV	dB/m	dB	dB	deg	dBuV/m	dB			
1	av	1596.00	38.11	26.28	8.24	39.83	50	56.00	-23.20	vertical	Average
2	pp	1596.00	58.43	26.28	8.24	39.83	50	76.00	-22.88	vertical	Peak
3		2394.00	31.16	28.85	9.95	39.86	229	56.00	-25.90	vertical	Average
4		2394.00	50.75	28.85	9.95	39.86	229	76.00	-26.31	vertical	Peak
5		2464.00	27.73	29.02	10.06	39.90	200	56.00	-29.09	vertical	Average
6		2464.00	49.56	29.02	10.06	39.90	200	76.00	-27.26	vertical	Peak

This report shall not be reproduced except in full, without the written approval of KES Co., Ltd.
 The results shown in this test report refer only to the sample(s) tested unless otherwise stated.

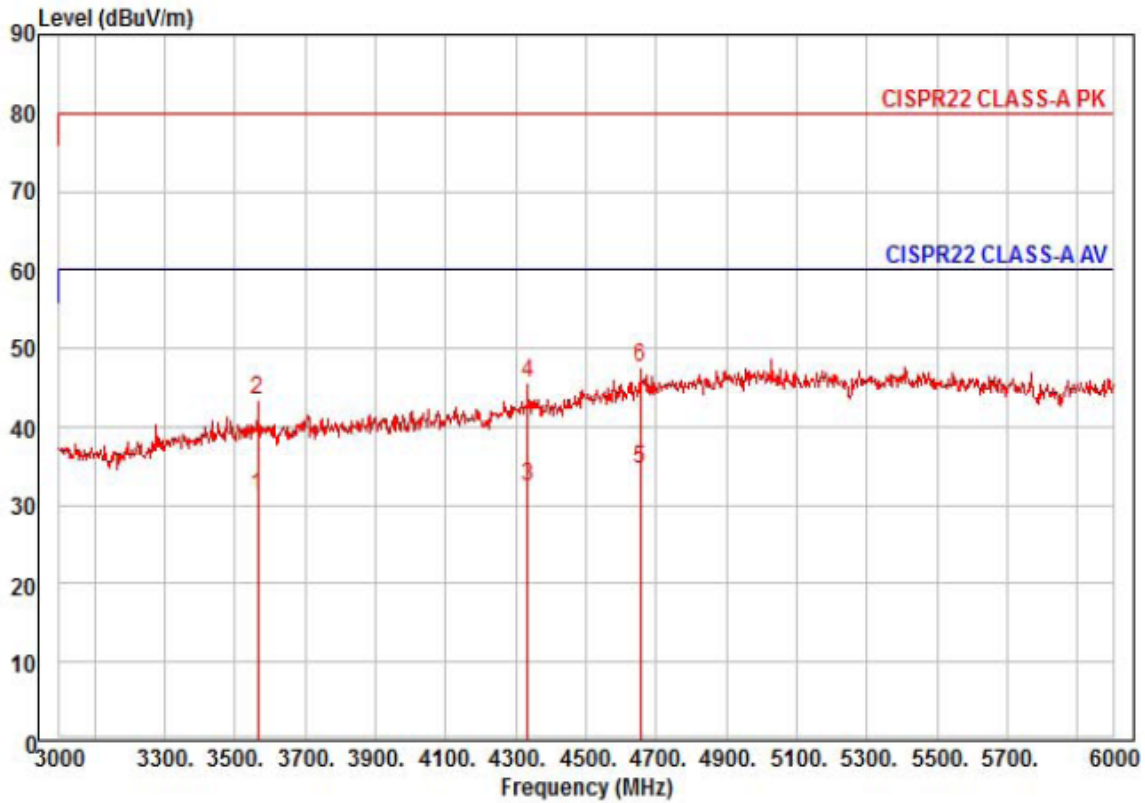

Site : chamber
 Condition: CISPR22 CLASS-A PK 3m HORN781(2015.05.07) horizontal
 : RBW:1000.000kHz VBW:1000.000kHz SWT:Auto
 Project :
 Model : QNV-7030RP
 Mode : PoE
 Memo :

	Freq	Read Level	Ant Factor	Cable Loss	Preamp Factor	TPos	Limit Line	Over Limit	Pol/Phase	Remark
	MHz	dBuV	dB/m	dB	dB	deg	dBuV/m	dB		
1	3564.00	27.61	31.28	12.64	40.32	36	60.00	-28.79	horizontal	Average
2	3564.00	39.87	31.28	12.64	40.32	36	80.00	-36.53	horizontal	Peak
3	4335.00	24.73	33.92	14.13	40.41	316	60.00	-27.63	horizontal	Average
4	4335.00	37.91	33.92	14.13	40.41	316	80.00	-34.45	horizontal	Peak
5 pp	4656.00	24.44	35.76	14.71	40.41	354	60.00	-25.50	horizontal	Average
6 pk	4656.00	37.59	35.76	14.71	40.41	354	80.00	-32.35	horizontal	Peak

This report shall not be reproduced except in full, without the written approval of KES Co., Ltd.
 The results shown in this test report refer only to the sample(s) tested unless otherwise stated.

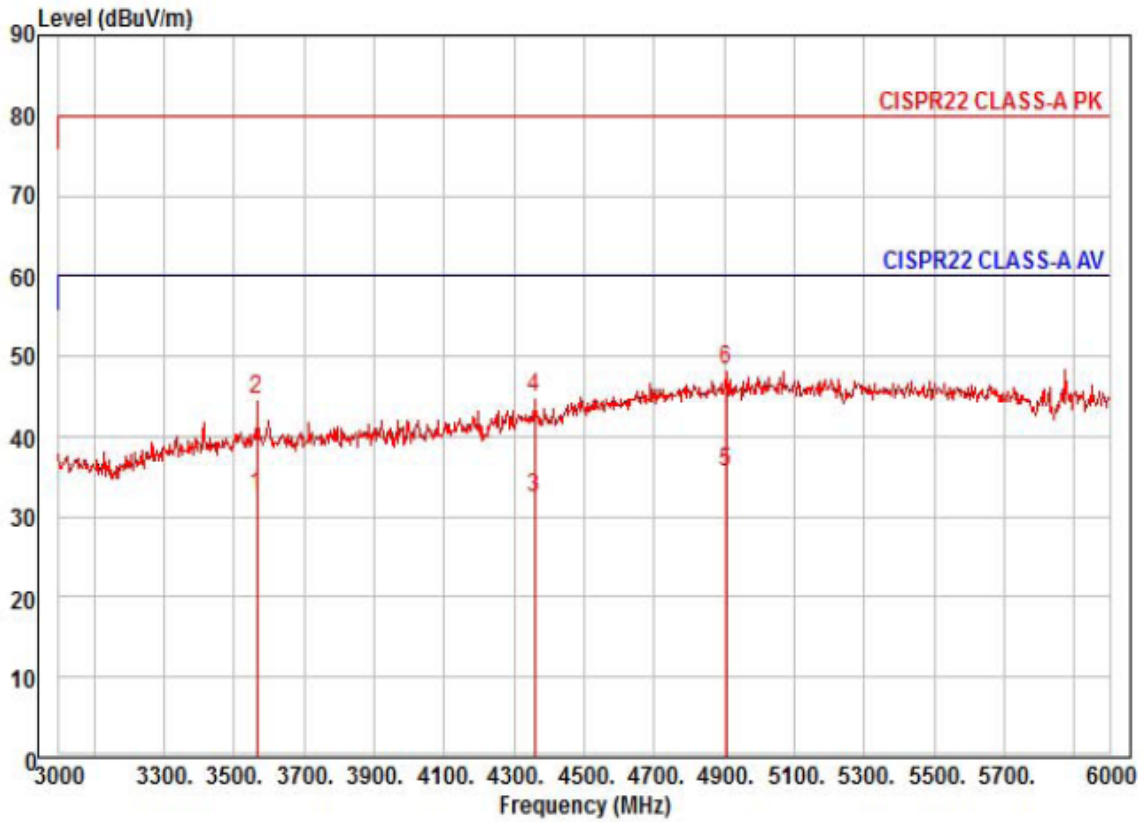

Site : chamber
 Condition: CISPR22 CLASS-A PK 3m HORN781(2015.05.07) vertical
 : RBW:1000.000kHz VBW:1000.000kHz SWT:Auto
 Project :
 Model : QNV-7030RP
 Mode : PoE
 Memo :

	Read Freq	Level	Ant Factor	Cable Loss	Preamp Factor	TPos	Limit Line	Over Limit	Pol/Phase	Remark
	MHz	dBuV	dB/m	dB	dB	deg	dBuV/m	dB		
1	3564.00	28.96	31.28	12.64	40.32	201	60.00	-27.44	vertical	Average
2	3564.00	40.93	31.28	12.64	40.32	201	80.00	-35.47	vertical	Peak
3	4359.00	24.56	34.06	14.17	40.41	184	60.00	-27.62	vertical	Average
4	4359.00	37.16	34.06	14.17	40.41	184	80.00	-35.02	vertical	Peak
5 pp	4905.00	23.74	37.18	15.16	40.41	251	60.00	-24.33	vertical	Average
6 pk	4905.00	36.32	37.18	15.16	40.41	251	80.00	-31.75	vertical	Peak

This report shall not be reproduced except in full, without the written approval of KES Co., Ltd.
 The results shown in this test report refer only to the sample(s) tested unless otherwise stated.



Harmonic Current Emissions and Voltage Fluctuations and Flicker

Average harmonic current results

Hn	I _{eff} [A]	% of Limit	Limit [A]	Result
1	N/A			
2				
3				
4				
5				
6				
7				
8				
9				
10				
11				
12				
13				
14				
15				
16				
17				
18				
19				
20				
21				
22				
23				
24				
25				
26				
27				
28				
29				
30				
31				
32				
33				
34				
35				
36				
37				
38				
39				
40				

This report shall not be reproduced except in full, without the written approval of KES Co., Ltd.
The results shown in this test report refer only to the sample(s) tested unless otherwise stated.



Test Data - Harmonics (continued)

Maximum harmonic current results

Hn	I _{eff} [A]	% of Limit	Limit [A]	Result
1	N/A			
2				
3				
4				
5				
6				
7				
8				
9				
10				
11				
12				
13				
14				
15				
16				
17				
18				
19				
20				
21				
22				
23				
24				
25				
26				
27				
28				
29				
30				
31				
32				
33				
34				
35				
36				
37				
38				
39				
40				

This report shall not be reproduced except in full, without the written approval of KES Co., Ltd.
The results shown in this test report refer only to the sample(s) tested unless otherwise stated.



Test Data - Voltage Fluctuations

Maximum Flicker results

	EUT values	Limit	Result
Pst	N/A		
Plt			
dc [%]			
dmax [%]			
Tmax [s]			

This report shall not be reproduced except in full, without the written approval of KES Co., Ltd.
The results shown in this test report refer only to the sample(s) tested unless otherwise stated.



KES Co., Ltd.

C-3701, Simin-daero 365-40,
Dongan-gu, Anyang-si, Gyeonggi-do, 14057, Korea
Tel: +82-31-425-6200 / Fax: +82-31-424-0450
www.kes.co.kr

Test report No.:
KES-E1-16T0211
Page (54) of (76)

Test Setup Photos and Configuration

Conducted Voltage Emissions

N/A

N/A

This report shall not be reproduced except in full, without the written approval of KES Co., Ltd.
The results shown in this test report refer only to the sample(s) tested unless otherwise stated.

Conducted Telecommunication Emissions

- DC 12V Mode

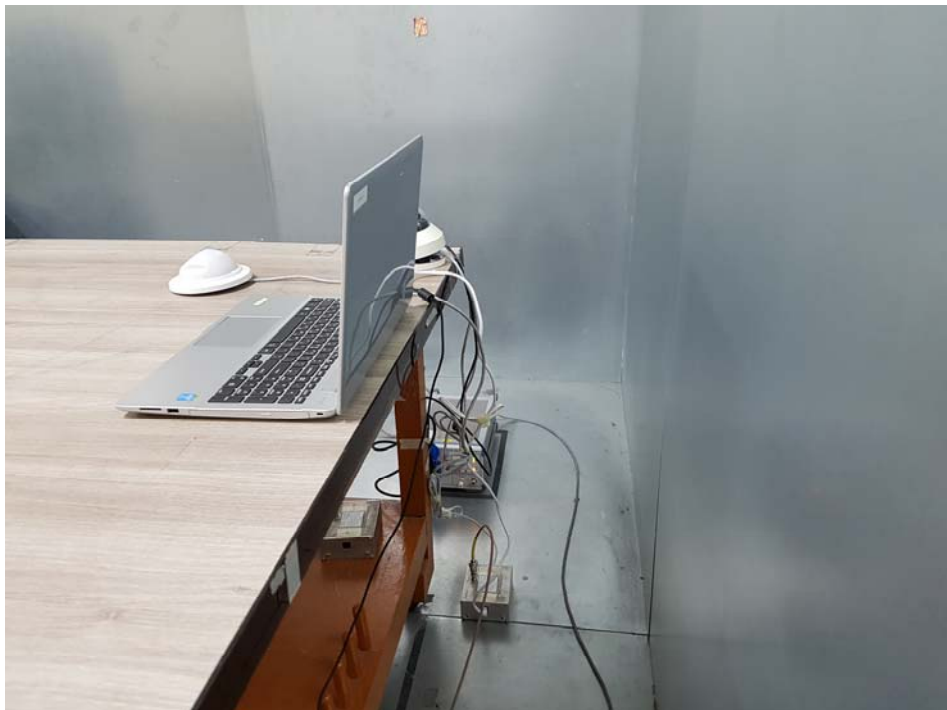

This report shall not be reproduced except in full, without the written approval of KES Co., Ltd.
The results shown in this test report refer only to the sample(s) tested unless otherwise stated.

- PoE Mode

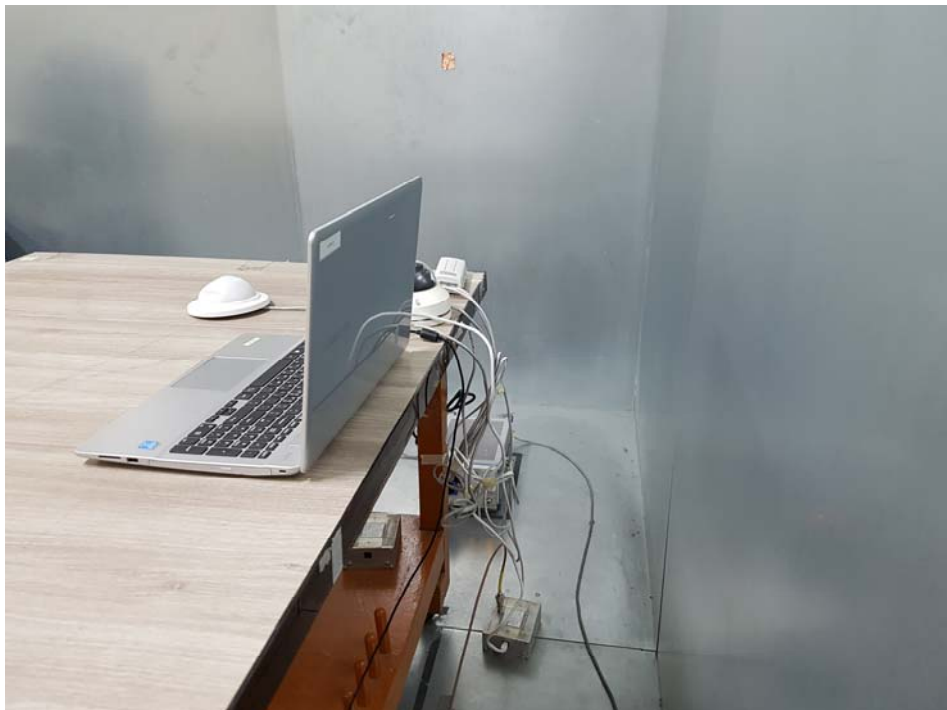

This report shall not be reproduced except in full, without the written approval of KES Co., Ltd.
The results shown in this test report refer only to the sample(s) tested unless otherwise stated.

Radiated Electric Field Emissions(Below 1 GHz)

- DC 12V Mode



This report shall not be reproduced except in full, without the written approval of KES Co., Ltd.
The results shown in this test report refer only to the sample(s) tested unless otherwise stated.

- PoE Mode



This report shall not be reproduced except in full, without the written approval of KES Co., Ltd.
The results shown in this test report refer only to the sample(s) tested unless otherwise stated.

Radiated Electric Field Emissions(Above 1 GHz)

- DC 12V Mode



This report shall not be reproduced except in full, without the written approval of KES Co., Ltd.
The results shown in this test report refer only to the sample(s) tested unless otherwise stated.

- PoE Mode

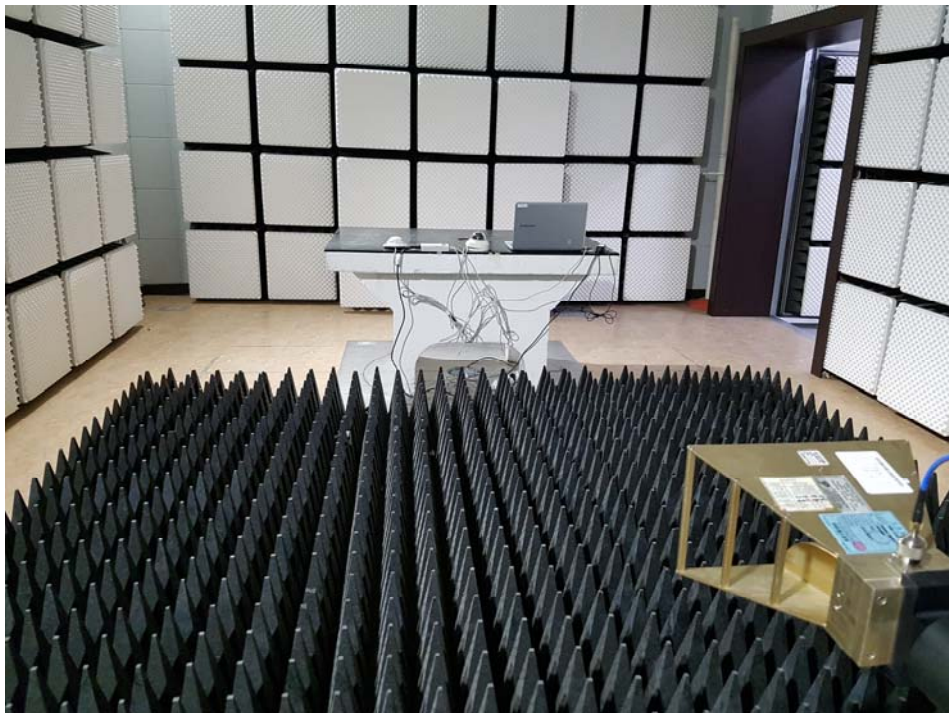

This report shall not be reproduced except in full, without the written approval of KES Co., Ltd.
The results shown in this test report refer only to the sample(s) tested unless otherwise stated.



KES Co., Ltd.

C-3701, Simin-daero 365-40,
Dongan-gu, Anyang-si, Gyeonggi-do, 14057, Korea
Tel: +82-31-425-6200 / Fax: +82-31-424-0450
www.kes.co.kr

Test report No.:
KES-E1-16T0211
Page (61) of (76)

Harmonic Current Emissions and Voltage Fluctuations and Flicker

N/A

This report shall not be reproduced except in full, without the written approval of KES Co., Ltd.
The results shown in this test report refer only to the sample(s) tested unless otherwise stated.

Electrostatic Discharge

- DC 12V Mode



- PoE Mode



This report shall not be reproduced except in full, without the written approval of KES Co., Ltd.
The results shown in this test report refer only to the sample(s) tested unless otherwise stated.

Radiated Electric Field Immunity

- DC 12V Mode

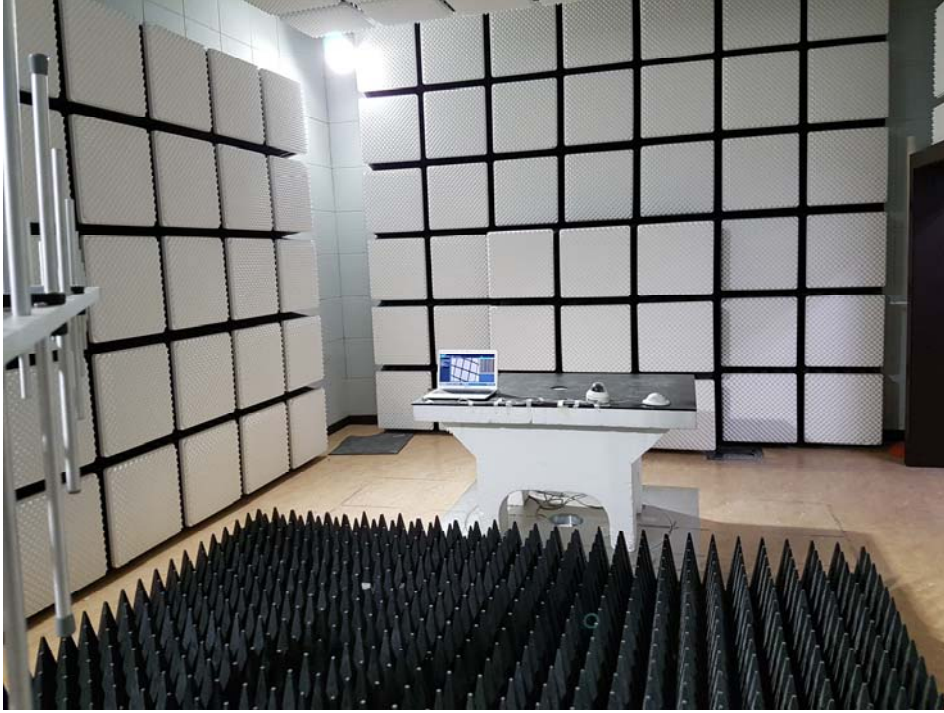

- PoE Mode

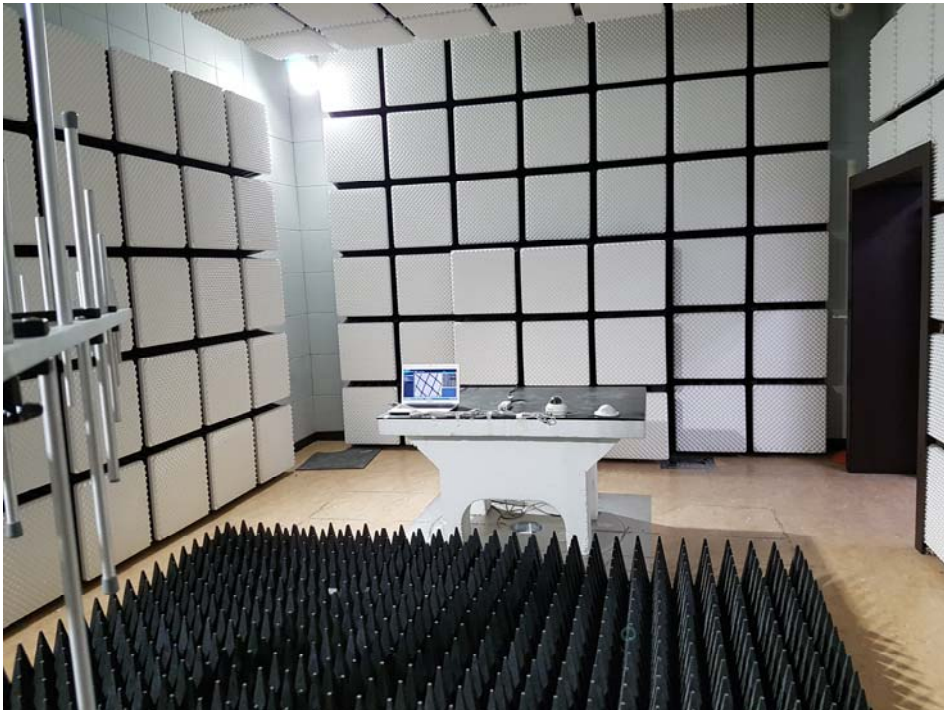

This report shall not be reproduced except in full, without the written approval of KES Co., Ltd.
The results shown in this test report refer only to the sample(s) tested unless otherwise stated.

Electrical Fast Transients/Bursts

- DC 12V Mode



This report shall not be reproduced except in full, without the written approval of KES Co., Ltd.
The results shown in this test report refer only to the sample(s) tested unless otherwise stated.

- PoE Mode



This report shall not be reproduced except in full, without the written approval of KES Co., Ltd.
The results shown in this test report refer only to the sample(s) tested unless otherwise stated.

Surge Transients

- DC 12V Mode



- PoE Mode



This report shall not be reproduced except in full, without the written approval of KES Co., Ltd.
The results shown in this test report refer only to the sample(s) tested unless otherwise stated.

Conducted Disturbance

- DC 12V Mode



This report shall not be reproduced except in full, without the written approval of KES Co., Ltd.
The results shown in this test report refer only to the sample(s) tested unless otherwise stated.

- PoE Mode



This report shall not be reproduced except in full, without the written approval of KES Co., Ltd.
The results shown in this test report refer only to the sample(s) tested unless otherwise stated.



KES Co., Ltd.

C-3701, Simin-daero 365-40,
Dongan-gu, Anyang-si, Gyeonggi-do, 14057, Korea
Tel: +82-31-425-6200 / Fax: +82-31-424-0450
www.kes.co.kr

Test report No.:
KES-E1-16T0211
Page (69) of (76)

Voltage Dips and Short Interruptions

N/A

This report shall not be reproduced except in full, without the written approval of KES Co., Ltd.
The results shown in this test report refer only to the sample(s) tested unless otherwise stated.

EUT External Photographs

(Top)



(Bottom)



This report shall not be reproduced except in full, without the written approval of KES Co., Ltd.
The results shown in this test report refer only to the sample(s) tested unless otherwise stated.

EUT Internal Photographs

(Internal View)



This report shall not be reproduced except in full, without the written approval of KES Co., Ltd.
The results shown in this test report refer only to the sample(s) tested unless otherwise stated.

Main Board EUT Internal View – Board1

(Top)



(Bottom)



This report shall not be reproduced except in full, without the written approval of KES Co., Ltd.
The results shown in this test report refer only to the sample(s) tested unless otherwise stated.

Main Board EUT Internal View – Board2

(Top)



(Bottom)



This report shall not be reproduced except in full, without the written approval of KES Co., Ltd.
The results shown in this test report refer only to the sample(s) tested unless otherwise stated.

Main Board EUT Internal View – Board3

(Top)



Main Board EUT Internal View – Camera

(Top)



(Bottom)

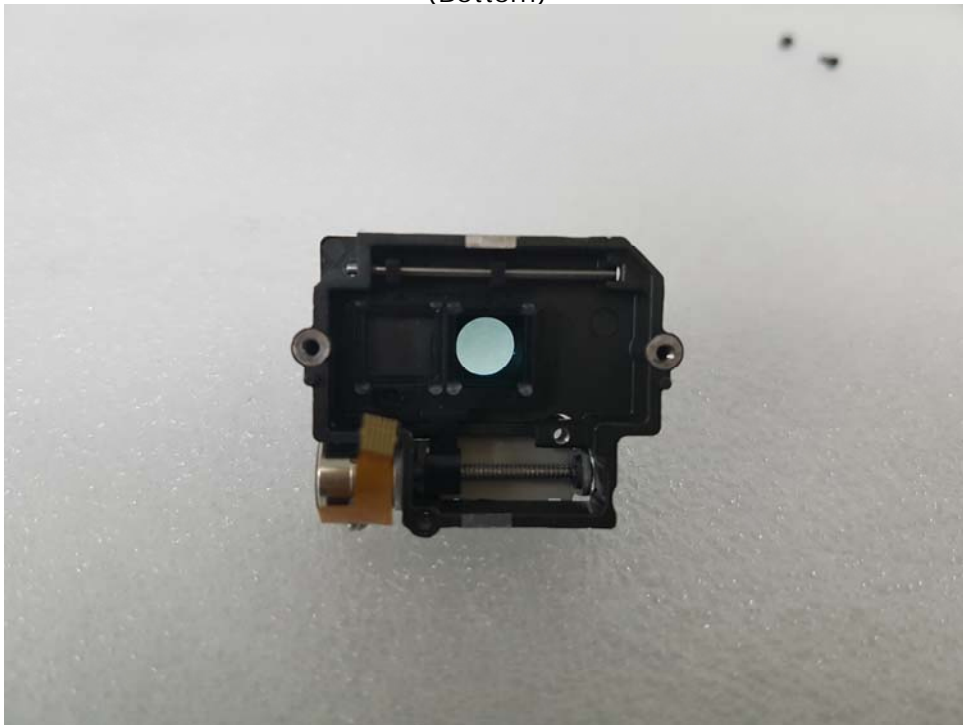

This report shall not be reproduced except in full, without the written approval of KES Co., Ltd.
The results shown in this test report refer only to the sample(s) tested unless otherwise stated.

Label and Location

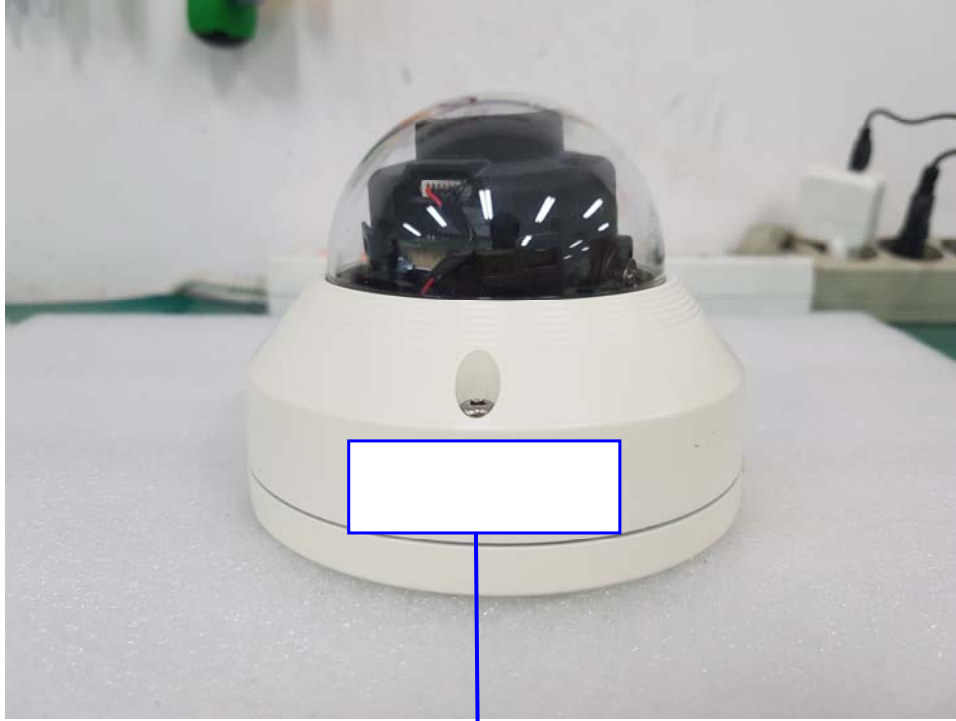

NETWORK CAMERA

Model No : QNV-7030RP

Manufacturer : Tianjin Samsung Techwin Opto-Electronic Co.,Ltd.

Made in of China