



English

PB-101 PG2 / PB-102 PG2

Wireless Panic Button



Installation Instructions

1. INTRODUCTION

The PB-101 PG2 and PB-102 PG2 are small PowerG pendants, designed for use with PowerMaster control panels and other PowerG receivers.

To activate transmission, press the pushbutton(s) at the center of the unit. When activated, the transmitter sends an alarm code, a LED indication that confirms successful or failed transmission, and (*only in PB-102*) a buzzer sounds.

The PB-101/102 has several options for carrying or mounting it. The unit is supplied with a belt clip, a key chain, a lanyard necklace, and a holder which can be attached to the belt clip or mounted on a wall.

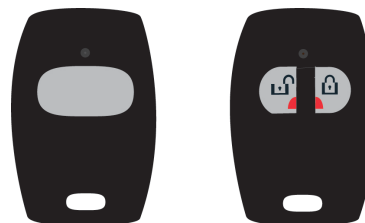

Figure 1. PB-101 and PB-102

2. OPERATION

⚠ Caution! This equipment must be used in non-hazardous locations only. This equipment is designed and listed for use in security / alarm systems and applications. It is not designed or listed for use in health care signaling or life safety applications.

The following functions are available:

Function	PB-101		PB-102	
Panic The signal notifies your panel of an emergency situation.		Press and hold the button down for 3 – 5 seconds, the red LED lights. The green LED lights to confirm a successful transmission.		Press and hold both buttons down simultaneously for more than 3 seconds.
Arm Arm your system in the Away mode.	---	Not applicable		Press and hold this button for at least 1 second.
Disarm Disarm your system.	---	Not applicable		Press and hold this button for at least 1 second.

3. ASSEMBLY FOR PORTABILITY AND MOUNTING

This section describes how to attach the PB-101/102 to various portability options.

⚠ Warning! Choking Hazard; Small parts; The pendant and belt clip are NOT for children under 3 years.

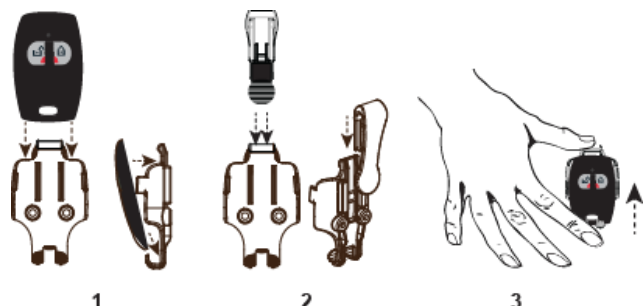

Figure 2 Attaching PB-101/102 to a Belt Clip

- Slide the PB-101/102 into the holder until you feel it snap securely inside.
- To attach the belt clip, slide it onto the rails on the rear of the holder.

- To remove the PB-101/102 from the wall-mounted holder or from the belt clip, press down the top of the holder and push the pendant up with your fingers.



Figure 3 Attaching PB-101/102 to a Key Chain



Figure 4 Attaching PB-101/102 to a Lanyard Necklace

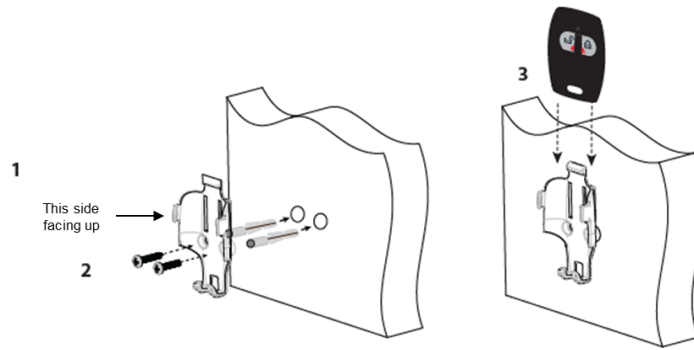



Figure 5 Attaching PB-101/102 to a Wall Mount

1. Using the two screws and plastic anchors included in the PB-101/102 box, align the holder facing up and secure the holder to the wall.
2. Slide the PB-101/102 into the holder until you feel it snap securely inside.
3. To remove the PB 101/102 from the holder, press down the top of the holder and push the pendant up with your fingers as illustrated in Figure 2.

4. ENROLLMENT AND CONFIGURATION OF PB-101/102

4.1. Enrollment

The Enrollment process "teaches" the system's control panel the ID of the PB-101/102 and enables the PB-101/102 to communicate with the panel.

1. Enter the PowerMaster panel's Installer menu and select "02:ZONES/DEVICES".
2. Select "ADD NEW DEVICE" Option.
3. Stand near the PowerMaster panel. Press and hold the  button (for PB-101 PG2) or the left  button (for PB-102 PG2) until the yellow LED turns on, and then release the button. Ensure that the LED stays on for 2 seconds and then flashes for 10 seconds.

4.2. Configuring the Panic Button Parameters (for PowerG Version 18 systems only)

Enter the **DEVICE SETTINGS** menu and follow the configuration instructions for the PB-101 PG2 and PB-102 PG2 panic buttons as described below.

Option	Configuration Instructions
Functionality¹	Define whether to use to Arm/Disarm or to operate the PGM.
	Optional settings: Arm/Disarm (default) and PGM ON/OFF.
Supervision	Define whether the control panel will monitor supervision messages sent by the panic button for a time period of 8 hours.
	Optional settings: Disabled (default) and Enabled.

5. TESTING AND MAINTENANCE

5.1. Testing a New Unit

Since the PB-101/102 is supplied with the battery already installed, the unit is practically ready to be tested.

Important! Before testing, enroll the PB-101/102 in the target control panel as instructed in the panel's programming instructions.

1. Stand 3 m (10 ft) away from the control panel and press the buttons. Verify that the transmit LED lights.
2. Make sure that the control panel responds as programmed and as stated in the panel's programming instructions.

3. Operate the pendant from various locations within the area covered by the receiver to determine "dead" locations, where transmission is blocked by walls and large objects, or affected by structural materials.

Note: If dead/marginal zones are a problem, relocating the receiver may improve the performance.

¹Applies to PB-102 PG2 only

5.2. Replacing the Battery

Replace the battery at least once every 5 years, or upon observing that the LED flickers when transmitting. The required battery is CR2032 Lithium 3V, manufactured by VARTA or another UL-recognized manufacturer, purchased from a Visonic-approved supplier.

Note: The polarity of the battery must be observed, as shown in Figure 7. Improper handling of lithium batteries may result in heat generation, explosion or fire, which may lead to personal injuries.
Warning! Danger of explosion if batteries are installed incorrectly. Replace only with the same or equivalent type recommended by the manufacturer. Keep away from small children. If batteries are swallowed, promptly see a doctor. Do not try to recharge these batteries. Disposal of used batteries must be made in accordance with the waste recovery and recycling regulations in your area.

1. Insert a coin into the slot on the bottom center of the device and twist to separate the two sides.
2. Then, slide the coin to the corner of the device and twist again to remove the cover.

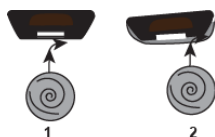

Figure 6. Opening the PB-101/102

Note: Make sure the elastic pad within the cover remains in place. Put it back in place if it falls off.

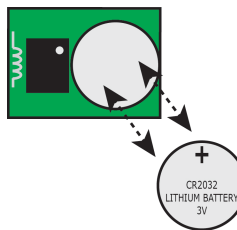

Figure 7. Replacing the Battery

3. Extract the old battery from its holder, and replace it with a recommended new battery. Ensure that the plus side of the battery faces up, attaining correct polarity.
4. Test the unit by momentarily pressing one of the transmit switches. The LED indicator should light.
5. Put the covers back on securely, verifying that it snaps shut.

5.3. Cleaning

The pendant may get dirty if touched with greasy fingers. Clean it only with a soft cloth or sponge moistened lightly with a mixture of water and mild detergent, and wipe it dry immediately.

The use of abrasives of any kind is strictly forbidden. Also never use solvents such as kerosene, acetone or thinner. Do not submerge this product in any liquid, in order to prevent damage to the electronic circuits.

6. PRODUCT LIMITATIONS

Visonic wireless systems are very reliable and are tested to high standards. However, due to their low transmitting power and limited range (required by FCC and other regulatory authorities), there are some limitations to be considered:

- A. Receivers may be blocked by radio signals occurring on or near their operating frequencies, regardless of the code selected.
- B. A receiver can only respond to one transmitted signal at a time.
- C. Wireless equipment should be tested regularly to determine whether there are sources of interference and to protect against faults.

Frequency Allocations for Wireless Devices in European (EU) Countries

433.92 MHz has no restriction in any EU member state.

7. COMPLIANCE WITH STANDARDS



The PB-101/102 PG2 complies with the following standards:

Europe: EN 300220, EN 301489 EN 50130-4, EN 50130-5, EN 60950-1, EN-50131-3 and EN-50131-6 Type C.

Hereby, Visonic Ltd. declares that the radio equipment type PB101/102 PG2 is in compliance with Directive 2014/53/EU.

The full text of the EU declaration of conformity is available at the following internet address:

<http://www.visonic.com/download-center>.

EN 50131-1 Security Grade: According to EN 50131-1 this equipment can be applied in installed systems up to and including Security Grade 2.

EN 50131-1 Environmental Class: Class II

Certified by Aplica Test & Certification AS in accordance with EN 50131-3, EN 50131-6, EN 50131-4, EN 50131-5.

UK: This product is suitable for use in systems installed to conform to PD6662:2010 at Grade 2 and environmental class 2. DD243 and BS8243.
USA: FCC-CFR 47 part 15
Canada: IC-RSS 210

The Power G peripheral devices have two- way communication functionality, providing additional benefits as described in the technical brochure. This functionality has not been tested to comply with the respective technical requirements and should therefore be considered outside the scope of the product's certification.

FCC Compliance Statement

The digital circuitry of this device has been tested and found to comply with the limits for a Class B digital device, pursuant to Part 15 of the FCC Rules. These limits are designed to provide reasonable protection against harmful interference in residential installations. This equipment generates, uses, and can radiate radio frequency energy and, if not installed and used in accordance with the instructions, may cause harmful interference to radio and television reception. However, there is no guarantee that interference will not occur in a particular installation. If this device does cause such interference, which can be verified by turning the device off and on, the user is encouraged to eliminate the interference by one or more of the following measures:

- Re-orient or re-locate the receiving antenna.
- Increase the distance between the device and the receiver.
- Connect the device to an outlet on a circuit different from the one which supplies power to the receiver.
- Consult the dealer or an experienced radio/TV technician

This equipment complies with FCC and IC RF radiation exposure limits set forth for an uncontrolled environment.

Changes or modifications to this unit not expressly approved by the party responsible for compliance could void the user's authority to operate the equipment.

This device complies with FCC Rules Part 15 and with Industry Canada licence-exempt RSS standard(s). Operation is subject to two conditions: (1) This device may not cause harmful interference, and (2) this device must accept any interference that may be received or that may cause undesired operation.

Le present appareil est conforme aux CNR d'Industrie Canada applicables aux appareils radio exempts de licence. L'exploitation est autorisee aux deux conditions suivantes : (1) l'appareil ne doit pas produire de brouillage, et (2) l'utilisateur de l'appareil doit accepter tout brouillage radioelectrique subi, meme si le brouillage est susceptible d'en compromettre le fonctionnement.

APPENDIX: SPECIFICATIONS

Frequency Band (MHz)	Europe and rest of world: 433-434.72, 868-869.15 USA: 912-919.185
Maximum Tx Power	10 dBm @ 433 MHz, @ 868MHz
Battery type	Varta 3V CR-2032 Lithium battery.
Low Battery Threshold	2.05 V
Battery Life Expectancy	up to 5 years
Operating Temperature	-10° to 55°C (14° to 131°F)
Humidity	Average relative humidity (RH) ~ 75% non-condensing, max 95% 30 days/year
Dimensions (LxWxD)	53 x 33 x 11 mm (2.1 x 1.3 x 0.43 in)
Weight	15 gm (0.5 oz)
Weight (including battery)	20 gm (0.7 oz)

 **W.E.E.E. Product Recycling Declaration**
 For information regarding the recycling of this product you must contact the company from which you originally purchased it. If you are discarding this product and not returning it for repair then you must ensure that it is returned as identified by your supplier. This product is not to be thrown away with everyday waste.
 Directive 2002/96/EC Waste Electrical and Electronic Equipment.

WARRANTY

Visonic Limited (the "Manufacturer") warrants this product only (the "Product") to the original purchaser only (the "Purchaser") against defective workmanship and materials under normal use of the Product for a period of twelve (12) months from the date of shipment by the Manufacturer.

This Warranty is absolutely conditional upon the Product having been properly installed, maintained and operated under conditions of normal use in accordance with the Manufacturers recommended installation and operation instructions. Products which have become defective for any other reason, according to the Manufacturers discretion, such as improper installation, failure to follow recommended installation and operational instructions, neglect, willful damage, misuse or vandalism, accidental damage, alteration or tampering, or repair by anyone other than the manufacturer, are not covered by this Warranty.

There is absolutely no warranty on software, and all software products are sold as a user license under the terms of the software license agreement included with such Product."

The Manufacturer does not represent that this Product may not be compromised and/or circumvented or that the Product will prevent any death and/or personal injury and/or damage to property resulting from burglary, robbery, fire or otherwise, or that the Product will in all cases provide adequate warning or protection. The Product, properly installed and maintained, only reduces the risk of such events without warning and it is not a guarantee or insurance that such events will not occur.

Conditions to Void Warranty: This warranty applies only to defects in parts and workmanship relating to normal use of the Products. It does not cover:

- * damage incurred in shipping or handling;
- * damage caused by disaster such as fire, flood, wind, earthquake or lightning;
- * damage due to causes beyond the control of the Seller such as excessive voltage, mechanical shock or water damage;
- * damage caused by unauthorized attachment, alterations, modifications or foreign objects being used with or in conjunction with the Products;
- * damage caused by peripherals (unless such peripherals were supplied by the Seller;
- * defects caused by failure to provide a suitable installation environment for the products;
- * damage caused by use of the Products for purposes other than those for which they were designed;
- * damage from improper maintenance;
- * damage arising out of any other abuse, mishandling or improper application of the Products.

Items Not Covered by Warranty: In addition to the items which void the Warranty, the following items shall not be covered by Warranty: (i) freight cost to the repair centre; (ii) customs fees, taxes, or VAT that may be due; (iii) Products which are not identified with the Seller's product label and lot number or serial number; (iv) Products disassembled or repaired in such a manner as to adversely affect performance or prevent adequate inspection or testing to verify any warranty claim. Access cards or tags returned for replacement under warranty will be credited or replaced at the Seller's option.

THIS WARRANTY IS EXCLUSIVE AND EXPRESSLY IN LIEU OF ALL OTHER WARRANTIES, OBLIGATIONS OR LIABILITIES, WHETHER WRITTEN, ORAL, EXPRESS OR IMPLIED, INCLUDING ANY WARRANTY OF MERCHANTABILITY OR FITNESS FOR A PARTICULAR PURPOSE, OR OTHERWISE. IN NO CASE SHALL THE MANUFACTURER BE LIABLE TO ANYONE FOR ANY CONSEQUENTIAL OR INCIDENTAL DAMAGES FOR BREACH OF THIS WARRANTY OR ANY OTHER WARRANTIES WHATSOEVER, AS AFORESAID.

THE MANUFACTURER SHALL IN NO EVENT BE LIABLE FOR ANY SPECIAL, INDIRECT, INCIDENTAL, CONSEQUENTIAL OR PUNITIVE DAMAGES OR FOR LOSS, DAMAGE, OR EXPENSE, INCLUDING LOSS OF USE, PROFITS, REVENUE, OR GOODWILL, DIRECTLY OR INDIRECTLY ARISING FROM PURCHASER'S USE OR INABILITY TO USE THE PRODUCT, OR FOR LOSS OR DESTRUCTION OF OTHER PROPERTY OR FROM ANY OTHER CAUSE, EVEN IF MANUFACTURER HAS BEEN ADVISED OF THE POSSIBILITY OF SUCH DAMAGE.

THE MANUFACTURER SHALL HAVE NO LIABILITY FOR ANY DEATH, PERSONAL AND/OR BODILY INJURY AND/OR DAMAGE TO PROPERTY OR OTHER LOSS WHETHER DIRECT, INDIRECT, INCIDENTAL, CONSEQUENTIAL OR OTHERWISE, BASED ON A CLAIM THAT THE PRODUCT FAILED TO FUNCTION. HOWEVER, IF THE MANUFACTURER IS HELD LIABLE, WHETHER DIRECTLY OR INDIRECTLY, FOR ANY LOSS OR DAMAGE ARISING UNDER THIS LIMITED WARRANTY, THE MANUFACTURER'S MAXIMUM LIABILITY (IF ANY) SHALL NOT IN ANY CASE EXCEED THE PURCHASE PRICE OF THE PRODUCT INVOLVED, WHICH SHALL BE FIXED AS LIQUIDATED DAMAGES AND NOT AS A PENALTY, AND SHALL BE THE COMPLETE AND EXCLUSIVE REMEDY AGAINST THE MANUFACTURER. SOME JURISDICTIONS DO NOT ALLOW THE EXCLUSION OR LIMITATION OF INCIDENTAL OR CONSEQUENTIAL DAMAGES, SO THESE LIMITATIONS MAY NOT APPLY UNDER CERTAIN CIRCUMSTANCES.

When accepting the delivery of the Product, the Purchaser agrees to the said conditions of sale and warranty and he recognizes having been informed of.

The Manufacturer shall be under no liability whatsoever arising out of the corruption and/or malfunctioning of any telecommunication or electronic equipment or any programs.

The Manufacturer's obligations under this Warranty are limited solely to repair and/or replace at the Manufacturer's discretion any Product or part thereof that may prove defective. Any repair and/or replacement shall not extend the original Warranty period. The Manufacturer shall not be responsible for dismantling and/or reinstallation costs. To exercise this Warranty the Product must be returned to the Manufacturer freight pre-paid and insured. All freight and insurance costs are the responsibility of the Purchaser and are not included in this Warranty.

For sales in Israel only:

The Purchaser shall comply with the provisions of the Israeli Consumer Protection Law – 1981 ("Consumer Protection Law") related regulations, including the Israeli Consumer Protection Regulations (Warranty Sticker), 5772-2012 ("Regulations"), including, without limitation (i) providing its customers with at least the minimum warranty required by the Consumer Protection Law, and (ii) ensuring that a warranty certificate and a warranty sticker (as defined in the Regulations) ("Warranty Sticker") shall be attached to any sold Products and the date of the sale of the Product to the consumer or the end-user shall be added in a readable manner on the Warranty Sticker.

In no event shall the Purchaser's compliance with the Consumer Protection Law and Regulations expand any of the Manufacturer's warranty obligations under this warranty, and the Purchaser shall be responsible for any warranty that it provides with respect to the Products which exceeds or is different from this warranty.

This warranty shall not be modified, varied or extended, and the Manufacturer does not authorize any person to act on its behalf in the modification, variation or extension of this warranty. This warranty shall apply to the Product only. All products, accessories or attachments of others used in conjunction with the Product, including batteries, shall be covered solely by their own warranty, if any. The Manufacturer shall not be liable for any damage or loss whatsoever, whether directly, indirectly, incidentally, consequentially or otherwise, caused by the malfunction of the Product due to products, accessories, or attachments of others, including batteries, used in conjunction with the Products. This Warranty is exclusive to the original Purchaser and is not assignable.

This Warranty is in addition to and does not affect your legal rights. Any provision in this warranty which is contrary to the Law in the state or country where the Product is supplied shall not apply.

Governing Law: This disclaimer of warranties and limited warranty are governed by the domestic laws of Israel.

Warning

The user must follow the Manufacturer's installation and operational instructions including testing the Product and its whole system at least once a week and to take all necessary precautions for his/her safety and the protection of his/her property.

* In case of a conflict, contradiction or interpretation between the English version of the warranty and other versions, the English version shall prevail.



Email: info@visonic.com

Internet: www.visonic.com

© VISONIC LTD. 2018 PB-101 PG2 / PB-102 PG2 D-304457 (Rev. 6 05/18)

