

DUOX
SMART SYSTEM

DUOX SYSTEM GUIDE

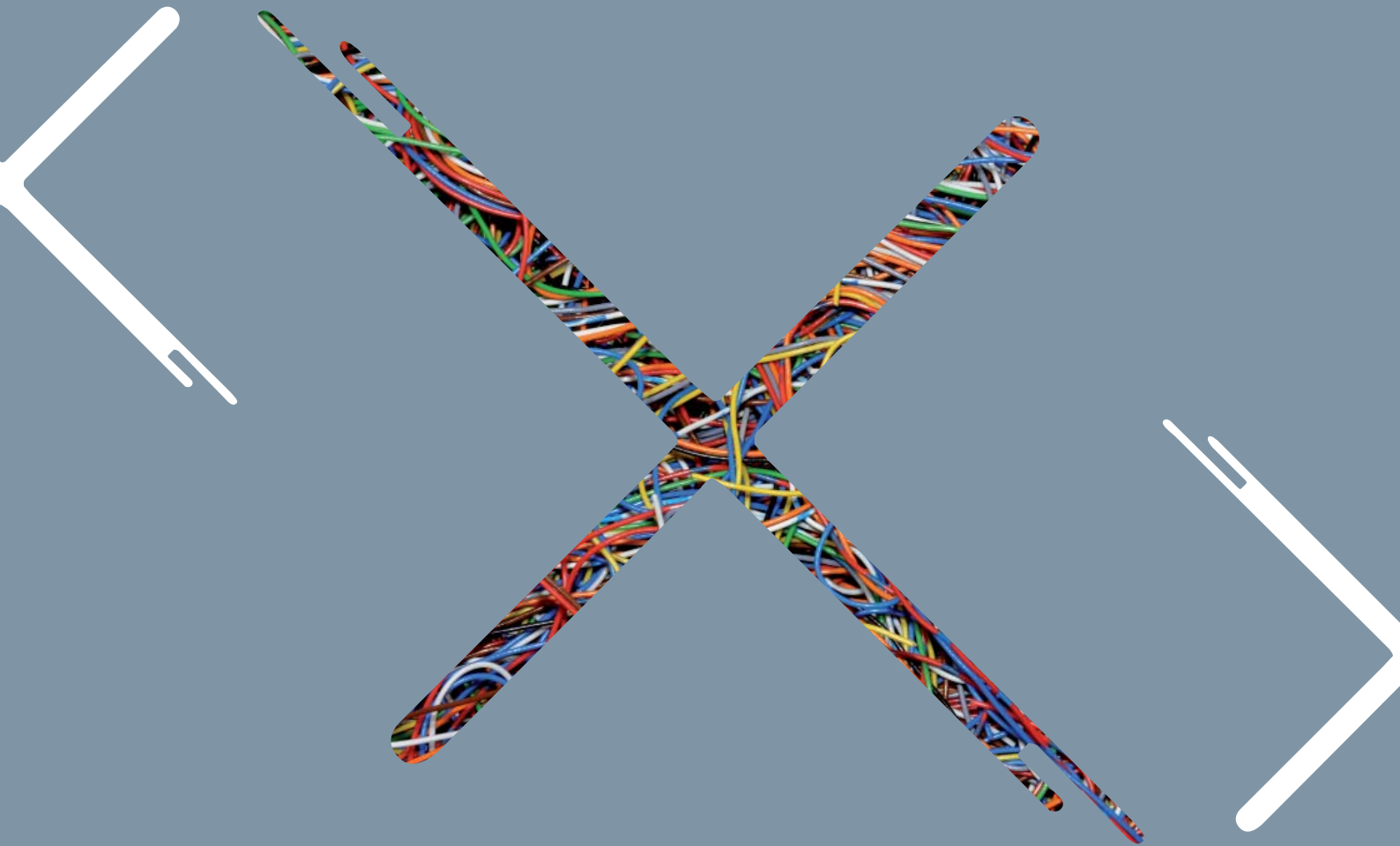







FERMAX

This document shows the basic concepts for a quick start-up. For more information download the manuals at www.fermax.com

*Technical publication of an informative nature published by FERMAX ELECTRONICA S.A.U.
As part of its constant improvement policy, FERMAX reserves the right to modify the content of this document and the characteristics of the products referred to in it at any time and without prior notice. Any modification will be reflected in subsequent editions of this document.*

970029I V11_16

TABLE OF CONTENTS

	INTRODUCTION	5
<hr/>		
	KEY SYSTEM ELEMENTS DUOX	8
	Street panel	9
	Residence terminals	9
	Power set	10
	Line adapter	10
<hr/>		
	INSTALLATION BÁSICA DUOX	13
	Duox Wiring Considerations	14
	BASIC DUOX INSTALLATION	14
	Diagrams y tables de installations DUOX	15
<hr/>		
	INSTALACIÓN ADVANCED DUOX	19
	REGENERATORS DUOX	20
	Duox Relay	27
<hr/>		
	DUOX INSTALLATION DESIGN	28
	Design procedure	29
	Design of the Duox Basic installation Example	31
	Design of the Advanced installation Examples	35
<hr/>		
	FREQUENTLY ASKED QUESTIONS	41
<hr/>		
	APPENDIX. TECHNICAL EXTENSION	42
<hr/>		

DUOX by FERMAX

SIMPLICITY



FLEXIBILITY



CAPACITY



DIGITAL TRANSMISSION



INTUITIVE PROGRAMMING



THE USER DECIDES



This document is a Guide to design the most common video entry system installations with a DUOX system. Ask your Sales representative or our Technical department about other installations that do not fit those shown in this document.

INTRODUCTION

DUOX is the first completely digital video entry communication system via 2 non-polarized wires.

These characteristics make it a very **versatile and scalable system**, recommended for installations in both new construction and as replacements. In this latter case, it has a wide scope of applications due to its **flexibility**, since it can be installed on a wide range of wiring.

Its flexibility also extends to the user's decision-making power, like if they initially decide to install a telephone in their home, they can change it to a monitor whenever they please.

With Duox you can:

- Up to 10 general entry panels.
- Each general entrance can have up to 10 more secondary panels.
- Up to 999,999 apartment addresses.

All of this with a limited number of intermediaries.

INSTALLATION SIMPLICITY

Duox saves you installation time thanks to its:

A) Reduced number of necessary elements in the installation:

- Without distributors
- Without switchers
- Without decoders

B) Intuitive programming:

DUOX is very simple to program, without needing to use any additional element to start it up:

- DUOX monitors are programmed in just seconds, directly from the OSD menu on the terminal, making it possible for a single person to program the installation.
- Push-button panels include an exclusive voice synthesizer system that guides the installer during programming.

DUOX INSTALLATION



BASIC INSTALLATION

When talking about a Basic DUOX Installation, we are referring to every installation that can be installed without regenerators. Usually these have 40/100 terminals distributed in a maximum of 4 risers, even though the characteristics and number of devices of the Basic Duox Installation can vary depending on the installation topology. In the diagrams on pages 15 through 18 we include some of the most common Basic Installations.

In a Basic Installation only the following devices are present:

- Street panel
- Power set
- Monitors and telephones
- Line adapters

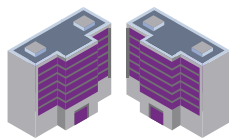
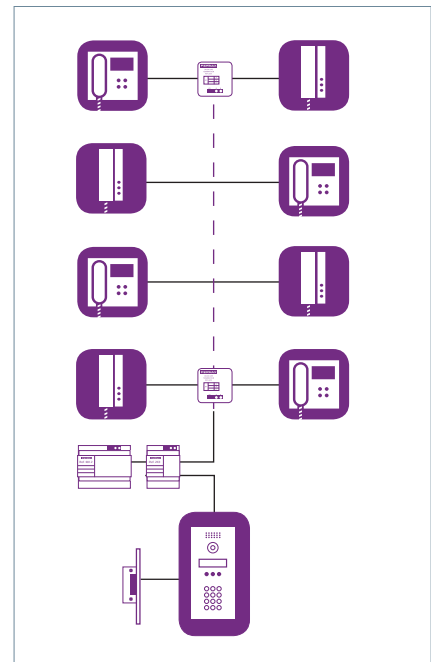

ADVANCED INSTALLATION

An advanced Installation is any installation that surpasses the characteristics indicated in the diagrams on pages 15 to 18. In order to carry out these installations, you must use regenerators.

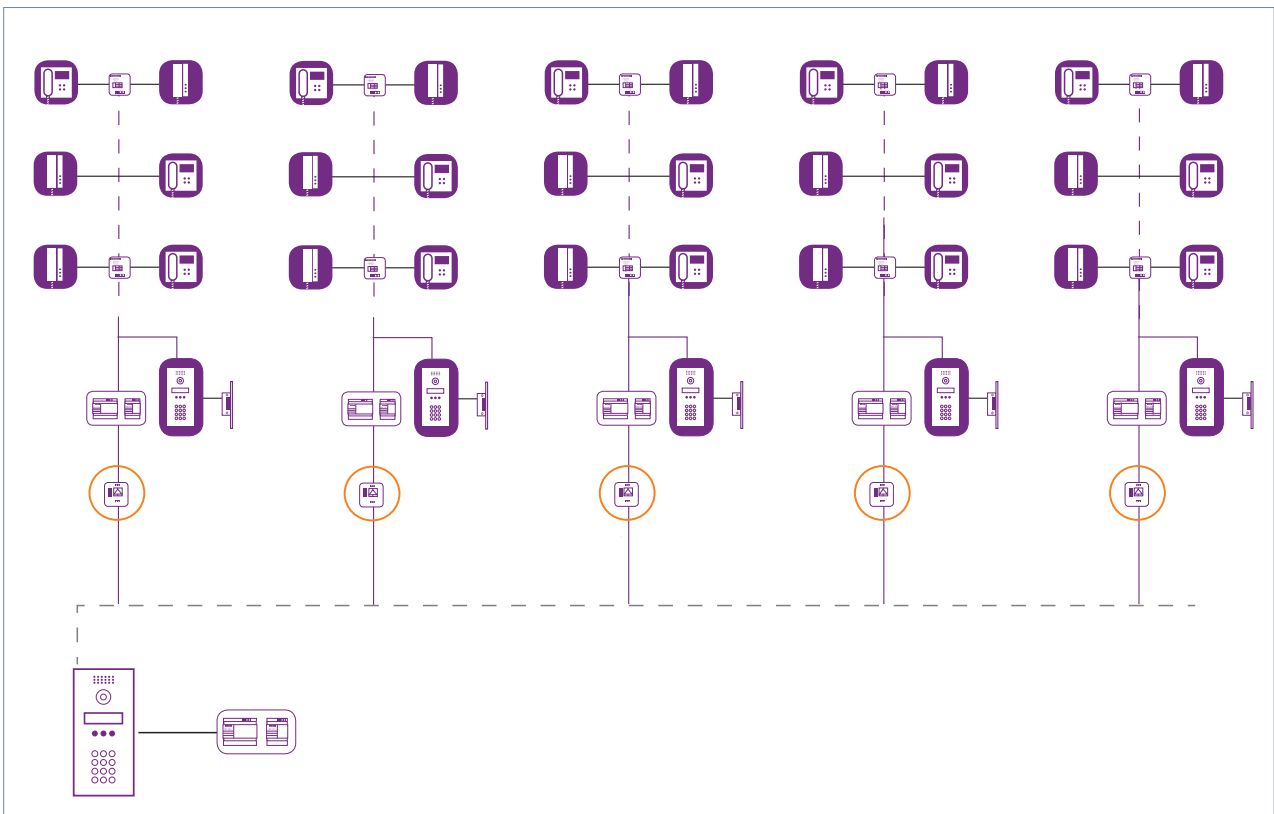

DUOX SYSTEM CONSIDERATIONS

To install DUOX, you need to keep in mind:

1. Know the distance between the street panel and power set.
2. Know the wiring the installation will be using.
DUOX allows you ample flexibility in terms of cable types (as long as they are in good condition), even with those existing in older installations (UTP CAT-5, 4+N, 5 wires, or even 2 wire) always respecting the specifications in the DUOX characteristics. The following is recommended use parallel cable de 1 mm² (Ref. 5952 de Fermax). The following is recommended no use cable unipolar.
3. The system DUOX no requiere floor level distributors, con una connections grid realizamos las distribuciones.
4. Line adaptors are required to balance the impedances, at the beginning and end of the transmission line.

KEY SYSTEM ELEMENTS

The main elements of the DUOX system are those that are present in all installations, independently of their size.

STREET PANEL

Standard with colour camera



TERMINALS

Monitors



POWER SET

Power source



Filter



As of now will refer to the power source group (Ref. 4810/ 4812/ 4830) + filter (Ref. 3244) as **POWER SET**.

Telephones



LINE ADAPTER

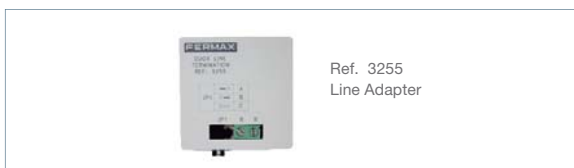

STREET PANEL

The DUOX street panels includes the video amplifier with a wide angle camera, high sensitivity, that includes a focus regulation system on the camera.

They are all available with the FERMAX aesthetics, both with push buttons and digital.

The digital panel scan incorporate the 3.5" DIGITAL EXTRA DISPLAY, high luminosity for exteriors, that facilitates its use and the panel's possibilities.

The DUOX amplifier incorporates a voice-guided programming system that facilitates the push button panels, configuration and installations start-up. This display

The DUOX panel's amplifier includes the default voice synthesizer. A message is emitted when the door-opener is activated: "Door Open. Door open, please close after entering".



RESIDENTIAL TERMINALS

FERMAX offers a wide range of terminals for your home with DUOX technology:

- Monitors: VEO, LOFT and iLOFT
- Telephones: LOFT and Citymax

In a DUOX installation, you can combine DUOX monitors and telephones without needing to add additional elements.

The maximum num. of terminals per home is three. In order to extend the num. of terminals in a home, you may need to add a power set, relative to the existing number of monitors and homes, its topology, cable type, etc.

DUOX monitors are programmed in just seconds, directly from the OSD menu on the terminal, making it possible for a single person to program the installation.



KEY SYSTEM ELEMENTS

POWER SET: POWER SOURCE AND DUOX FILTER

The DUOX system is powered with an 18Vdc voltage. You can use any of the following power sources⁽¹⁾:

Ref. 4810. Power source 18Vdc/1.5A-12Vac/1.5A

Ref. 4812. 18Vdc/1.5A Power Source

Ref. 4830. 18Vdc/3.5A Power Source

The power sources must always come with a DUOX filter Ref. 3244. The set of source+filter is called "Power Set."

The source Ref. 4830 supports a maximum of 40 terminals and sources Ref. 4810/4812 support a maximum of 24 terminals.

The distance between the power set to the last terminal to power depends on the installation's cable type and topology. The following table shows the maximum distances for common installations.

TABLE 1. MAXIMUM DISTANCE POWER SET/FURTHEST FLOOR (m)

TYPE OF CABLE	Cascade	2 terminals per floor ⁽²⁾	4/6 terminals per floor ⁽²⁾
2x1mm ²	80m	55m	35m
2x0.5mm ²	50m	35m	25m
2x0.22mm ²	30m	20m	16m

⁽²⁾ 20m maximum distance between the floor's register and the furthest terminal (additional to the indicated distance).

1 terminal per home (any extension in the home must include a power set).

DUOX LINE ADAPTER

The DUOX system always employs line adapters (Ref. 3255) to balance impedances in the transmission line.

Line adapters must be installed. Its location and configuration depends on the installation topology (num. of shunts, additional elements...)

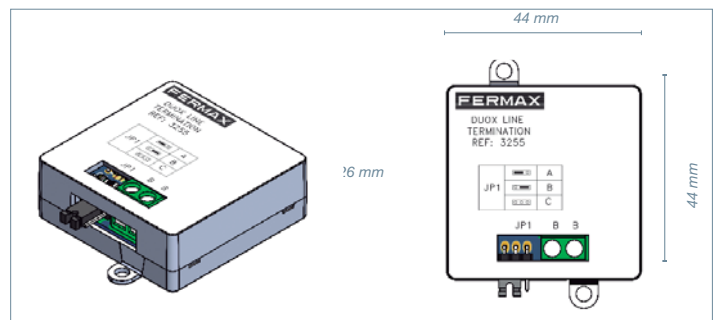

⁽¹⁾ See compatible versions in the "Technical extension Annex"

INSTALL AN ADAPTER

Each installation section requires line adapters. Below we describe how to install and configure the line adapters properly in just three steps:

1. Where should we install the adapter?
2. In what mode?: “C”, “A”
3. There are different devices that include a line adapter in its structure. What devices can we use as a line adapter?

STEP 1 WHERE TO INSTALL AN ADAPTER?

In general, we can say that you can always install adapters at the beginning and end of the shunt, but the adapter location depends slightly on the number of shunts and if the installation is in cascade or has several terminals per derivation point.

A) In cascade installations:

- One shunt: place a line adapter in the first terminal and another on the last terminal (*Image 2.3*).
- More than one shunt: Place a line adapter at the bifurcation and another one at the last terminal of each shunt.

B) En instalaciones con miscellaneous terminals por derivation point:

- One shunt: place the line adapter in the floor's first derivation and another line adapter at the floor's last derivation point (*image 2.1*).
- Más de una shunt: situar un line adaptor en la primera bifurcation y other line adaptor: la derivation más alejada de la entry panel keypad, de cada shunt.

C) There is one particular case, when a bus does not have terminals (for example when there are 2 regenerators and the bus joining them doesn't have telephones or monitors connected, as shown in Image 6, page 22); in this case connect an adapter to the beginning of the bus and another at the end. (*Image 2.2*).

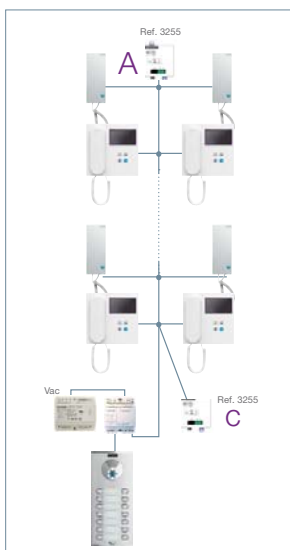

Image 2.1

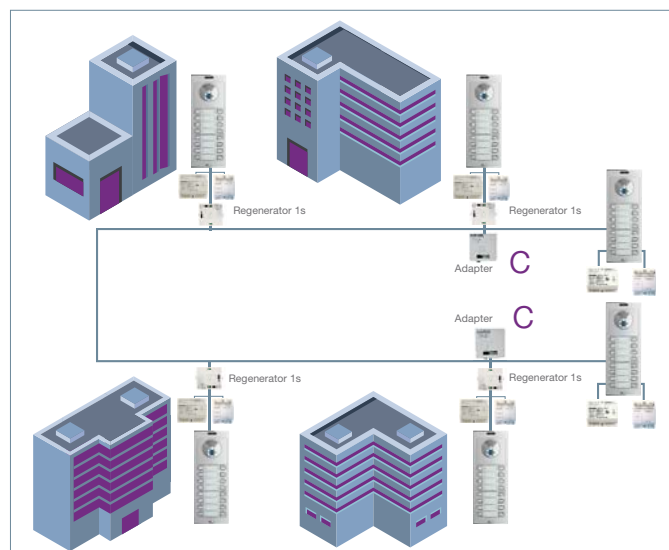

Image 2.2

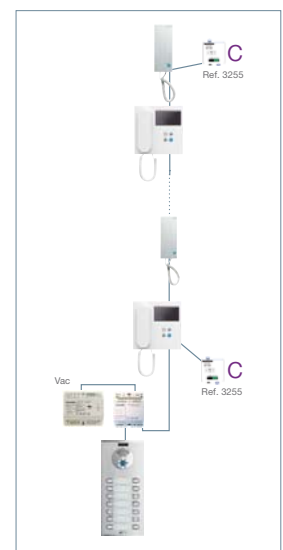

Image 2.3

KEY SYSTEM ELEMENTS

UNIT 2 WHAT MODE SHOULD I CONFIGURE: "C" or "A"?

- Cascade installations: all adapters are configured as "C".
- INSTALLATIONS con miscellaneous terminals por floor.
- In the first bifurcation, starting from the street panel, we configure it in "C".
- In the final bifurcation of each shunt, the furthest away from the street panel must be configured in "A".
- When a bus does not have terminals: the adapters are configured as "C" at the beginning and at the end of the bus.

UNIT 3 ¿QUÉ DEVICES USE COMO UN LINE ADAPTER?

Besides the Line adapter Ref. 3255, other Duox devices also incorporate the option of being used as line adapters:

LINE ADAPTER (Ref. 3255)

It has a jumper (JP1) that allows you to configure it as "C" or "A". The device includes a connection terminal to be installed in parallel to the installation cable.

REGENERATORS

Regenerator 1S (Ref. 3256). Line adapter integrated to the entrance, with a configurable adaptation ("C", "A" or "not adapted") via the JP1 jumper. The default configuration is "C"; if not requiring adaptation remove the jumper (NO TERM).

Regenerator 2S (Ref. 3253). Line adapter integrated to the entrance, with configurable adaptation ("C", "A" or "not adapted") with the micro-switch SW2. The default configuration is "C"; if not requiring adaptation remove the jumper (NO TERM).

Multichannel regenerator 1S (Ref. 3256). Line adapter integrated to the entrance, with a configurable adaptation ("C", "A" or "not adapted") with the jumper JP1. The default configuration is "C"; if not required to adapt, remove the jumper (NO TERM).

DUOX AMPLIFIER

Line adapter integrated to the bus output, with a configurable adaptation ("C", or "not adapted") via the JP2 jumper. The default configuration is "not adapted" (TERM OFF).

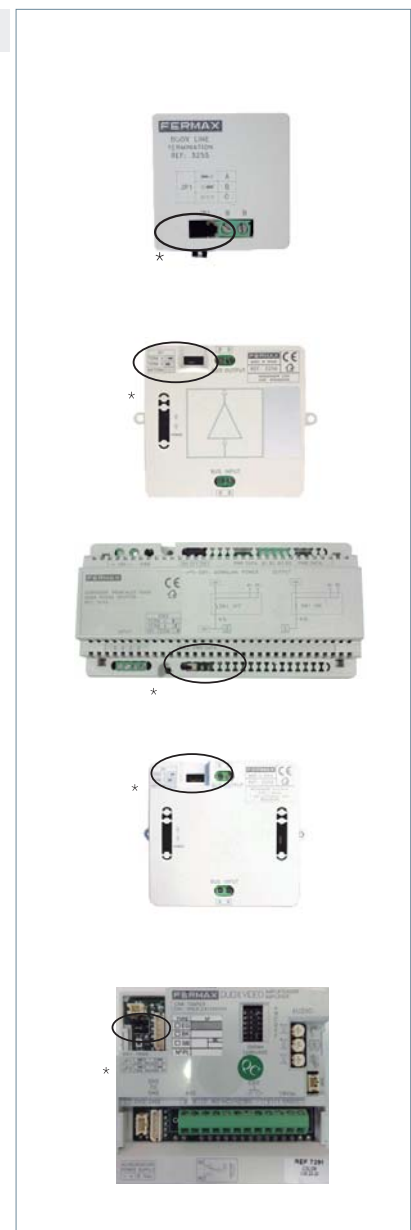

* This indicates the jumper/micro-switch position selecting the type of adapter.



BASIC DUOX INSTALLATION

CONSIDERATIONS ON DUOX WIRING

DUOX is characterized by its flexibility in the use of different cable types. In renovations, **the existing cable works** in old entry and video entry installations. Some cables supported by DUOX are:

- Parallel
- UTP
- 5 wire cable
- Installations 4+N

For optimal operations, we recommend using **2x1mm² parallel cable** (Ref. 5925).
Minimum cable section DUOX 0.22mm²

It is preferable to avoid:

1. Unipolar cable or loose wires, (electric cable installations).
2. Changing cable type or section throughout the installation.
3. Doubling cables (joining 2 pairs to increase section).
4. Conductors of different lengths.

Use a cable with a greater section than recommended does not guarantee improved system performance.

BASIC INSTALLATION

A Duox basic installation is one with only the main elements:

- Entry panel keypad
- Power set
- Adapter

The maximum distances between elements and the maximum number of terminals per distribution are determined by the cable section and number of shunts.

See the DUOX Basic/Advanced Installation Design to obtain guidelines and design tables.

In a basic Duox installation we recommend not mixing cables with different characteristics (section, braided, etc).

All installations exceeding the Duox basic installation's limits must **be broken down into smaller installations** via the use of regenerators. This way a large and complex installation is approached as the sum of N basic installations, interconnected by Regenerators.

In the following pages we see tables with distances and diagrams for basic DUOX installations.

EXAMPLE OF THE BASIC INSTALLATION DUOX. 1 SHUNT

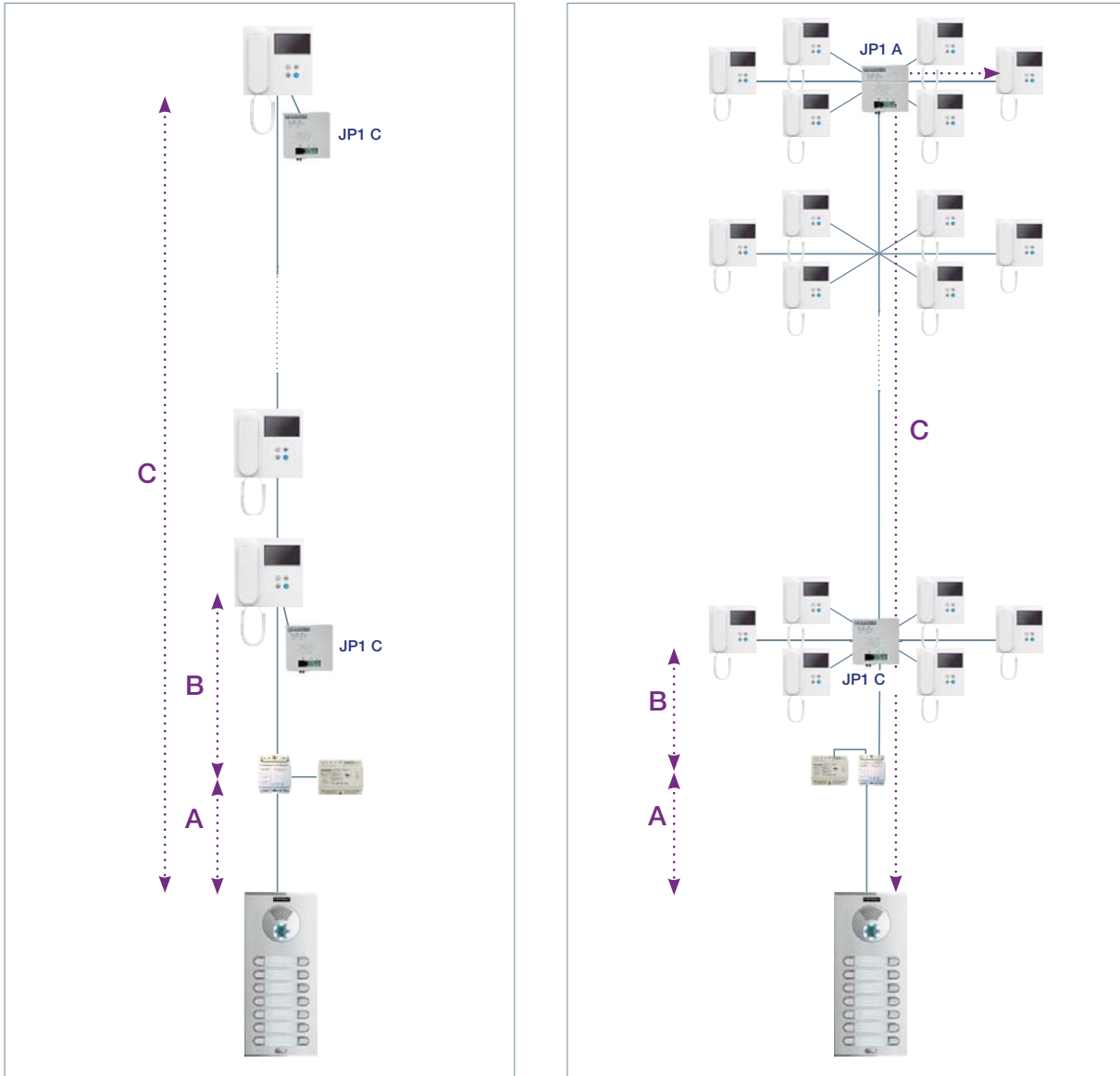

Description	Cable section	UP TO 40 TERMINALS				UP TO 100 TERMINALS (only 1mm ² cable) UP TO 80 TERMINALS	
		CASCADE	2 DERIVA.	4 DERIVA.	6 DERIVA.	4 DERIVA.	
A Street panel - Power Set	2 x 1 mm ² Ref. 5925	30 m	30 m	20 m	20 m	20 m	
	2 x 0.5 mm ²	20 m	20 m	20 m	20 m	15 m	
	2 x 0.22 mm ²	15 m	15 m	15 m	15 m	10 m	
B Power set - first terminal/derivation	2 x 1 mm ² Ref. 5925	15 m				15 m	
	2 x 0.5 mm ²	15 m				15 m	
	2 x 0.22 mm ²	15 m				15 m	
C Street panel - Furthest terminal	2 x 1 mm ² Ref. 5925	162 m	122 m	82 m	73 m	127 m	
	2 x 0.5 mm ²	152 m	112 m	82 m	73 m	122 m	
	2 x 0.22 mm ²	147 m	107 m	77 m	68 m	117 m	

IMPORTANT: Maximum distance between the derivation and the terminal is 20 meters, for greater distance consider an additional shunt. Estimated distance between 3 meter floors.



BASIC DUOX INSTALLATION

EXAMPLE OF THE BASIC INSTALLATION DUOX. 2 SHUNTS

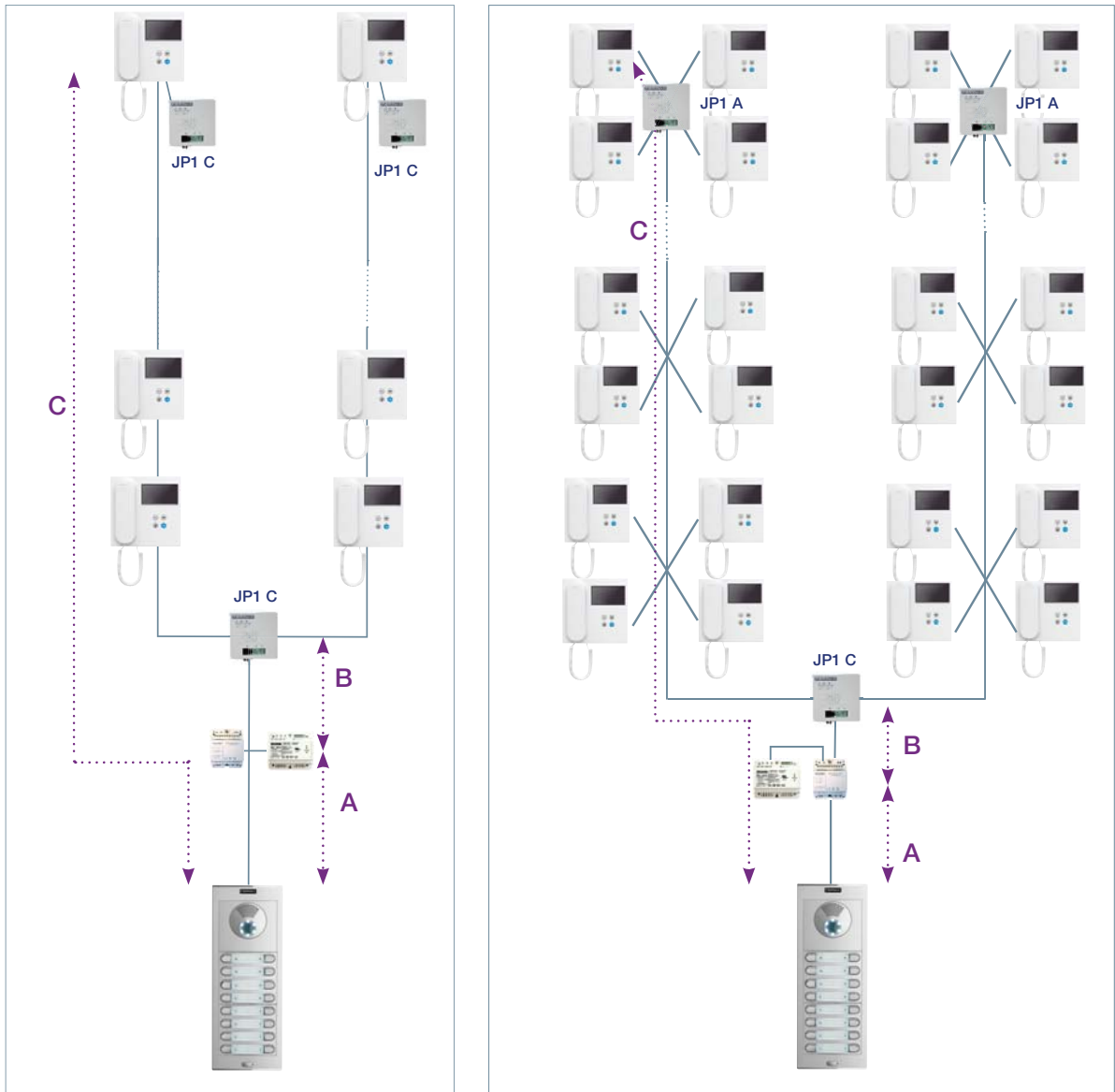

Description		UP TO 40 TERMINALS				UP TO 100 TERMINALS (only 1mm ² cable) UP TO 80 TERMINALS
		Cable section	CASCADE	2 DERIVA.	4 DERIVA.	4 DERIVA.
A	Street panel - Power Set	2 x 1 mm ² Ref. 5925	15 m	20 m	20 m	20 m
		2 x 0.5 mm ²	15 m	20 m	15 m	10 m
		2 x 0.22 mm ²	10 m	10 m	10 m	10 m
B	Power set - first bifurcation	2 x 1 mm ² Ref. 5925	5 m			5 m
		2 x 0.5 mm ²	5 m			5 m
		2 x 0.22 mm ²	5 m			5 m
C	Street panel - Furthest terminal	2 x 1 mm ² Ref. 5925	77 m	72 m	57 m	84 m
		2 x 0.5 mm ²	77 m	72 m	57 m	74 m
		2 x 0.22 mm ²	72 m	62 m	47 m	74 m

IMPORTANT: Maximum distance between the derivation and the terminal is 20 meters, for greater distance consider an additional shunt. Estimated distance between 3 meter floors.

EXAMPLE OF THE BASIC INSTALLATION DUOX. 3 SHUNTS

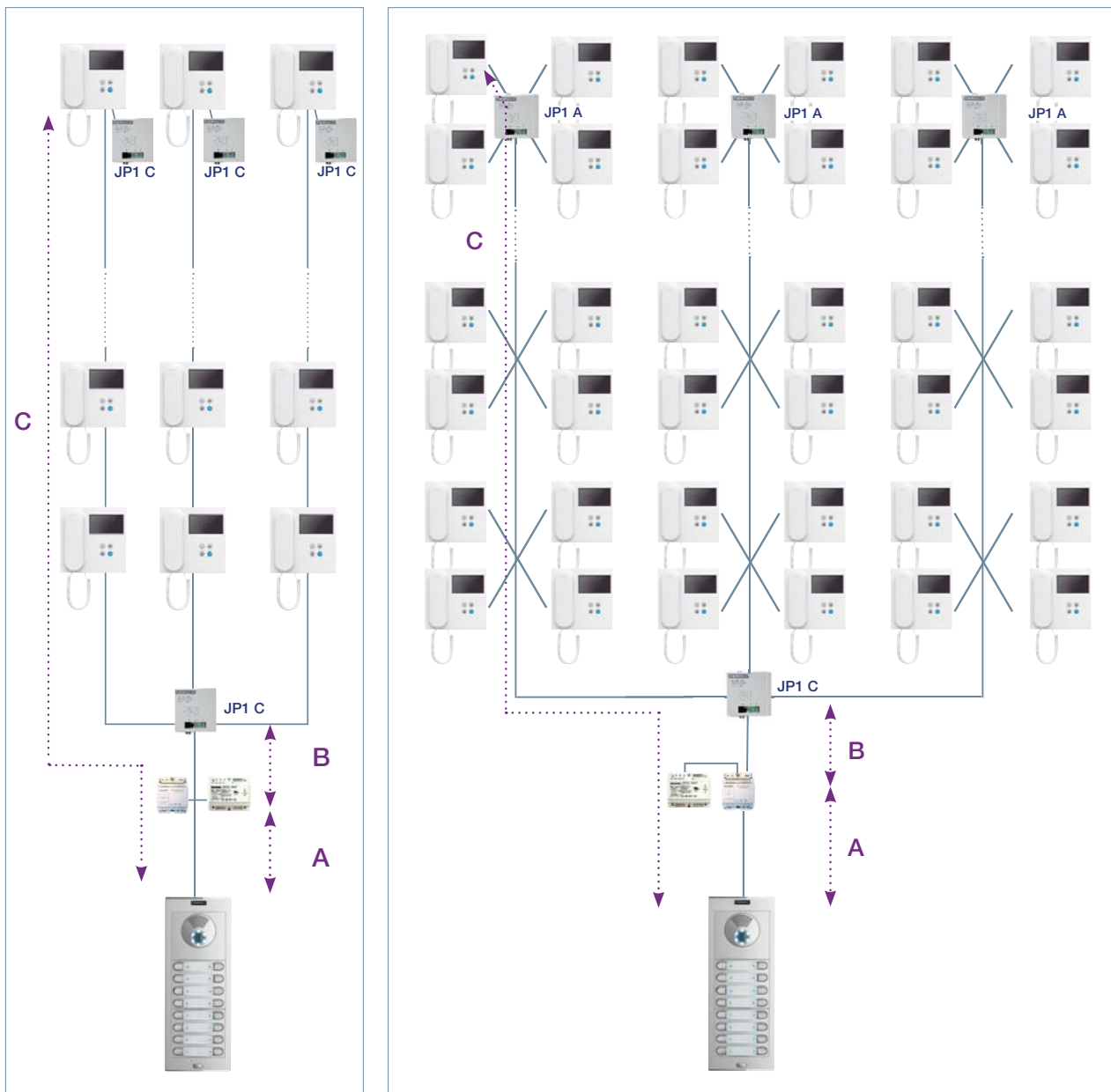

Description		UP TO 40 TERMINALS			
		Cable section	CASCADE	2 DERIVA.	4 DERIVA.
A	Street panel - Power Set	2 x 1 mm ² Ref. 5925		10 m	
		2 x 0.5 mm ²		10 m	
		2 x 0.22 mm ²		10 m	
B	Power set - first bifurcation	2 x 1 mm ² Ref. 5925			
		2 x 0.5 mm ²		5 m	
		2 x 0.22 mm ²			
C	Street panel - Furthest terminal	2 x 1 mm ² Ref. 5925	72 m	62 m	47 m
		2 x 0.5 mm ²	72 m	62 m	47 m
		2 x 0.22 mm ²	72 m	62 m	47 m

IMPORTANT: Maximum distance between the derivation and the terminal is 20 meters, for greater distance consider an additional shunt. Estimated distance between 3 meter floors.



BASIC DUOX INSTALLATION

EXAMPLE OF THE BASIC INSTALLATION DUOX. 4 SHUNTS

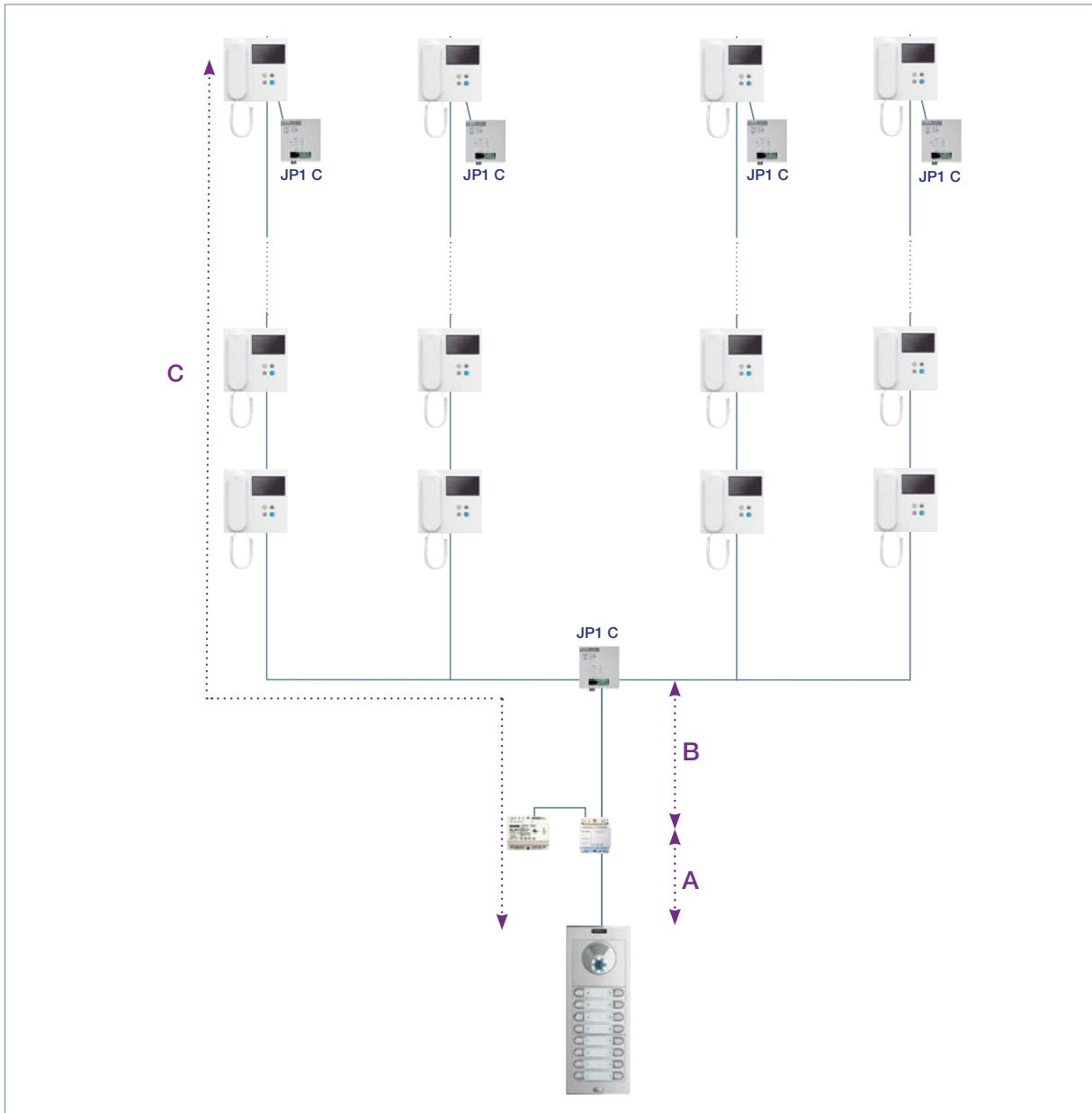

Description		UP TO 30 TERMINALS	
		Cable section	Cascade
A	Street panel - Power Set	2 x 1 mm ² Ref. 5925	10 m
		2 x 0.5 mm ²	10 m
		2 x 0.22 mm ²	N/A
B	Power set - first bifurcation	2 x 1 mm ² Ref. 5925	5 m
		2 x 0.5 mm ²	
		2 x 0.22 mm ²	
C	Street panel - Furthest terminal	2 x 1 mm ² Ref. 5925	42 m
		2 x 0.5 mm ²	42 m
		2 x 0.22 mm ²	N/A

IMPORTANT: Maximum distance between the derivation and the terminal is 20 meters, for greater distance consider an additional shunt. Estimated distance between 3 meter floors.



ADVANCED DUOX INSTALLATION



You can create greater sized or complex installations to those shown in these diagrams and tables in the previous pages.

Because of the regenerators, you can divide an advanced installation into various basic installations.

NECESSARY ELEMENTS FOR ADVANCED INSTALLATIONS

DUOX REGENERATOR

This element can regenerate the DUOX signal completely, and is bidirectional, doing so both input-output direction and output-input direction. Besides regenerating the signal, it also isolates the installation it is connected to at an electric level.

You can use as many regenerators as necessary in the parallel installation, keeping in mind that **the maximum number of regenerators to be installed in series is 5.**

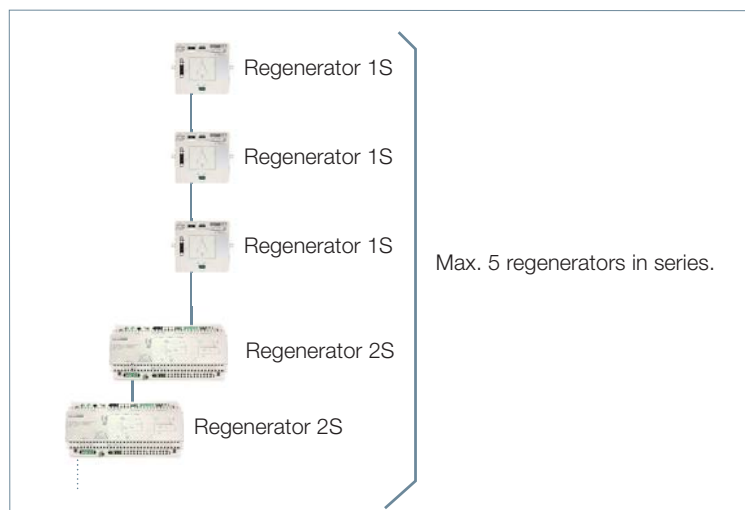

You can only use the Regenerator in points of the installation where the signal's quality is sufficient to connect a monitor and the communication quality is good.

You must keep in mind that if in the regenerator's output there are several risers connected in parallel, these are isolated from the input but not to each other.

The regenerator also has **a line adapter integrated in its input**, which can be used or not, if necessary, relative to the line adapters usage criteria. This **integrated line adapter** can be configured as "A" or "C". Upon installing a regenerator, you need to include the line adapters according to the general installation criteria.

Use the regenerator to extend panel-power set-first bifurcation distances

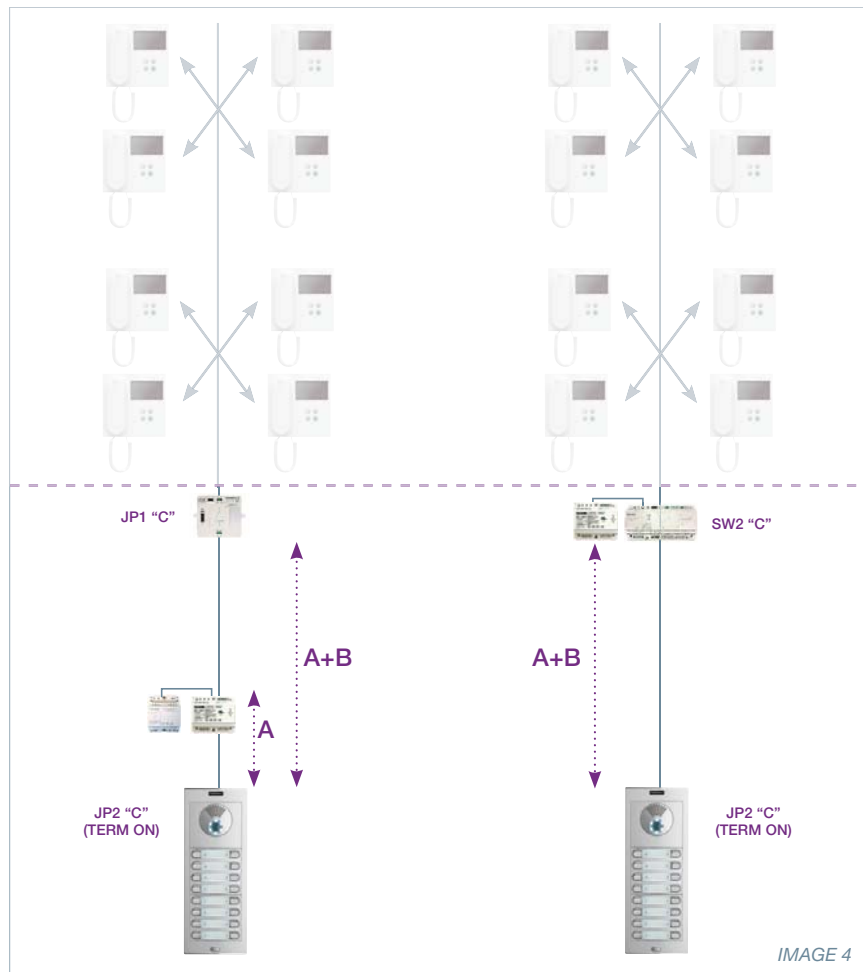

The maximum distances can be expanded according to that indicated in the following table:

Description		Cable section	Distance (in meters)
A	Maximum distance street panel - Power Set	2 x 1 mm ²	90 m
		2 x 0.5 mm ²	60 m
		2 x 0.22 mm ²	20 m
A+B	Maximum distance street panel - Regenerator	2 x 1 mm ²	200 m
		2 x 0.5 mm ²	100 m
		2 x 0.22 mm ²	45 m



Regenerator Models

There are different regenerator models to cover the particular needs of each installation. Below we show the different models, specifics and recommendations for using each one.

DUOX REGENERATOR 1S (Ref. 3256)

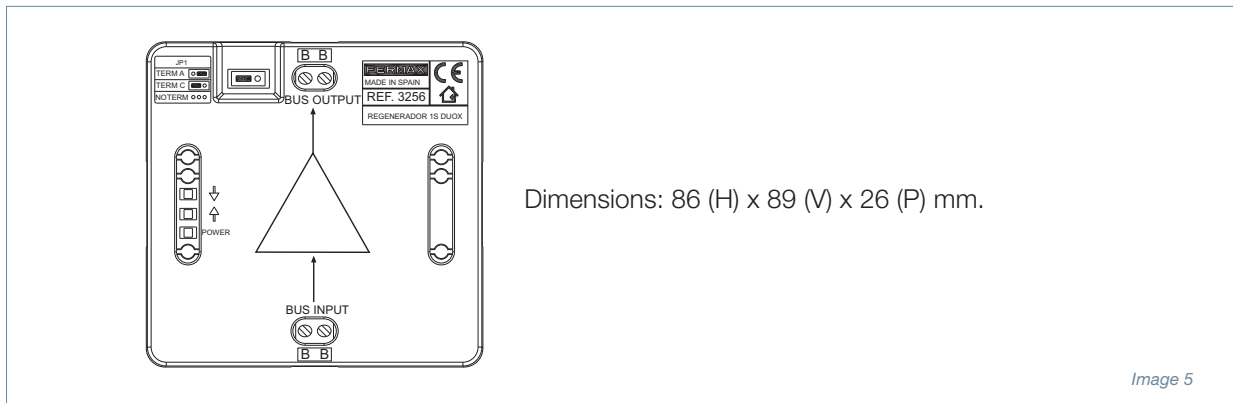

It has 1 input and 1 output, it is powered by the bus DUOX from any of the two sides.

The 1S regenerator regenerates the data, but it does not let the power pass, so the sections of both sides require their own power set. Besides, the sections connected to the input and output are protected from short-circuits, surges and signal reflections, mutually.

As shown in Image 6, only if there are no terminals between the regenerators, no power sets are needed.

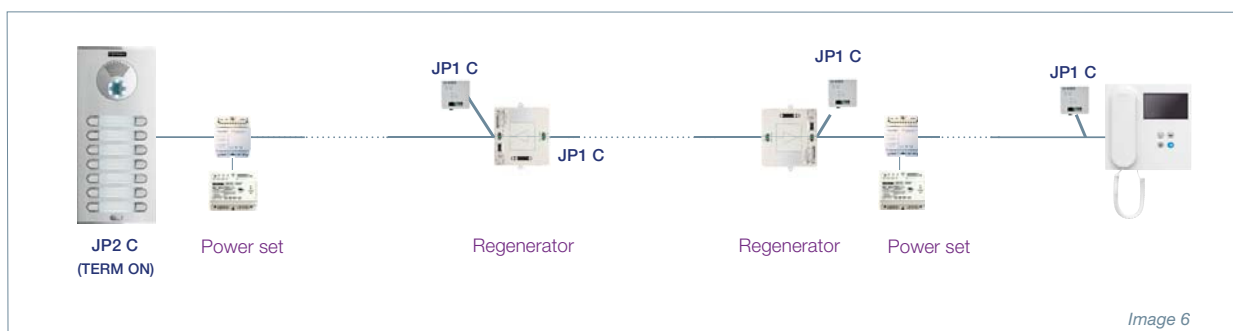

We recommend using the DUOX 1S regenerator:

- To increase the distance from the panel and power set.
- To increase the distance between panels and terminals or in a riser.
- To increase the num. of terminals in the installation.
- When necessary or recommended, isolate between the sections, for example:
 - when there is a complex topology (GE at various registers, derivations or BI).
 - in a change of section or cable type.

Examples of Regenerator uses 1S:

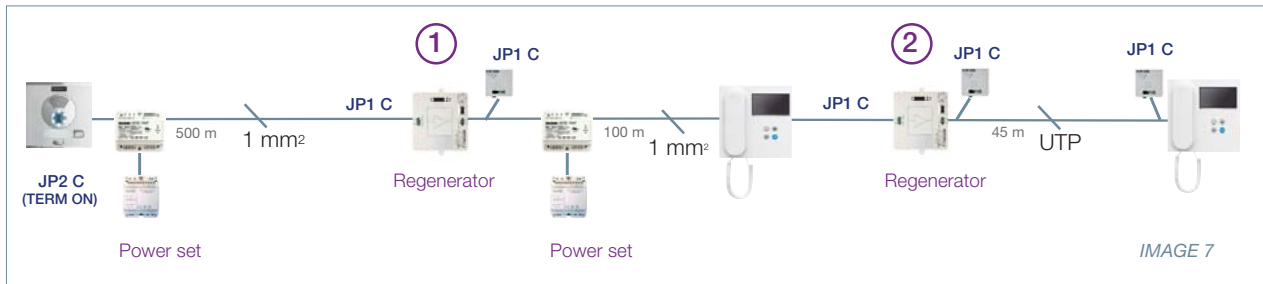

By looking at the image 7 and following the bus from the street panel we see the following:

- 1- The **first** regenerator 1S is installed due to there being 500 meters of distance without terminals From the panel Both the regenerator 1S and street panel are configured in C-C. You need to add a line adapter in C at the first regenerator’s output, since this only has an adapter configured to the input. After the regenerator we add a power set to power the first monitor
- 2- We will install a **second** regenerator 1S ya que del primer monitor al segundo hay un change in section (from 1mm² to UTP) and a distance of 45m. The entrance of the regenerator is configured as “C” and at the output we install a line adapter configured in “C”. We will install a power set and the last adapter of the line configured in "C" in the monitor.

DUOX REGENERATOR 2S (Ref. 3253)

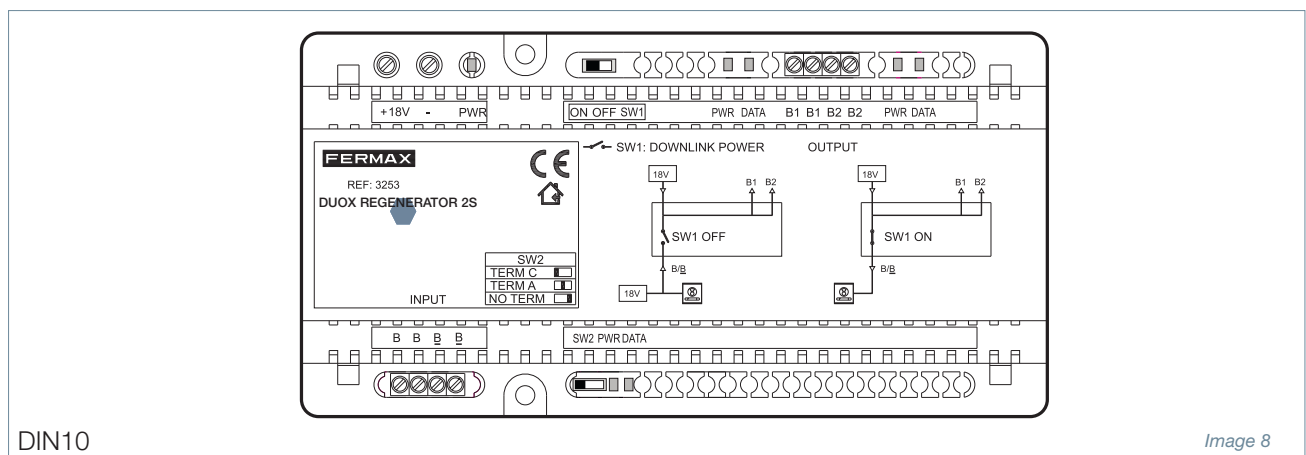

The regenerator 3253 has 2 outputs and 1 input. At an electric level it isolates the three installation segments to those connected (the input and output). If in one of the 2S regenerator’s outputs various risers are connected in parallel, these cannot be isolated from each other.



This requires a power source, but not a DUOX filter (Ref. 3244). You can use this power source to supply current to other elements in the installation of the following forms: 1 street panel connected to the input and up to 20 terminals maximum at each output (independent of there being a panel or not).

When a 2S regenerator is installed, the terminals must be connected in its outputs. **There shouldn't be terminals between the panel and regenerator 2S.**

We recommend using the DUOX 2S regenerator in the same cases as the 1S regenerator, along with:

- If you need to separate or increase the num. of risers.
- If you can't install a power source per installation section, and the 2S regenerator allows you to send power.

DUOX 1S MULTICHANNEL REGENERATOR (Ref. 3259)

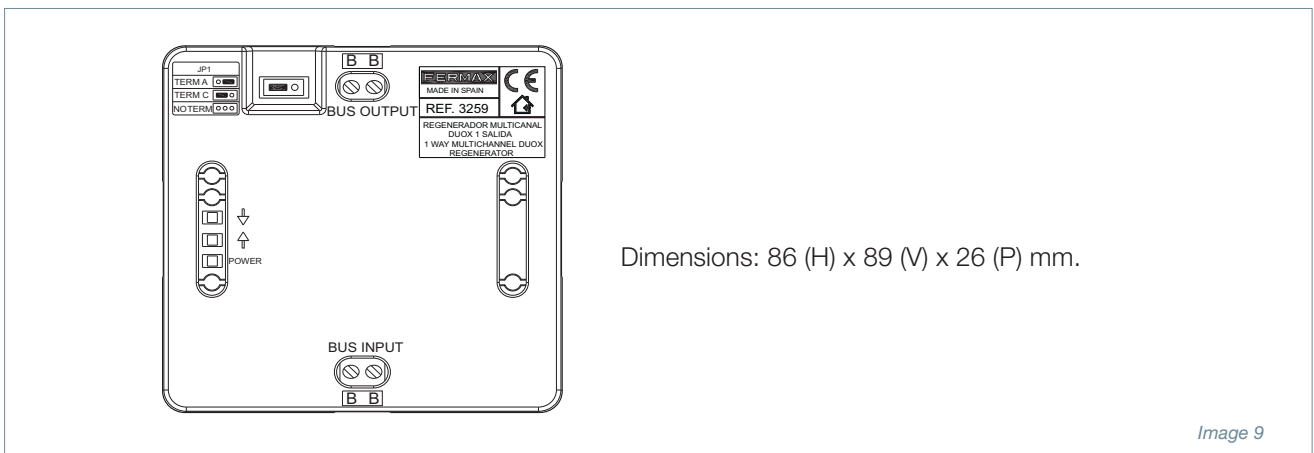

The regenerator 3259 is designed to be used in installations with a general entrance and several blocks, generating an additional call channel per block, and holding as many simultaneous conversations as blocks: with one regenerator Ref.3259 and its own entry panel keypad. The remaining characteristics are similar to Ref. 3256.

It can also be used in installations with a general entrance to single-family homes with a street panel; in this case it will generate an additional call channel per home, being able to hold as many simultaneous conversations as on the Ref. 3259 and its street panel.

The multichannel regenerator regenerates the data, but it does not let the power pass, so the sections of both sides require their own power set.

Only use **the multichannel DUOX 1S regenerator** when 1 additional communication channel is needed for the interior block or home with street panel.

Examples of 1S Multichannel Regenerator uses :

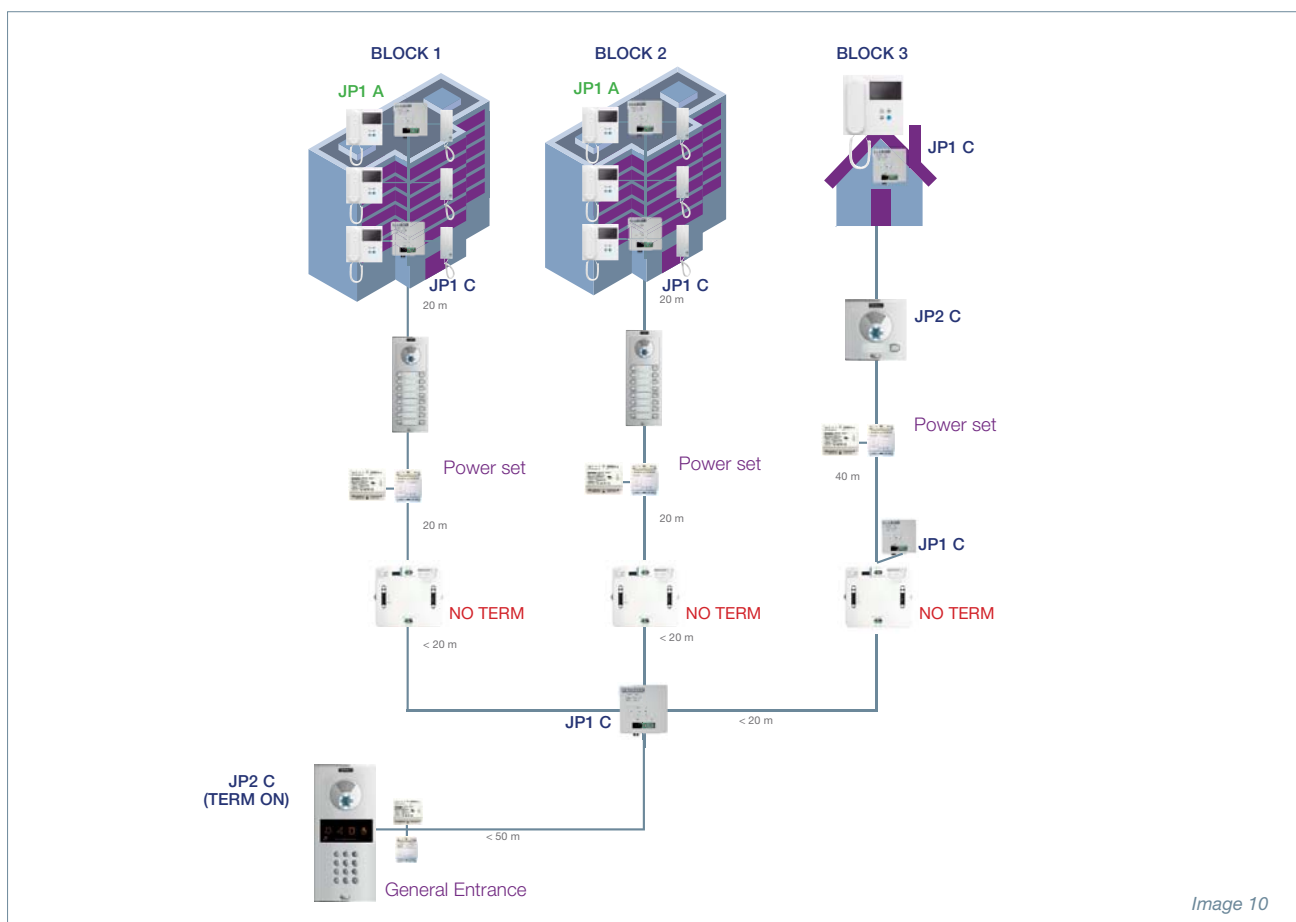

In Image 10 we install a 1S multichannel regenerator per block, always connecting the block to the “BUS OUTPUT” and “BUS INPUT” to the remaining installation. This way we provide an additional conversation channel per each interior block.

In the example’s image, you can see the following communications:

- Block 1 panel with one of the homes in Block 1.
- General entrance with one of the homes in Block 2.
- Block 3 panel with one of the homes in Block 3.



COMPARATIVE BETWEEN REGENERATORS

The main difference between regenerators, besides its size and format, consists in the number of outputs each one has.

The other big difference between these is in the power: while the 2S regenerator has 2 terminals to directly power it, regenerator 1S or the multichannel 1S regenerator do not have terminals to connect them to a power source and it takes it from the DUOX bus.

TABLE 2. COMPARATIVE BETWEEN REGENERATORS

	Regenerator 1 Output	Regenerator 2 Outputs	Multichannel regenerator
	Ref. 3256	Ref. 3253	Ref. 3259
Size / Format	86 x 89 mm	DIN 10	86 x 89 mm
Inputs	1	1	1
Outputs	1	2	1
Bus Power	Supply	Bus Power	Supply
Main use	Regenerate / isolate	Regenerate / isolate / shunts	Regenerate / isolate / additional channel

DUOX RELAY Ref. 3257

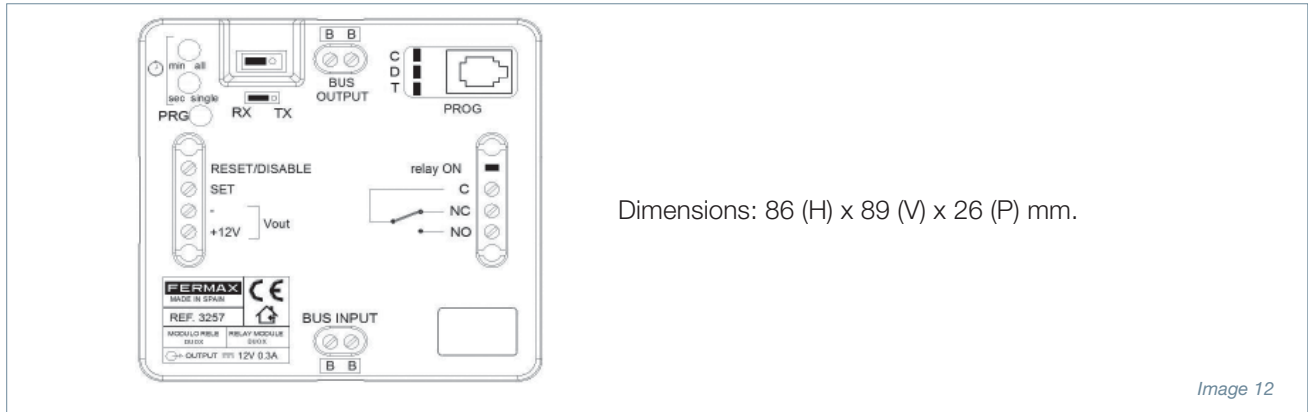

The relay is powered by the DUOX bus and can be installed in any part of the bus. You can install one or several relays: by apartments, block or installation. It is programmed from the relay's pushbuttons, not requiring additional programming elements, even though it could be configured with the DUOX programmer.

It has a power free relay (up to 3A) and also a 12Vdc output (max consumption 300mA). The activation time is configurable from 1 to 120 seconds, from 1 to 120 minutes or bistable.

The relay has several **operating configuration modes**:

1- **RX Mode**. The relay **activates the output** when it receives the programmed command.

The regular functions can be:

- Activation of the relay upon opening.
- Activation of the relay upon generating a call to home from the panel.
- Activation of the relay upon receiving a call to the guard unit.
- Activation of the relay upon self-start.
- Activation or deactivation of the relay upon activating relay F1.
- Activation or deactivation of the relay upon activating relay F2.
- Activation or deactivation of the activate/deactivate relay from "SET" and "-".

2- **TX Mode**. In this mode the relay **does not activate its output**, allowing for other functions from a pushbutton connected between "SET" and "-".

- Lock-release function upon receiving a call.
- Lock-release function in configured panel.
- Guard-unit call function.
- Activate or deactivate the f1 relay function.
- Activate or deactivate the F2 relay function.
- Activate or deactivate the remote relay.
- Doormatic function.

These functions are found detailed in the Duox relay manual.



DUOX INSTALLATIONS DESIGN

DESIGN OF THE DUOX BASIC INSTALLATION
DESIGN OF THE DUOX ADVANCED INSTALLATION

D DESIGN OF THE DUOX INSTALLATION

DESIGN PROCEDURE

Like any system, in Duox you can design any installation with a step-by-step procedure. The following diagram shows the steps to follow to properly design any DUOX installation. Before starting, it can be of great use to make a diagram or blueprint of the installation.

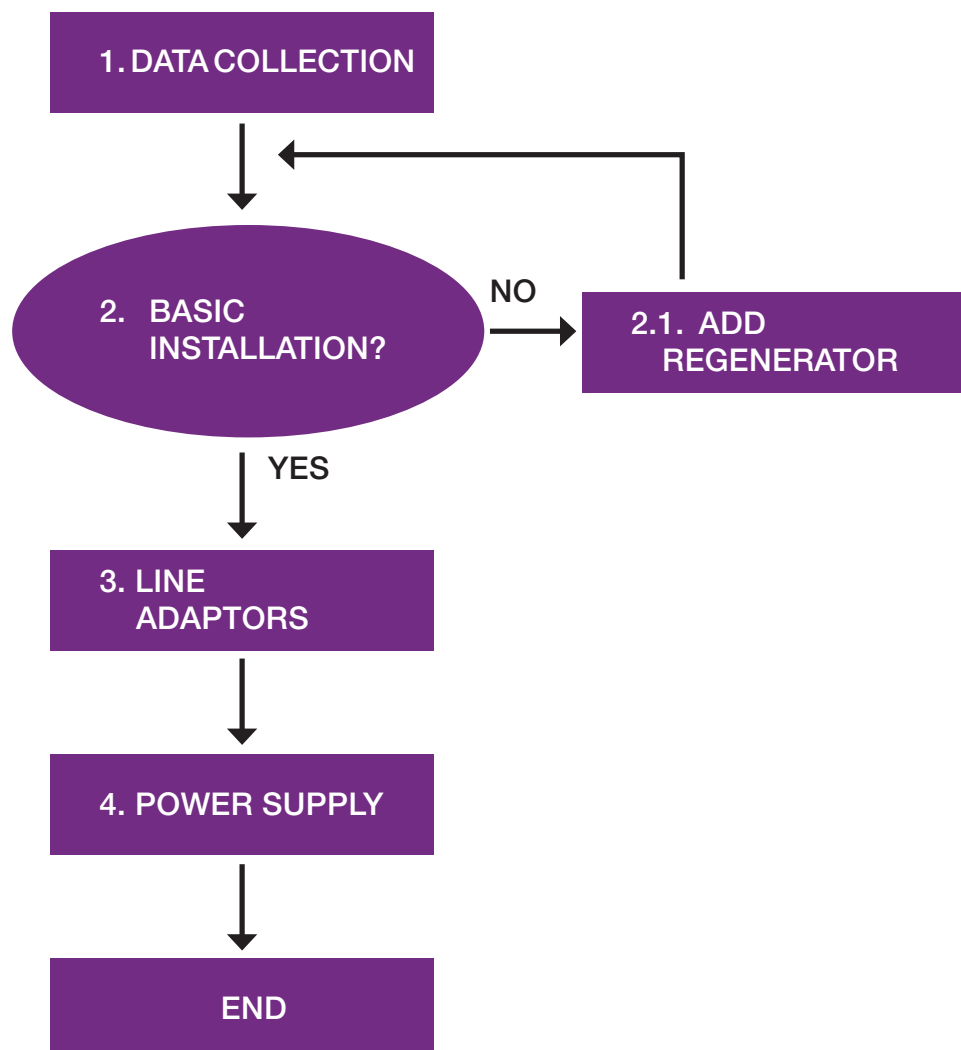

D DESIGN OF THE DUOX INSTALLATION

STEP 1 DATA COLLECTION

Like in any system, to properly design any DUOX installation, first you have to collect certain projection information, like for example, the distances between elements or cable type, as shown in the following table:

No. of panels.		
Number of terminals per residence.		
Types of cable		
Topology	Distances	From the panel to the first bifurcation/floor
		Between bifurcations
		Maximum derivation distance
		From the panel to the last derivation
		From the panel to the power set
Num. shunts		
Num. of bifurcations/floors		
Num. of derivations per bifurcation		

NOMENCLATURE:

←····· Shunt

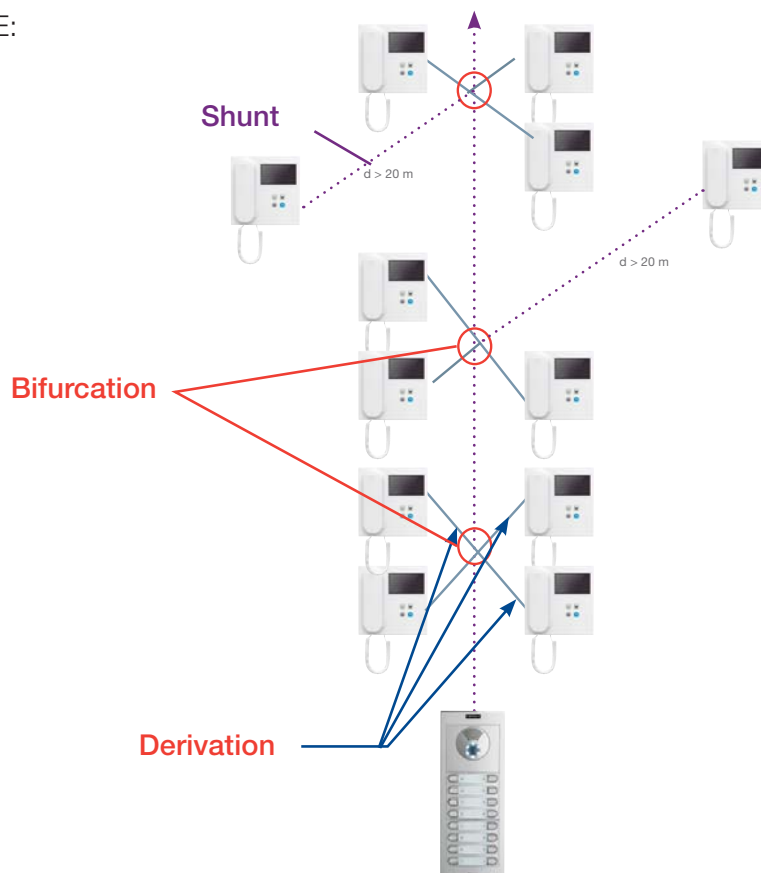

Image 13

STEP 2 CHECK IF IT IS A BASIC INSTALLATION

The following step would be to check if the installation is included in one of the tables and diagrams of a Basic Installation (see pages 14-18)

If the installation is within that reflected in the Basic Installation, you can continue to Step 3.

If the installation does not correspond to the diagrams or tables' values, you need to advance to Step 2.1.

STEP 2.1 ADD REGENERATORS

If the topology is not in the Basic Installation tables, you need to add regenerators to divide the installation into more simple installations. These are some of the usage criteria for the regenerators:

- i. If there are several interior blocks to a general entrance, start isolating the blocks.
- ii. If within a block there are more shunts than suitable according to the number of monitors per derivation, use a regenerator to reduce the number of shunts.
- iii. When the num. of terminals exceeds the maximum in a shunt.
- iv. When there are significant changes in cross-section or long cable distances.

Once the previous criteria are applied, return to **STEP 2** with each resulting installation from dividing the complex installation via regenerators.

STEP 3 CHECK IF YOU NEED LINE ADAPTERS

Define the necessary line adapters

- Where to install them?

- How? "C", "A"

- Do you need a line adapter or can we make the most of one from another device in the installation?

Can you find more details on the use of the line adapters in page 10.

STEP 4 CHECK HOW MANY POWER SETS ARE NECESSARY

Relative to the number of panels and terminals, along with the distances and typologies, calculate how many power sets are necessary. A power set composed of a filter Ref. 3244 and power source Ref. 4830 can power up to 1 street panel and 40 monitors. We also must keep in mind the distances between the power set and last terminal (see TABLE 1 pg. 10)



DESIGN OF THE DUOX INSTALLATION

EXAMPLE 1

Buildings with 6 floors and 4 homes per floor in a single shunt. Existing cable of $2 \times 0.5 \text{ mm}^2$ section. La distance from outdoor panel up to la power source es de 20 m, 10 m más a la first floor. The furthest terminal from the plant register is 20 m.

STEP 1

DATA COLLECTION

Num. of panels.		1
Num. of terminals		24
Type of cable		$2 \times 0.5 \text{ mm}^2$
Distances	From the panel to the first bifurcation/floor	30 m
	Between bifurcations/floors (regular distance)	3 m
	Maximum derivation distance	20 m
	From the panel to the last monitor $(30\text{m}+5 \times 3\text{m}+20\text{m})=$	65 m
	From the panel to the power set	30 m
Topology	Num. of shunts	1
	Number of bifurcation points.	6
	Number of derivations per bifurcation	4

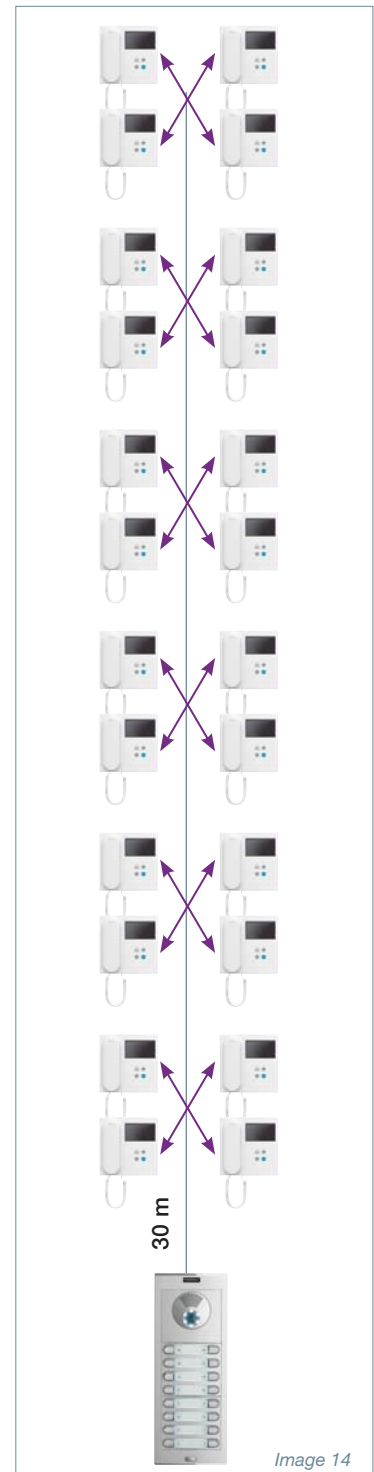

Image 14

STEP 2 CHECK IF IT IS A BASIC INSTALLATION

Look on the Basic Installation Table 1 Shunt for 2x0.5mm² cable.
 Since distances of the Data Collection are the same or less than those appearing in the table on pg.15, se verifica que se trata de una Basic Installation y que no es necesario install regenerators.

STEP 3 CHECK IF YOU NEED LINE ADAPTERS

- ① - 1x line adapter in the first bifurcation/plant, in "C". 1x 3255.
- ② - 1x line adapter in the last bifurcation/plant, in "A". 1x 3255.

STEP 4 CHECK HOW MANY POWER SETS ARE NECESSARY

Since the installation is composed of 24 monitors, you need 1 power set (composed of a source Ref. 4812 and filter 3244)
 You also must check that the voltage reaching the last terminals are correct. For this, check table 1 pg. 10.

In this installation the distance from the source to the last bifurcation/floor is 25 m.

$$25m = 10m \text{ (distance set to 1st floor)} + 5 \times 3m \text{ (distance from the 1st floor to the 6th)}$$

Since the distance is the same as the maximum indicated in Table 1. pg.10. you can assume the installation diagram is correct, and make the materials list.

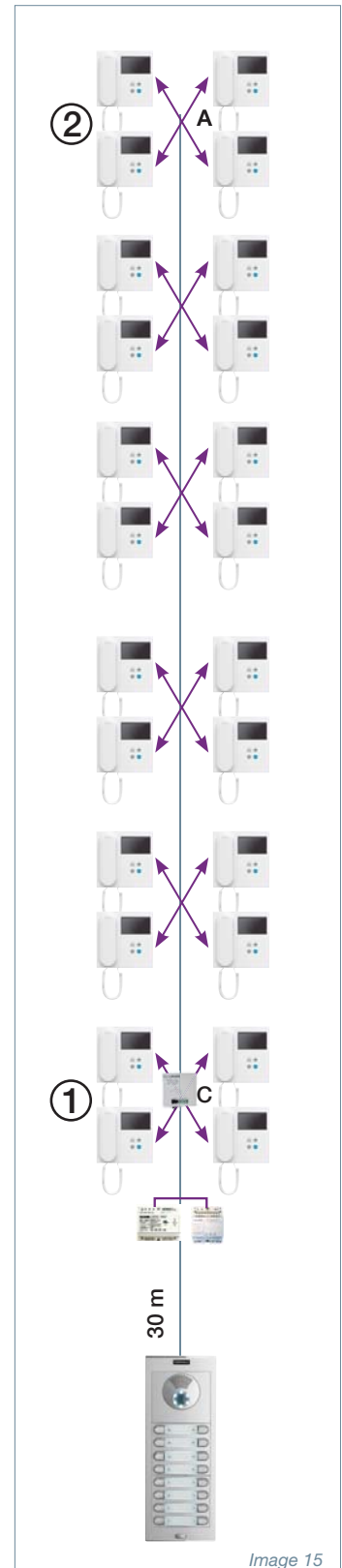
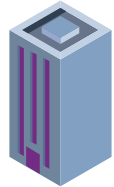

Image 15

D DESIGN OF THE DUOX INSTALLATION

EXAMPLE 2

Buildings with 6 floors and 4 homes per floor in a single shunt.
Existing cable of 2x0.5mm² section. The distance from the street panel to the power sources is 60m, 10 m more to the first floor. The furthest terminal from the plant register is 20 m.



STEP 1 DATA COLLECTION

Num. of panels.		1
Num. of terminals		24
Type of cable		2x0.5 mm²
Distances	From the panel to the first bifurcation/floor	70 m
	Between bifurcations/floors (regular distance)	3 m
	Maximum derivation distance	20 m
	From the panel to the last monitor	105 m
	(70m+5x3m+20m)=	30 m
Topology	From the panel to the power set	
	Num. of shunts	1
	Number of bifurcation points.	6
	Number of derivations per bifurcation	4

STEP 2 CHECK IF IT IS A BASIC INSTALLATION

Look on the Basic Installation Table 1 Shunt for 2x0.5mm² cable.

- Maximum distance from street panel to the power set in table = 20m
- Distance from street panel to the power set in Data Collection = 60m

The installation does not include the table so you have to study the use of a regenerator (STEP 2.1).

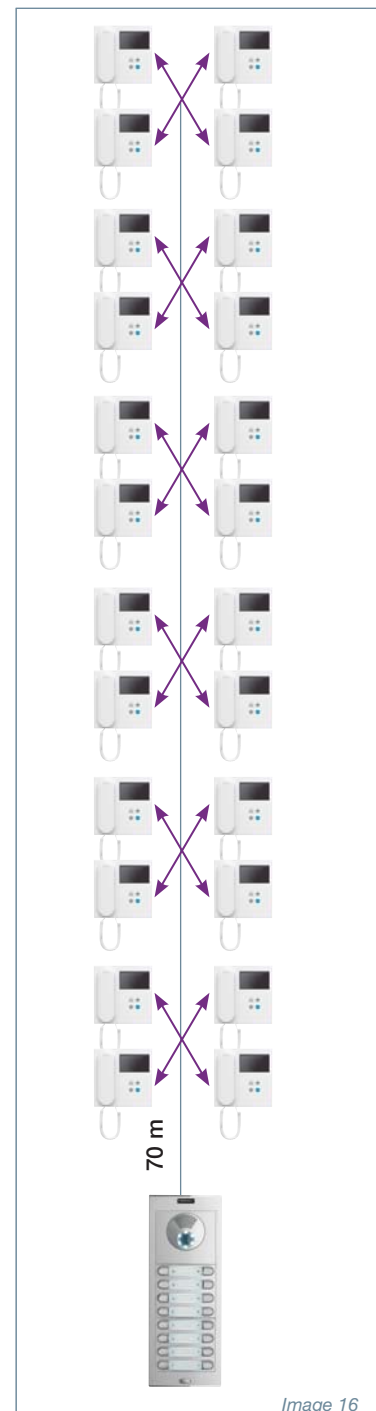

Image 16

UNIT 2.1 ADD REGENERATORS

Since the installation is not in the tables, you need to add regenerators to divide the installation into more simple installations.

Según se indicades en la Table 2 de la pág.26, al add 1 x regenerator Ref. 3256 puede aumentarse la distance general de calle-set de Power Supply up to los 60 m.

The regenerator has divided the installation into TWO SECTIONS, so you must return to step 2 and redo STEPS 2 to 4 with each section.

STEP 2 CHECK IF IT IS A BASIC INSTALLATION

Section 1

(From the street panel to the regenerator/power set 1)
 Installation está incluida en la table de la pág.21, no requiere add regenerators functions.

Section 2.

(From regenerator/power set 2 to the last terminal)
 Look on the Basic Installation Table 1 Shunt for 2x0.5mm² cable, y comprobar que las distances son igual o menor at indicadas, una vez hecho esto, vemos que installation está incluida en las tables, no requiere regeneration.

UNIT 3 CHECK IF YOU NEED LINE ADAPTERS

Section 1

Bus without terminals Place a line adapter at the beginning of the bus (panel) and another at the end (regenerator). They must be configured in Mode C in both ends. See image 4, pg.21.

Since the street panel and regenerator internally incorporate a line adapter, these are used; in the street panel (JP2 in position "TERM ON") and in the regenerator input (JP1 in "C").

Section 2.

You need 2 adapters:

- ①. 1x line adapter in the first bifurcation/plant, in "C". 1x 3255.
- ②. 1x line adapter in the last bifurcation/plant, in "A". 1x 3255.

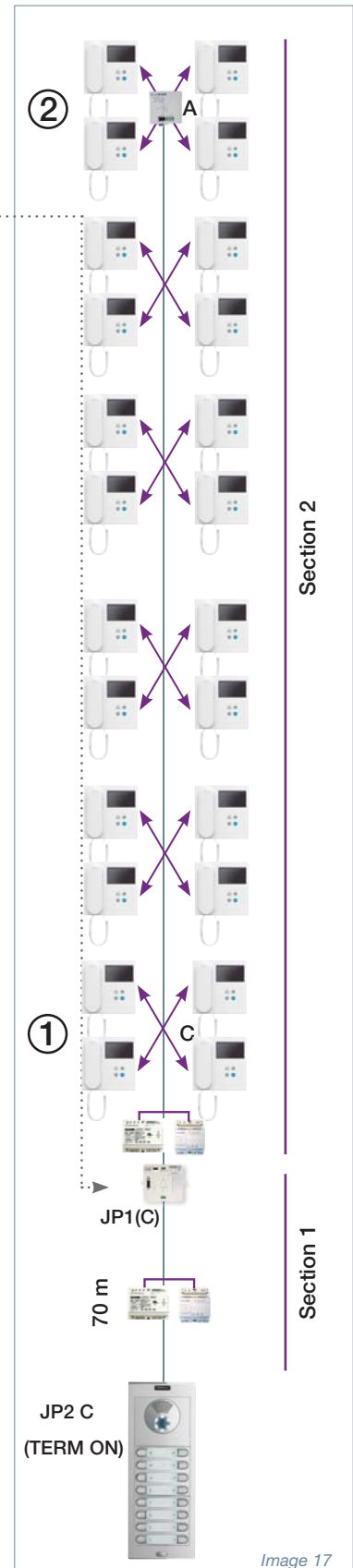



DESIGN OF THE DUOX INSTALLATION

UNIT 4

CHECK HOW MANY POWER SETS ARE NECESSARY

Section 1

The panel requires a power set, which requires a set (Ref. 3244 + Ref. 4812 4812). Via this power set it also powers the regenerator.

Section 2.

Since the installation is composed of 24 monitors, you need 1 power set, composed of a source Ref. 4812 and filter 3244.

You also must check that the voltage reaching the last terminals are correct. For this, check table 1 pg. 10.

In this installation the distance from the source to the last bifurcation/floor is 25 m, $25\text{m}=10\text{m}$ (distance set to 1st floor) + $5 \times 3\text{m}$ (distance from the 1st floor to the 6th).

Since the distance is the same as the maximum indicated in Table 1. pg.10. you can assume the installation diagram is correct, and make the materials list.

EXAMPLE 3

DEVELOPMENT WITH 3 GENERAL ENTRANCES (GE) TO 5 INTERIOR BLOCKS (IB)

Each IB has 3 floors and 6 homes in each floor (all IB are similar). There is a distance of 100m between the GE and the IB3. The distances between each IB and between the IB and the GE are the same. Each IB has a 4 + N system in audio, that is, the existing cable is 5x0.22mm.

STEP 1 DATA COLLECTION

Num. of panels.		7
Num. of terminals		90 (18 in each block)
Types of cable		2x0,22 mm²
Distances interior blocks	From the panel to the first bifurcation/floor	13 m
	Between bifurcations/floors (regular distance)	3 m
	Maximum derivation/floor distance	20 m
	From the panel de block a último monitor	19 m
	From the block panel to the power set	10 m
Distances Residential Complex	From the GE panel to the first bifurcation/IB	20 m
	From the GE1 panel to BI5 (furthest regenerator)	100 m
	From the GE panel to the power set	15 m
Topology	Num. of shunts in development	1
	Num. of shunts in each block	1
	Num. of shunts in the installation	6
	Num. of bifurcations/floors in each IB	3

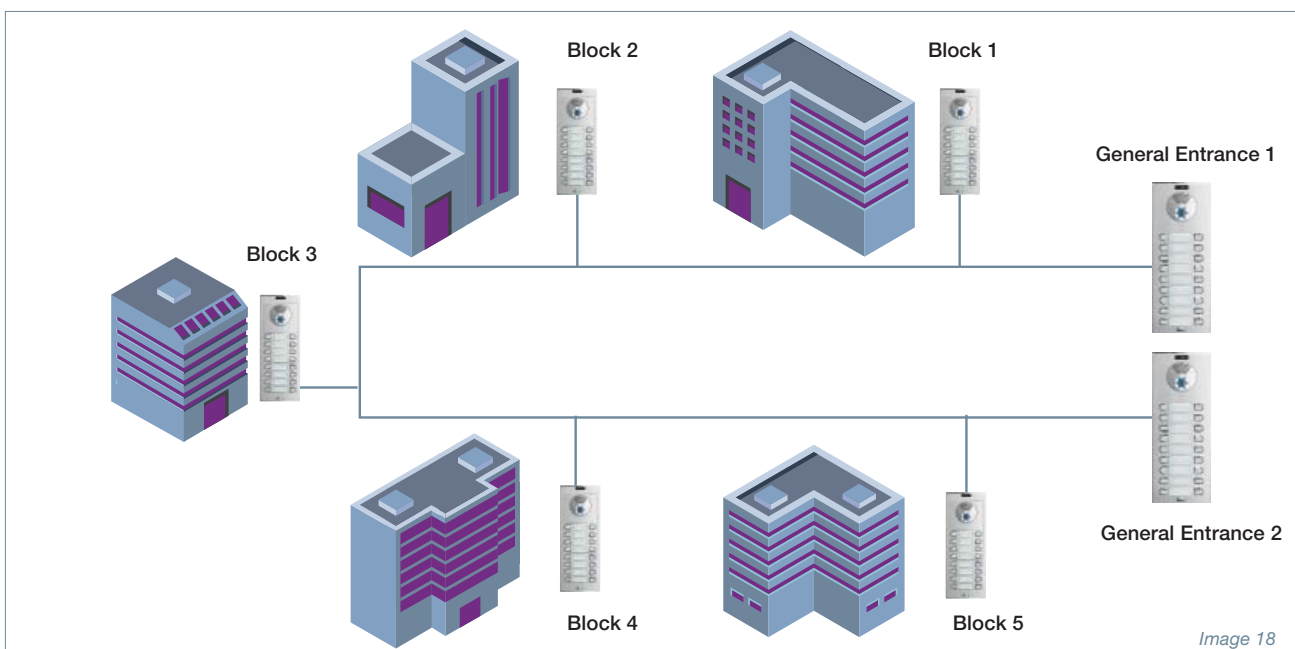

Image 18



DESIGN OF THE DUOX INSTALLATION

STEP 2 CHECK IF IT IS A BASIC INSTALLATION

As indicated in the Data Collection, there are different variables that place it out of the basic Installation specifications, for example, it has 6 shunts in the installation, so it is out of the specifications for a DUOX Basic Installation.

Go on to step 2.1 to deconstruct the installation with regenerators.

UNIT 2.1 ADD REGENERATORS

You add 1x multi-channel regenerator Ref. 3259 in each IB, so as to regenerate and isolate each block and thus study it separately, generating an additional communication channel in each block.

The installation has been divided in SIX SECTIONS: 5 sections corresponding to the 5 IB, plus another section composed of the general entrances and bus joining the blocks. Go back to Step 2 and apply STEPS 2 to 4 in each section.

STEP 2 CHECK IF IT IS A BASIC INSTALLATION

Section 1

(Installation made up of two general entrances, GE1 and GE2).

The installation is within the specifications, involving a 120 m bus without terminals with a street panel at each end.

Sections 2, 3, 4, 5 and 6 (interior blocks, all the same).

No. of panels.		1
Num. of terminals		18
Types of cable		2x0,22 mm²
Distances interior blocks	From the panel to the first bifurcation/floor	13 m
	Between bifurcations/floors (regular distance)	3 m
	Maximum derivation/floor distance	20 m
	From the panel de block a último monitor	19 m
	From the block panel to the power set	10 m
Topology	Num. of shunts	1
	Number of bifurcation points/floors.	3
	Number of derivations per bifurcation/floor.	6

The installation is within the Basic Installation specifications on pg. 14. It doesn't need a regenerator because it is a basic installation.

STEP 3 CHECK IF YOU NEED LINE ADAPTERS

Section 1. . (From GE1 to GE2)

You need 2 adapters:

- ① - 1x line adapter in the first bifurcation/plant, in "C". 1x 3255.
- ② 1x line adapter in the last bifurcation/plant, in "A". 1x 3255.

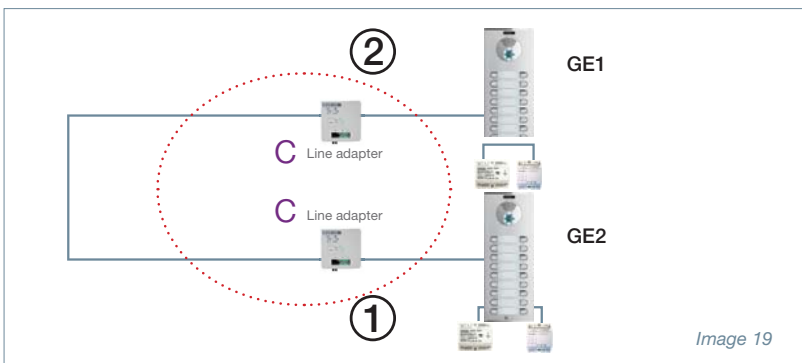

Image 19

Sections 2, 3, 4, 5 and 6 (interior blocks).

You need 2 adapters:

- ① - 1x line adapter in the first bifurcation/plant, in "C". 1x 3255.
- ② 1x line adapter in the last bifurcation/plant, in "A". 1x 3255.

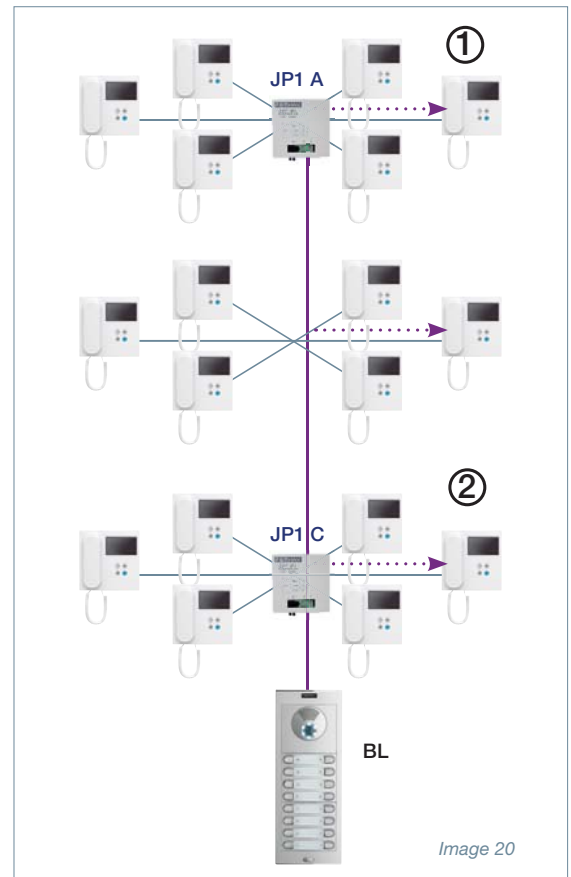

Image 20



DESIGN OF THE DUOX INSTALLATION

UNIT 4

CHECK HOW MANY POWER SETS ARE NECESSARY

Section 1

The GE1 panel (just like GE2) is 15m from its power set, made up of 1 unit. Filter DUOX Ref. 3244 and 1 unit. power source Ref. 4812. Both panels are correctly powered.

The regenerator Ref. 3259 at the entrance of each block will receive power from the source that is on the side of the interior blocks.

Sections 2, 3, 4, 5 and 6 (interior blocks).

Each block is composed of a total of 18 terminals; you need 1 power set, composed of a source Ref. 4812 and filter 3244, in each block.

You also must check that the voltage reaching the last terminals are correct. For this, check table 1 pg. 10.

In this installation the distance from the source to the last bifurcation/floor is 9m.

$$9m = 3m \text{ (distance set to 1st floor)} + 2 \times 3m \text{ (distance from the 1st floor to the 3rd)}$$

Since the distance is less than the maximum indicated in Table 1. pg.10. you can assume the installation diagram is correct, and make the materials list.

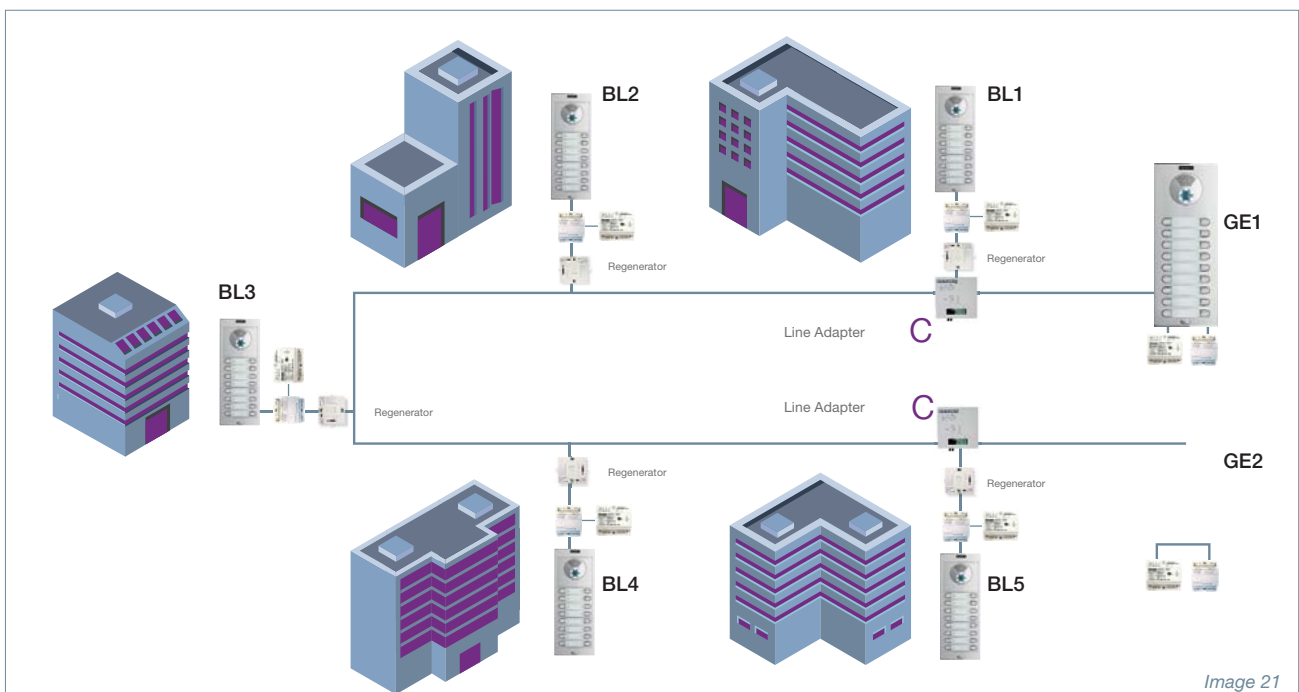

Once the installation design is finished, **we can make the materials list.**

FAQ

Can you use any source to power DUOX?

DUOX uses a 18Vdc source. This source must be FERMAX Ref. 4830 /4812/ 4810 (4830 of version 3.1 on and 4810 and 4812 of version 2 on).

Can you extend the panel distance-power set indicated in the tables with a power source of a greater amp?

No, while this distance can sometimes be extended using two regenerators.

See the "Use of the regenerator" section to extend panel-power set-first bifurcation distances on pag 21.

Can I use a source without a filter that powers only the panel, and another power set for the terminals? No.

If the building has 6 residences per floor, can I not use DUOX?

If there are more homes per distribution point, you can use a regenerator or separate the distribution points 3m, (that is, simulating a new floor), so that there are not more than 6 homes per point of distribution. Ask Fermax technical support.

If the building has more than 4 trunks, can I not use DUOX?

A basic DUOX installation includes up to 4 trunks, relative to the topology. If there are more trunks, you can add the regenerators required (together with the necessary power sets) to reduce the num. of trunks in the same section.

What distances do I have to have to make an installation DUOX?

Las que aparecen en los apartados de DESIGN OF THE DUOX BASIC INSTALLATION y Design of the Duox Advanced installation, según su caso.

Do I have to follow all maximum distances shown in the table_ What happens if we don't respect the indicated distances?

Yes If the system specifications are not met, it may not perform properly.

Do the indicated distances vary if the installation is only audio?

No, the indicated design distances are the same for audio, video or mixed installations.

Do you always need to install a 2S regenerator with a Power set?

The 2S regenerator needs a power source, but not necessarily the power adapter module.

Do you always need to install a 1S regenerator with a Power set?

Yes. The 1S and multichannel regenerator needs bus power, so it must have, at least on one side, a power set (source and filter)

Must the DUOX line adapters be placed in a specific point of the installation?

Yes. There are a set of rules that indicate where to install them and how to configure them. Install them or configure them differently than the general or specific rules may result in your installation not properly working or a terminal failing.

Does the type of cable use impact the system's performance?

Yes. The better the cable, greater distances and the more terminals/loads in the installations. The type of cable is a very important variable to keep in mind in the installation. We recommend using the Fermax cable Ref. 5925.

APPENDIX. *Technical Extension*

Compatible sources

Sources compatible with DUOX : 4810 and 4812 up to version 2.0.
4830 after version 3.1.

Street Panel

We recommend using a power source for the lock-release (if not using a distance panel-power set, it can be reduced 5 m).

If you use the entry panel keypad together with the directory panel, you must also use a dedicated power source.

DUOX shunts

It is worth further discussing the “shunt” concept: in DUOX we consider a riser in an installation as a shunt when the distance between the point of derivation and the first terminal is more than 20m.

DUOX line adapter

The concept of "Adapting the line" refers to the homogenization of impedance, that is, adapting the line is to adapt the line's impedance to keep it always the same.

If we maintain the impedance always the same, we avoid reflections. Reflections deform the DUOX signal and introduce noise and other types of problems in the installation.

The line adapter must have a third configuration B or not enabled.



DUOX by FERMAX

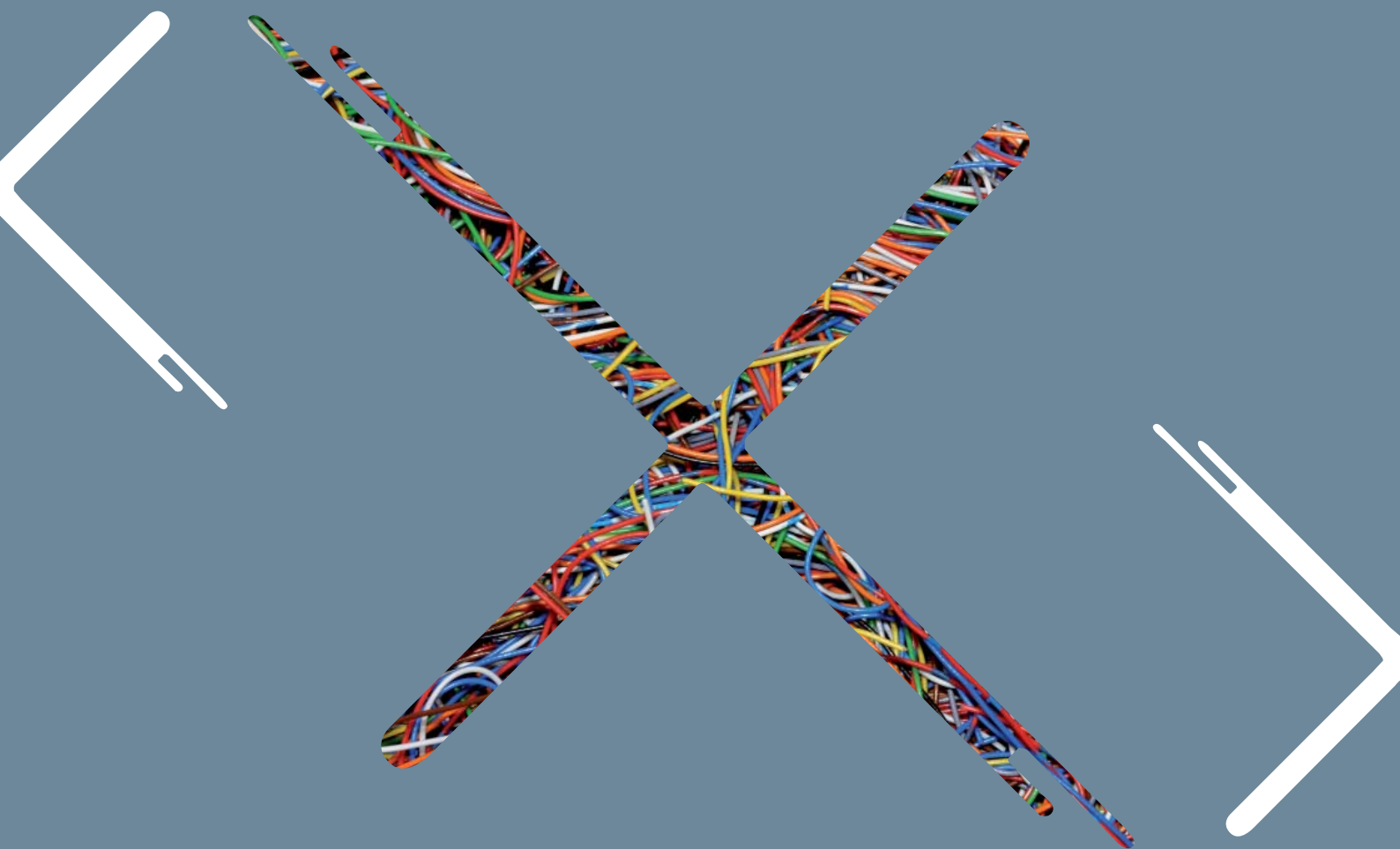

For more information: www.fermax.com

Contact: tec@fermax.com / www.fermax.com/contact