

GENERAL DESCRIPTION

The wireless input module allows the on/off status of an external device to be transmitted to the control panel via a translator module / expander module. Each module is intended to interface between a control panel and normally open contact devices. The connection between the module and the external device is supervised with the aid of an end of line resistor.

Communication between the input module and the translator / expander module(s) is wireless, via 'Wireless' bidirectional protocol.

PRODUCT OVERVIEW

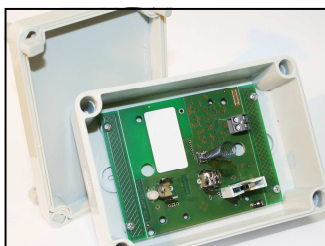

Picture 1 - General view of the FDWVM100

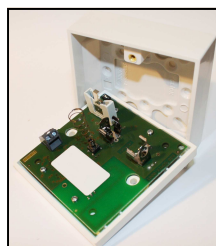

Picture 2 - General view of the FDWVM100-B

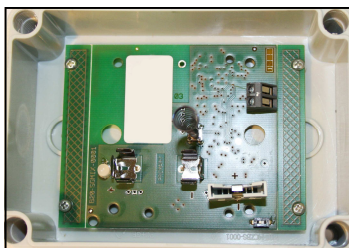

Picture 3 - The PCB of the FDWVM100

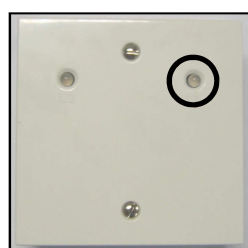

Picture 4 - The front of the FDWVM100-B and its LED

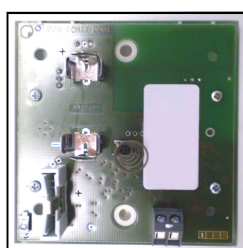

Picture 5 - The PCB of the FDWVM100-B

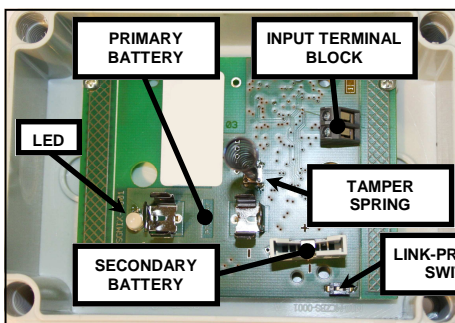

Picture 6 - The PCB of the FDWVM100 in detail

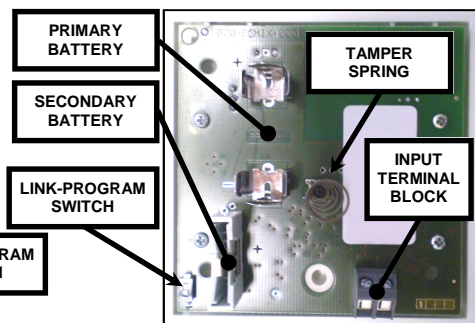

Picture 7 - The PCB of the FDWVM100-B in detail

MODULES VISUAL LED INDICATOR

The wireless input module is equipped with a bi-colour LED (red / green) that provides visual indication for functional conditions and battery levels as indicated in table 1. Both versions of the input modules have the LED positioned in different locations: refer to picture 4 and picture 6.

TECHNICAL SPECIFICATIONS

| | | |
|---|-----------------------|-----------------------|
| Communication range with the translator or the expander * | 200 m | In open space |
| Operating frequency | 868 MHz | |
| Modulation type | FSK | |
| Operating frequency channels | 7 | |
| Radiated power | 5 dBm (3 mW) | Typical |
| Transmission message period | 60 seconds | Default |
| Main battery ** / *** | Type CR123A | 6.5 years typical |
| Secondary battery ** / *** | Type CR2032A | 2 months typical |
| Ingress protection rating | IP 65 | Only for the FDWVM100 |
| Operating temperature range | From -30 °C to +55 °C | |

* Ideal operating range: may vary consistently according to environmental conditions.

** When a low battery condition is indicated, both, main and secondary, batteries must be changed altogether.

*** These lifespan values refer to the device being programmed with a control signals transmission period of 12 seconds.

DEVICE'S POWER SUPPLY AND LINKING

The linking operation permits the configuration of the wireless input module on the translator module. The linking operation described below does not change if made directly from the translator or from the PC configuration program.

- 1) Verify that the secondary battery is present; if not, insert the battery into its housing, referring to the polarities printed on the PCB.
- 2) Move the link-program switch to position ON.
- 3) Insert the main battery.

Ensure that both battery's polarities are correct.

The visual LED indicator switches green once, then four times red (programming mode) and will, successively, turn off. This indicates that the device is ready to be linked to the translator module.

- 4) Move the switch in position 1 to trigger the communication between the module and the translator.

The green LED switches on once, then it blinks many times (operating mode), and, finally, after alternating green-red for one second, the indicator turns off: this indicates that the linking procedure has been performed correctly and the device has programmed itself.

The input module is linked and all the parameters (address, system code etc.) necessary to work correctly are stored. If the LED remains switched on the red light it means that the linking operation failed. In this case remove the main battery, switch over alternatively the ON / 1 switch a few times in order to discharge the internal capacitor and then start again from point 2).

IMPORTANT NOTE! Programming is considered to be completed successfully only if there is an indication of programming success on the device and on the translator or on the window of the PC configuration program.

COMMUNICATION QUALITY ASSESSMENT

It is possible to assess the wireless communication quality of the module by using a testing feature built in the device. After a successful linking operation, by switching over the link-programming switch on the ON position, the module's indicator will start blinking according to table 2. **Always remember to reposition the switch to 1 after the assessment operation: device will NOT work operatively while the switch is positioned on the ON position.**

| Communication quality | Assessment | Device's indication |
|---|------------|---------------------|
| No connection | Fail | Two red blinks |
| Link margin is less than 10 dB | Poor | One red blink |
| Robust communication with link margin from 10 dB to 20 dB | Good | One green blink |
| Robust communication with link margin over 20 dB | Excellent | Two green blinks |

Table 2

| Device Status | Green LED | Red LED |
|-------------------------------------|---|--|
| Switching into operating mode | Short blinks | - |
| Switching into programming mode | - | 4 short blinks |
| Normal mode | - | - |
| Alarm condition | - | Blinking (0,5 second on / 1 second off) |
| Main battery fault (low level) | - | Blinking (0,1 second on / 5 seconds off) |
| Secondary battery fault (low level) | Blinking (0,1 second on / 5 seconds off) | - |
| Both batteries fault | Sequential bicolor blinking (0,1 second on / 5 seconds off) | |

Table 1

MODULE PLACEMENT

It is strongly advised to mount the device as far as possible from metal objects, metal doors, metal window openings, etc. as well as cable conductors, cables (especially from computers), otherwise the operating distance may greatly drop. The device should not be installed near electronic devices and computer equipment that can interfere with the reception's quality.

- 1) Select the position of the module before installing it. **Verify, from that position, that the communication between the device and the translator or the expander is correctly established and working (see the COMMUNICATION QUALITY ASSESSMENT paragraph).**
 - 2a) - **FDWVM100** - Install and fix the device's box in the selected position using the provided screws and their indicated lodgment holes (picture 8).
- The input module box is designed with 6 cable entry knockout holes, distributed on the lateral sides of the device's box, allowing sealed, gland fitted cables to be connected to the device and, at the same time, to preserve the original IP protection rating (picture 9).
- 3a) - **FDWVM100** - Fit the cable's gland (or glands) into the "knocked out" device box's cable entry.
 - 4a) - **FDWVM100** - Feed the cables into the box, giving them sufficient length for a secure connection.
 - 5a) - **FDWVM100** - Extract the supply batteries from their lodgment on the PCB, in order to power the device off.
 - 6a) - **FDWVM100** - Connect the cable's terminals to the device's input terminal blocks as indicated in the following paragraph.
 - 7a) - **FDWVM100** - Reinsert correctly the batteries into their PCB lodgments, in order to power up again the device.
 - 8a) - **FDWVM100** - Test the module, then install and screw securely the cover onto the module's box.
- 2b) - **FDWVM100 -B** - The input module box is designed with a set of breakable knock-out surfaces through which the cables from the external device can pass; so, knock out the surface (or surfaces) and let the cables pass through it (picture 10).
 - 3b) - **FDWVM100 -B** - Feed the cables into the box, giving them sufficient length for a secure connection.
 - 4b) - **FDWVM100 -B** - Extract the supply batteries from their lodgment on the PCB, in order to power the device off.
 - 5b) - **FDWVM100 -B** - Connect the cable's terminals to the device's input terminal blocks as indicated in the following paragraph.
 - 6b) - **FDWVM100 -B** - Reinsert correctly the batteries into their PCB lodgments, in order to power up again the device.
 - 7b) - **FDWVM100 -B** - Install and fix the device's box in the selected position using the provided screws and their indicated lodgment holes (picture 11).
 - 8b) - **FDWVM100 -B** - Test the module, then install and screw securely the cover with the PCB onto the module's box.

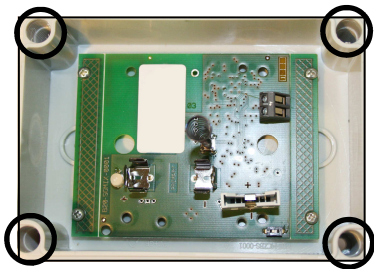

Picture 8 - Wall fixing screw entry points - FDWVM100

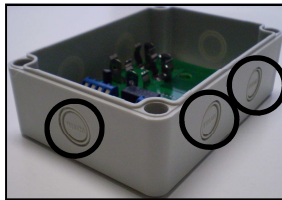

Picture 9 - Cable entry knockout holes - FDWVM100

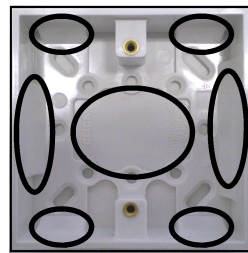

Picture 10 - Cable entry knockout surfaces - FDWVM100 -B

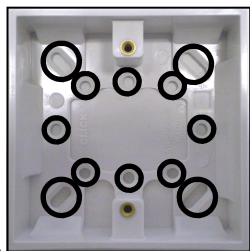

Picture 11 - Wall fixing screw entry points - FDWVM100 -B

| Resistors | Value | Note |
|-----------|--------------------------|--|
| R_{eol} | 5.6 kOhm (10% tolerance) | End of line resistor for the supervision of the line |
| R_{al} | 2.2 kOhm (10% tolerance) | Alarm resistor |

Table 3

WIRING CONNECTION

Following is illustrated the electrical scheme for the connection of the input module to the external device which transmits the input signal to the module (picture 12 and 13). End of line supervision resistor's and external device alarm resistor's specifications are reported in table 3.

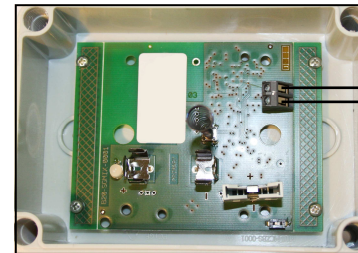

Picture 12 - Connection of the external device - FDWVM100

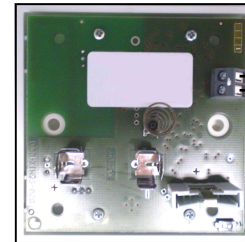

Picture 13 - Connection of the external device - FDWVM100 -B

TAMPER DETECTION FEATURE

The wireless input module is provided with a tamper detection switch-spring system, and, in case of removal of the cover from its box, it sends a tamper detection message to the control panel. For this reason assure that the front cover is well inserted and closed.

FAULT SELF-TEST

If a fault condition is detected by the input module, a fault message is sent to the control panel via translator / expander. The fault condition is locally signaled by the module's visual LED indicator (see table 1).

A fault condition is determined by:

- a) electronic fault
- b) low batteries level.

TESTING

In order to test the functionality of the installed input module the following test must be performed: activate the external device: the module must transmit the alarm message to the control panel via the translator / expander and switch on the LED indicator (blink red as per table 1).

After each test the module must be reset by the specific command on the control panel (see the RESET paragraph).

All devices must be tested after installation and, successively, on a periodic basis.

RESET

To reset the input module from alarm or fault condition it is necessary to send the reset command from the control panel: the LED indicator will be, as a consequence, turned off.

MAINTENANCE

- 1) Before starting any maintenance work, isolate and disable the system, in order to avoid accidental and unwanted fault / tamper detection conditions.
- 2) Remove the cover from its box.
- 3) Perform the planned necessary maintenance operations (e.g. changing the batteries).
- 4) After the device has been serviced, reinstall correctly its cover, re-apply power to the system and check correct operation as described under the TESTING paragraph.

WARNINGS AND LIMITATIONS

Our devices use high quality electronic components and plastic materials that are highly resistant to environmental deterioration. However, after 10 years of continuous operation, it is advisable to replace the devices in order to minimize the risk of reduced performance caused by external factors. Ensure that this device is only used with compatible control panels. Detection systems must be checked, serviced and maintained on a regular basis to confirm correct operation.

Smoke sensors may respond differently to various kinds of smoke particles, thus application advice should be sought for special risks. Sensors cannot respond correctly if barriers exist between them and the fire location and may be affected by special environmental conditions.

Refer to and follow national codes of practice and other internationally recognized fire engineering standards.

Appropriate risk assessment should be carried out initially to determine correct design criteria and updated periodically.

WARRANTY

All devices are supplied with the benefit of a limited 3 year warranty relating to faulty materials or manufacturing defects, effective from the production date indicated on each product.

This warranty is invalidated by mechanical or electrical damage caused in the field by incorrect handling or usage.

Product must be returned via your authorized supplier for repair or replacement together with full information on any problem identified.

Full details on our warranty and product's returns policy can be obtained upon request.

NORMATIVE COMPLIANCES

EN 54-18
EN 54-25