

NEO MEET

NEO MEET

**FERMAX**

INSTALLER MANUAL



**CONGRATULATIONS FOR BUYING A QUALITY PRODUCT!**

Fermax Electrónica develops and manufactures premium equipment that meets the highest design and technology standards. We hope you will enjoy all its functions.

---







*Technical publication for information purposes edited by FERMAX ELECTRÓNICA S.A.U.  
FERMAX ELECTRÓNICA applies a continuous improvement policy, therefore it reserves the right to modify the contents of this document, as well as the product features hereof at any time and without prior notice. Any modification will be reflected in subsequent editions of this document.*

*This product is protected with the following patents and utility models:*

*PATENTS: US 9215410, US 9762852, BE1023440, AU2014203706.*

*UTILITY MODELS: ES1187384U, ES1141495U, FR3038192, DE202016000632U1, CN205987229(U).*

# INDEX

|                                                                                     |                                                   |    |
|-------------------------------------------------------------------------------------|---------------------------------------------------|----|
|    | 1. DESCRIPTION                                    | 4  |
|    | 2. INSTALLATION                                   | 5  |
|                                                                                     | 2.1. Stand placement                              | 5  |
|                                                                                     | 2.2. Attaching the monitor to the stand           | 5  |
|                                                                                     | 2.3. Connection diagram                           | 6  |
|                                                                                     | 2.4. Wired alarm and doorbell sensors             | 6  |
|                                                                                     | 2.5. Wiring of FERMAX MEET Relay Module Ref. 1616 | 7  |
|    | 3. TECHNICAL SPECIFICATIONS                       | 8  |
|    | 4. LOCAL PROGRAMMING FROM THE MONITOR             | 9  |
|                                                                                     | 4.1. Installer access                             | 9  |
|                                                                                     | 4.2. Basic configuration of the MONITOR           | 10 |
|                                                                                     | 4.3. Configuring the alarm settings               | 11 |
|                                                                                     | 4.4. Enable/disable FUNCTIONS                     | 12 |
|                                                                                     | 4.5. Enable/disable function ICONS on the monitor | 13 |
|                                                                                     | 4.6. Change INSTALLER PIN                         | 14 |
|    | 5. WEB BROWSER PROGRAMMING                        | 15 |
|                                                                                     | 5.1. Device                                       | 16 |
|                                                                                     | 5.2. General                                      | 16 |
|                                                                                     | 5.3. Network configuration                        | 17 |
|                                                                                     | 5.4. Ip Camera                                    | 17 |
|                                                                                     | 5.5. SIP                                          | 18 |
|                                                                                     | 5.6. Advanced                                     | 19 |
|                                                                                     | 5.7. Actuators                                    | 20 |
|                                                                                     | 5.8. PIN Code                                     | 21 |
|                                                                                     | 5.9. Restore                                      | 21 |
|  | 6. ANNEX                                          | 22 |
|                                                                                     | 6.1. Firmware updates                             | 22 |
|  | 7. REGULATIONS AND CERTIFICATION                  | 23 |



# 1 DESCRIPTION

The following document is the Installation Manual for the NEO 7" MEET monitor, with firmware V03.00.

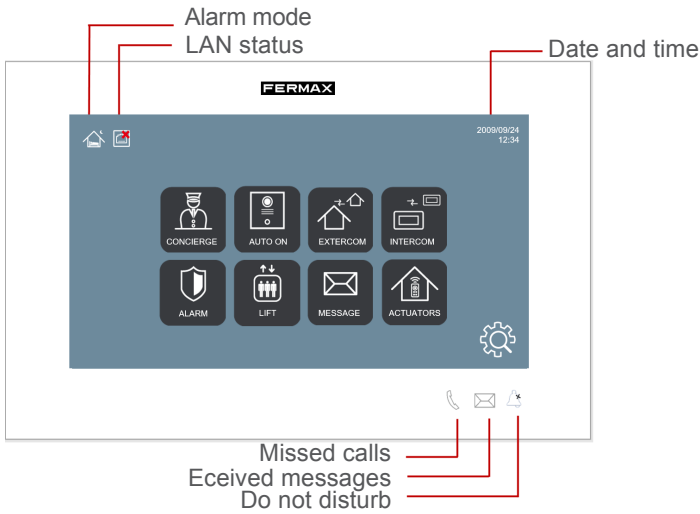



## 2 INSTALLATION

### 2.1. STAND PLACEMENT

Before installing the MEET monitor, the corresponding installation stand must be placed on the wall.

This stand must be screwed on covering the box or conduit where the cable or cables connecting to the monitor (ethernet cable, power supply and accessories, if any) arrive. Use the screws and plugs supplied with the monitor to attach the stand.

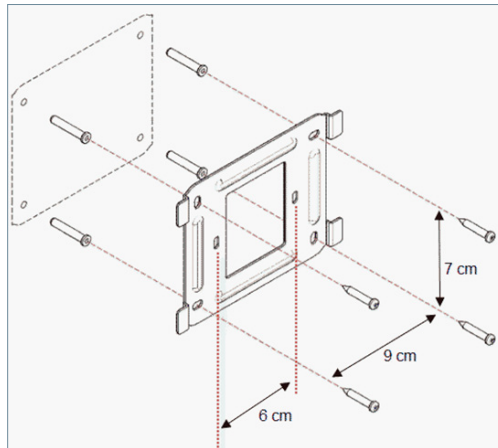

### 2.2. ATTACHING THE MONITOR TO THE STAND

Once the stand is in place, proceed to hang the monitor.

To do this, snap the 4 connector anchors into the corresponding slots on the back of the monitor and push down on the monitor to attach it.

Do not forget to pre-connect the ethernet network connectors, power supply and accessories, if applicable.

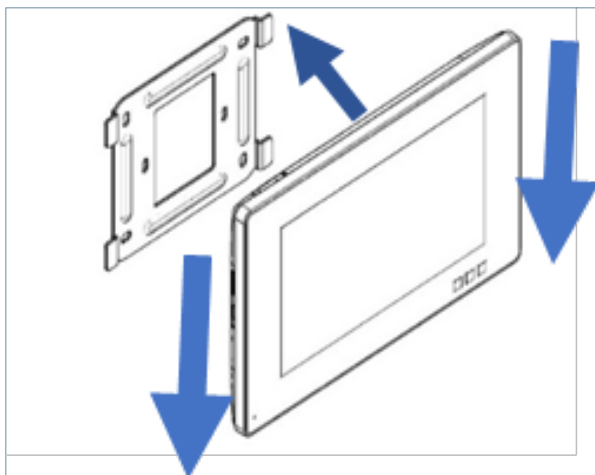

### 2.3. CONNECTION DIAGRAM

The MEET monitor are connected to the installation by means of connectors: ethernet for LAN connection and MOLEX type connectors for other connections (power supply, RS-485 and sensor inputs).

A bag containing the corresponding male connectors with their cables is enclosed with the wall connector Ref.9541

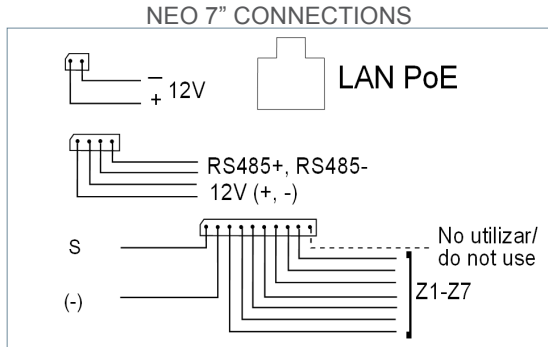

**LAN:** Ethernet connector to the building's LAN PoE installation.

**+12V:** 12 Vdc power input for non-PoE installations.

**Siren / Sensors:**

- o **S:** 12 Vdc auxiliary output synchronised with the activation of any sensor. The maximum current is 100 mA.
- o **-:** GND.
- o **Z1-Z7:** sensor inputs. (Z8 is already used for tamper alarm)

**12V +, -, 485+, 485-:** Salida alimentación y conexión RS-485 para el Módulo de 10 Relés Ref. 1616.

### 2.4. WIRED ALARM AND DOORBELL SENSORS

iring diagram, normally open sensor.

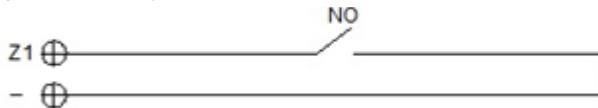

Wiring diagram, normally closed sensor.

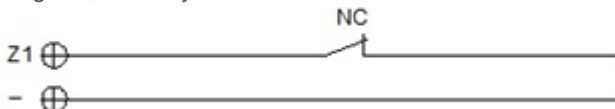

Wiring diagram, normally open sensor, option 3C.

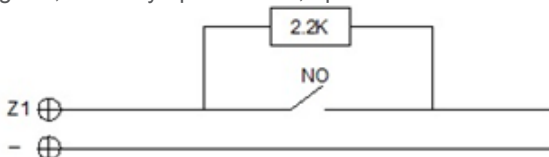

Wiring diagram, normally closed sensor, option 3C.

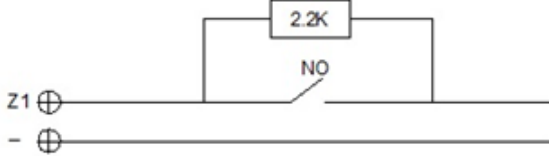

Wiring diagram, doorbell.

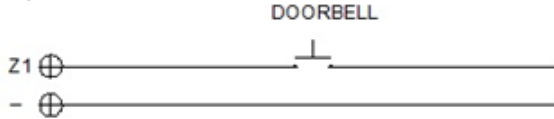

**NOTE:**

Option 3C consists of a monitoring system via which the monitor would detect sabotage in the sensor loop (shorting or cutting the sensor loop).

To enable this option, connect a 2.2KOhm resistor according to the diagram and enable the 3C function in the monitor (See section 4.3 Alarm settings). A bag with 8 resistors is included with the wall connector.

Triggering any sensor activates the S output for 5 minutes if the monitor has not been disarmed, except when configured as a doorbell.

The Z8 sensor input is reserved for the internal tamper (monitor anti-sabotage).

**2.5. WIRING OF FERMAX MEET RELAY MODULE REF. 1616**

To use the actuator control function, a FERMAX MEET Relay Decoder Ref. 1616 must be installed.

The connection to the monitor is through the RS-485 connector as shown in the following diagram.

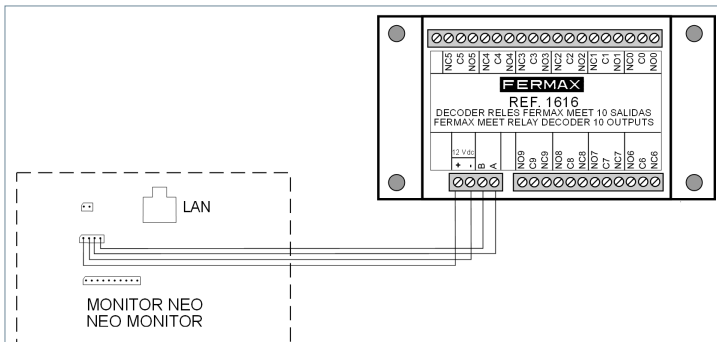

To activate the devices to be controlled, use the relay outputs 1 to 8, corresponding to the activations R1 to R8 of the monitor control screen. Relay outputs 0 and 9 are not used.

The module Ref. 1616 is powered directly from the monitor. No additional power is required.

The address of module has to be No.1 (this is the factory value).

**NOTES**

The module Ref. 1616 only activates the corresponding relay during the time indicated in the programming (between 1 and 60 seconds). After this time, the relay automatically returns to standby.

No relay status is displayed on the monitor.



## TECHNICAL SPECIFICATIONS

|                                     |                                                  |
|-------------------------------------|--------------------------------------------------|
| <b>Dimensions (mm)</b>              | 203 (Ancho) × 129 (Alto) ×<br>17.5 (Profundidad) |
| <b>Power supply</b>                 | 12 Vdc o PoE                                     |
| <b>Current</b>                      |                                                  |
| Idle current                        | 200 mA                                           |
| Working current                     | 500 mA                                           |
| <b>Resolution</b>                   | 800x480 pixels                                   |
| <b>Touch screen</b>                 | Tecnología capacitiva                            |
| <b>Tiempo máximo</b>                |                                                  |
| Conversation time                   | 120 secs.                                        |
| Time to answer the call             | 35 secs.                                         |
| Auto-on time                        | 30 secs.                                         |
| <b>Maximum recording log</b>        | 64                                               |
| <b>Maximum number of IP cameras</b> | 8                                                |
| <b>Block</b>                        | 001-999                                          |
| <b>Apartment</b>                    | 0001-9899                                        |
| <b>Working temperature</b>          | - 10°C ~ 55° C                                   |
| <b>Relative humidity</b>            | 20-85% (without condensation)                    |





## 4 LOCAL PROGRAMMING FROM THE MONITOR

MEET monitors allow the programming of basic configuration parameters (block identification, housing, IP address, etc.) through their own interface and without using a PC, so that it is possible to leave it ready to complete its configuration later via the web browser.

All MEET monitors have the same default IP address (10.1.1.1). In order to access them remotely via web browser, it is necessary to assign them a unique IP address, according to the requirements of the LAN.

It is therefore necessary to carry out prior planning of the installation, with the IP address to be assigned to each and every one of the components of the installation (monitors, panels and guard units).

### 4.1. INSTALLER ACCESS

From the idle screen, access the installer section by touching the icon .

Touch the icon  to access the programming parameters through the interface of the monitor itself.

Identify yourself by entering the INSTALLER PIN through the keypad:

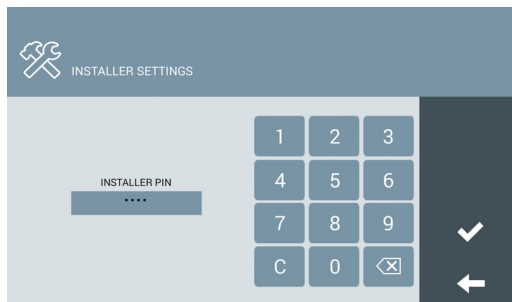

**The default INSTALLER PIN is 6666.**



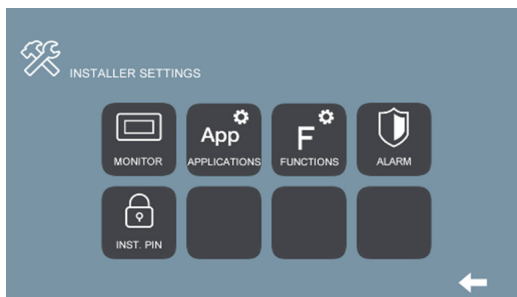

It can be changed later for another of your choice.

For security reasons, if the wrong PIN is entered three times in a row, the device will be blocked for 60 seconds.

Once the correct PIN has been entered, the INSTALLATION SETTINGS options will appear:



The options available from this section are:

|                                                                                   |                                                                                      |
|-----------------------------------------------------------------------------------|--------------------------------------------------------------------------------------|
|  | Basic monitor configuration (IP addressing, LAN configuration, block, housing, etc.) |
|  | Installation/desinstallation of ICON user functions.                                 |
|  | Enable/disable user functions.                                                       |
|  | Configuring the built-in alarm settings.                                             |
|  | Change the INSTALLER PIN code.                                                       |

## 4.2. BASIC CONFIGURATION OF THE MONITOR

Touch the icon  to access the basic configuration parameters:

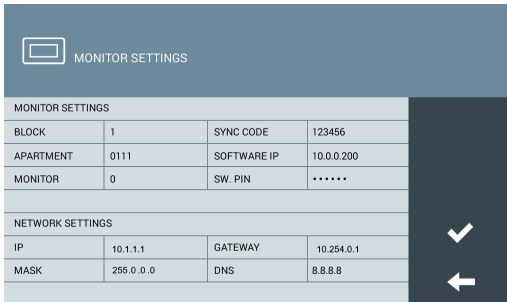

Use the keyboard that will appear on the screen to enter the corresponding programming parameters.

### MONITOR SETTINGS

- **BLOCK:** Block number of the apartment where the monitor is installed.
- **APARTMENT:** Number of the apartment where the monitor is installed.
- **MONITOR:** Number (from 0 to 9) assigned to each of the monitors installed in the same apartment, in the case that there are more than one. Otherwise, leave the default value "0".
- **SYNC CODE:** Synchronisation code with the rest of the devices in the apartment. Default value is 123456.
- **SOFTWARE IP:** IP address of the PC where the MEET Management Software is installed (if any).
- **SW PIN:** MEET Management Software ACCESS PIN code. The default option is 123456.

**NETWORK SETTINGS**

- **IP:** IP address to be assigned to this monitor.
- **MASK:** Subnet mask corresponding to the LAN.
- **GATEWAY:** LAN gateway.
- **DNS:** DNS server address of the LAN. In case of doubt, we recommend using the default value 8.8.8.8.

After all data has been entered correctly, a confirmation message “SETTINGS SAVED” will appear. Otherwise, re-enter the data correctly.

**NOTES:**

*Before programming the monitors, it is necessary to plan the installation with the following criteria:*

- Assign a unique IP to each element of the installation (including the PC where the MEET Management Software is installed, if any).
- All IP addresses must be in the same range.
- The LAN to be used must have an internet connection (if MEET ME call divert to mobile is required) and be correctly configured.

*Consult your LAN administrator if you have any questions regarding the configuration of network parameters.*

**4.3. ALARM SETTINGS**

Touch the icon  to access the configuration parameters of the Alarm Centre incorporated in the monitor, according to the installation carried out. (See section 2.4 **Wiring of alarm and doorbell sensors**).

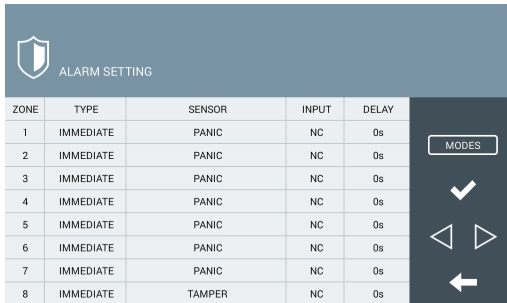

| ZONE | TYPE      | SENSOR | INPUT | DELAY |
|------|-----------|--------|-------|-------|
| 1    | IMMEDIATE | PANIC  | NC    | 0s    |
| 2    | IMMEDIATE | PANIC  | NC    | 0s    |
| 3    | IMMEDIATE | PANIC  | NC    | 0s    |
| 4    | IMMEDIATE | PANIC  | NC    | 0s    |
| 5    | IMMEDIATE | PANIC  | NC    | 0s    |
| 6    | IMMEDIATE | PANIC  | NC    | 0s    |
| 7    | IMMEDIATE | PANIC  | NC    | 0s    |
| 8    | IMMEDIATE | TAMPER | NC    | 0s    |

For each of the alarm zones indicate:

**TIPO:** Choose between INSTANT, DELAY or PANIC

- **INSTANT:** The alarm will be triggered at the same time as the corresponding sensor is activated. Alarm will sound even in the arming countdown.
- **DELAY:** The alarm is triggered at the same time as the corresponding sensor is activated but the monitor will not produce alarm sound after the indicated time, to give the user time to switch it off. Alarm will not be triggered during the arming countdown.
- **PANIC:** The alarm will be triggered silently, i.e. by giving a warning to the control station, but without alarm sound on the monitor.

**SENSOR:** Choose the type of sensor used in this area, between SMOKE, GAS, MOTION, DOOR, WINDOW, PANIC, TAMPER and SOS.

This is the information that will appear on the monitor screen after the corresponding alarm is triggered and sent to the GU and MEET Management Software.

**INPUT:** Choose between 3C, NO, NC or BELL.

- **3C:** If you have used the anti-tamper monitoring resistor in the sensor installation.
- **NO:** If a Normally Open type sensor has been used.
- **NC:** If a Normally Closed type sensor has been used.
- **BELL:** If this area has been used to install a doorbell button.

**DELAY:** If a DELAY type sensor has been selected, select the required delay time from the options offered (0, 5, 15, 20, 25, 40 or 60 seconds).

**MODES:** Select the MODES in which you want each of the zones to be active, according to the type of sensor and the installation carried out.

| ZONE | HOME                     | SLEEP                    | OUT                      |
|------|--------------------------|--------------------------|--------------------------|
| 1    | <input type="checkbox"/> | <input type="checkbox"/> | <input type="checkbox"/> |
| 2    | <input type="checkbox"/> | <input type="checkbox"/> | <input type="checkbox"/> |
| 3    | <input type="checkbox"/> | <input type="checkbox"/> | <input type="checkbox"/> |
| 4    | <input type="checkbox"/> | <input type="checkbox"/> | <input type="checkbox"/> |
| 5    | <input type="checkbox"/> | <input type="checkbox"/> | <input type="checkbox"/> |
| 6    | <input type="checkbox"/> | <input type="checkbox"/> | <input type="checkbox"/> |
| 7    | <input type="checkbox"/> | <input type="checkbox"/> | <input type="checkbox"/> |
| 8    | <input type="checkbox"/> | <input type="checkbox"/> | <input type="checkbox"/> |

**LOOP DETECT:** Select this box if you want the system to monitor the status of the sensors every time you select NIGHT or OUT from the HOME mode.

In the event that a sensor in the NIGHT or OUT zones is activated, the user will be warned by a message on the screen. It will not be possible to change the mode until the incident has been corrected.

*This makes it possible, for example, to avoid false alarms or security failures, if a door or window is left open at the time that SLEEP or OUT mode is selected.*

#### 4.4. ENABLE/DISABLE FUNCTIONS

Touch the icon  to select which functions are to be available to the user and which functions are to be blocked.

| FUNCTIONS       | STATUS                              |
|-----------------|-------------------------------------|
| EXTERCOM        | <input checked="" type="checkbox"/> |
| AUTO ON         | <input checked="" type="checkbox"/> |
| MESSAGE         | <input checked="" type="checkbox"/> |
| PICTURE CAPTURE | <input checked="" type="checkbox"/> |
| AUTHORIZATION   | <input checked="" type="checkbox"/> |
| UPSTAIRS        | <input checked="" type="checkbox"/> |
| DOWNSTAIRS      | <input checked="" type="checkbox"/> |

In the case of disabled functions, the corresponding icon will appear on the screen, but its use will be blocked, and a message will appear. "FUNCTION NOT ACTIVATED".

#### 4.5. ENABLE/DISABLE FUNCTION ICONS ON THE MONITOR

NEO monitor has some several function ICONS that can be displayed or not on the main user interface.

The ICONS by default are the following:

- **CONCIERGE**
- **AUTO ON**
- **EXTERCOM**
- **INTERCOM**
- **CALL LOG**
- **ALARM**
- **LIFT**
- **MESSAGE**
- **ACTUATORS**
- **SOS**

You can select up to 8 ICONS to be available in the monitor.

Touch the icon  to access function ICONS section. There are 2 pages, that can be selected by means of the "arrow" icons.

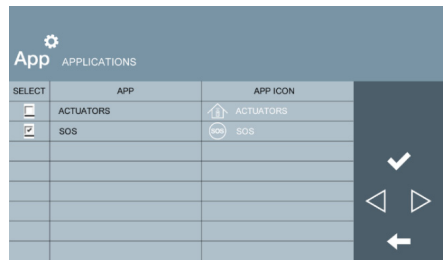
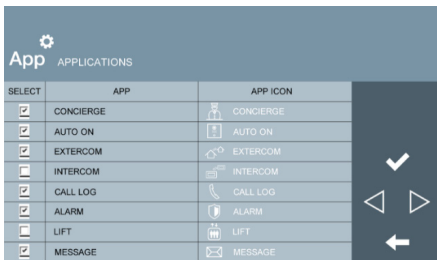

Select wich function ICON do you want be visible in the MAIN MENU. The MAIN MENU will show the 8 selected function ICONS.

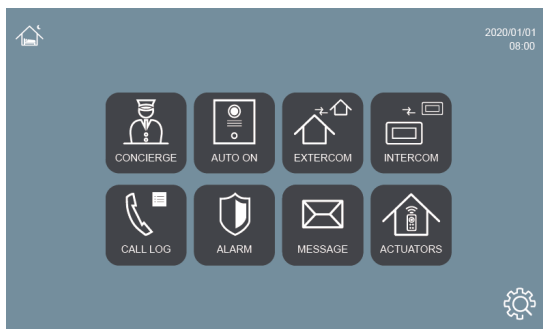

In the case of the selected function ICONS are less than 8 the rest will be blank.

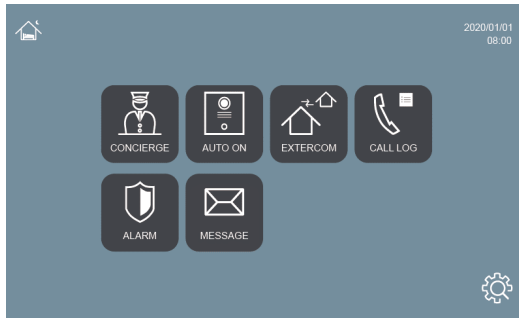

#### 4.6. CHANGE INSTALLER PIN

To access the INSTALLER MENU you must identify yourself using an INSTALLER PIN, which by default is 6666.

We advise you to change it for another of your choice. The new code must be 4 digits long. See **NOTES**

Touch the icon  to change the INSTALLER PIN.

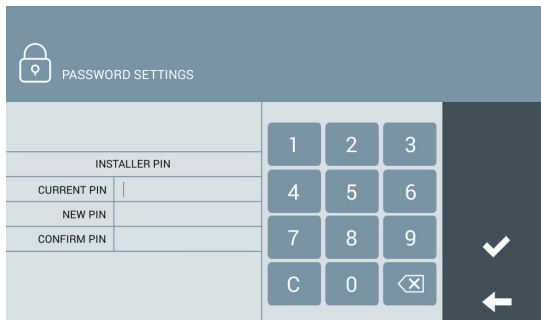

Use the numeric keypad to identify yourself with the current PIN and enter the new PIN. Confirmation of the new PIN is requested for security purposes.

#### NOTES

*If the INSTALLER PIN is changed via WEB browser it can be longer and contain alphanumeric characters (See section 5.8 PIN CODE). But in that case it cannot be used to access the configuration from the monitor itself.*

*Make a note of the new PIN at your convenience. If you lose or forget your PIN, you should contact FERMAX's Technical Department to receive instructions regarding its recovery. All the monitor programming will be lost.*



## WEB BROWSER PROGRAMMING

For complete programming of the MEET monitor, access is required through a PC via a web browser.

The PC must be connected to the same LAN as the monitor and configured with an IP address in the same range.

The MEET monitors' default IP address is 10.1.1.1. However, this address can also be changed or consulted via the local programming of the monitor. See section 4.2 Basic configuration of the MONITOR.

Type the IP address of the monitor in the address bar of the browser.

An identification form will appear.

Sign in

http://10.1.0.1

Your connection to this site is not private

Username

Password

The default identification data are:

- **Username:** admin
- **Password:** 6666

A form will appear with the different programming sections:

**FERMAX**

MEET VIDEO DOOR ENTRY SYSTEM

**DEVICE**

GENERAL

NETWORK

IP CAMERA

SIP

ADVANCED

ACTUATORS

PINCODE

RESTORE

DEVICE INFO

---

FERMAX NEO MONITOR  
 FIRMWARE: V03.00  
 DEVICE:001-0001-0  
 MAC:BC:F8:11:0A:30:DD  
 IP:10.1.1.1  
 COPYRIGHT © FERMAX ELECTRONICA S.A.U  
 www.fermax.com

SECCIONES DE PROGRAMACIÓN

**NOTES:**

*Preferably use the Chrome browser*

*The default identification data may have been changed from the local programming of the monitor.*

## 5.1. DEVICE

Provides some technical information regarding the equipment, as a reference.

The screenshot shows the FERMAX MEET VIDEO DOOR ENTRY SYSTEM interface. On the left is a vertical menu with options: DEVICE, GENERAL, NETWORK, IP CAMERA, SIP, ADVANCED, ACTUATORS, PINCODE, and RESTORE. The 'DEVICE' option is selected. The main content area is titled 'DEVICE INFO' and displays the following information: FERMAX NEO MONITOR, FIRMWARE: V03.00, DEVICE:001-0001-0, MAC:BC:F8:11:0A:30:DD, IP:10.1.1.1, and COPYRIGHT © FERMAX ELECTRONICA S.A.U www.fermax.com.

- **FIRMWARE:** Version of the installed firmware.
- **DEVICE:** Block, Apartment No., Monitor No.
- **MAC:** Monitor MAC number.
- **IP:** IP address assigned to the monitor.

## 5.2. GENERAL

Allows the configuration of the identification parameters of the monitor within the installation.

The screenshot shows the FERMAX MEET VIDEO DOOR ENTRY SYSTEM interface. On the left is a vertical menu with options: DEVICE, GENERAL, NETWORK, IP CAMERA, SIP, ADVANCED, ACTUATORS, PINCODE, and RESTORE. The 'GENERAL' option is selected. The main content area is titled 'GENERAL SETTINGS' and displays the following configuration fields: BLOCK (66), APARTMENT (1301), MONITOR (0), DEVICE TAG (LIVING ROOM), SYNC CODE (123456), NUMBER OF CONCIERGES (2), CONCIERGE 1 (9901, TAG: MANAGEMENT CENTER), CONCIERGE 2 (9902, TAG: EAST GATE), and a SAVE button.

- **BLOCK:** Block number of the apartment where the monitor is installed. 3 digits (001-009).
- **APART:** Number of the apartment where the monitor is installed. 4 digits (0001-9899).
- **MONITOR:** Number (from 0 to 9) assigned to each of the monitors installed in the same apartment, if there are several. If there is only one, leave the default value “0”.
- **DEVICE TAG:** Name that will be shown in the monitor when the function INTERCOM is being used.
- **SYNC CODE:** Synchronisation code with the rest of the monitors installed in the same apartment. It has to be the same in all of them. Default is 123456.
- **NUMBER OF CONCIERGES:** Choose between 0 and 9 the number of concierges that will be available for this monitor. Depending on the selected number, some additional fields, to identify the corresponding concierges will appear below.
- **CONCIERGE X:** Select the GU number to call.
- **TAG:** Name that will be shown in the monitor when a call to concierge is being made.



Enter the corresponding parameters and click **SAVE** to confirm.

**NOTE:**

*Before setting these parameters, it is necessary to plan the installation (installation project) in advance, considering the configuration of all the devices.*

### 5.3. NETWORK CONFIGURATION

Allows the configuration of the different parameters of the LAN network.



**IP:** IP address to be assigned to this monitor.

**MASK:** Subnet mask corresponding to the LAN

**GATEWAY:** LAN gateway

**DNS:** DNS server address. In case of doubt, we recommend using the default value 8.8.8.8.

**SOFTWARE IP:** IP address of the PC where the MEET Management Software is installed (if any).

**SOFTWARE PIN:** PIN ACCESS code used to access the MEET Management Software. The default setting is 123456. Indicate the corresponding parameters and click on **SAVE** to confirm.

**NOTE:**

*The MEET system uses static IP addressing. This ensures that each device has a unique IP address in the same installation.*

*If a monitor has an IP address already assigned to another device on the network, an “IP CONFLICT” prompt will appear, along with the MAC of the conflicting device.*

*Both devices will not work properly until this issue is resolved.*

### 5.4. IP CAMERA

Designate the IP camera or cameras, accessible on the NETWORK, that will be available for viewing on this monitor.

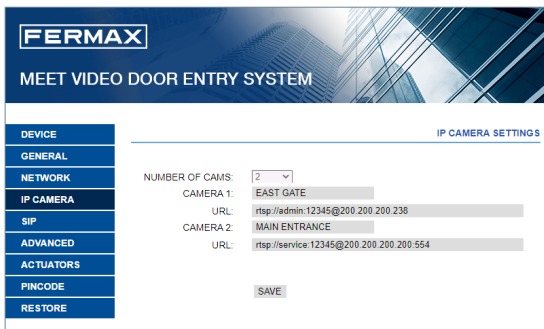

**Nº CÁMARAS:** Select the number of cameras to be designated, between 0 and 8. The form will be adapted to the number of selected cameras.

For each camera selected, indicate:

- o **CAMARA X:** Name that will appear on the monitors during the display of the camera, for better identification
- o **URL:** RTSP path of the selected camera.

**NOTE:**

The RTSP route generally has the following format:

**rtsp://user:password@camera\_IP\_address**

although it depends on the configuration, brand and model of the camera itself. Please refer to the corresponding data sheet or technical information.

### 5.5. SIP

Use this setting to configure the SIP monitor as a SIP protocol-based terminal in cases where the monitor is to be configured as an extension on a SIP server.

The available options are:

- **ENABLE:** Check this box if the SIP monitor is to be used as a SIP-based terminal.
  - SEARCH SIP STATUS:** This button appears when enable SIP function, show:
    - SIP REGISTERED** if the registers is successful or
    - SIP REGISTER FAILED** if the registers is unsuccessful.

- **SIP SERVER:** Enter the name or IP of the SIP server where the monitor will register.

- **DOMAIN:** Enter the domain of the SIP server

- **OUTBOUND, STUN IP:** Used for the configuration of installations where SIP server is on Internet. Check with your network administrator.

- **STUN PORT:** Used for the configuration of Internet SIP server-based installations. It is usually port 5060. Check with your network administrator.

- **USER:** Enter the SIP user name or extension to register on SIP server.

- **SIP PASS:** Enter the SIP server extension password.

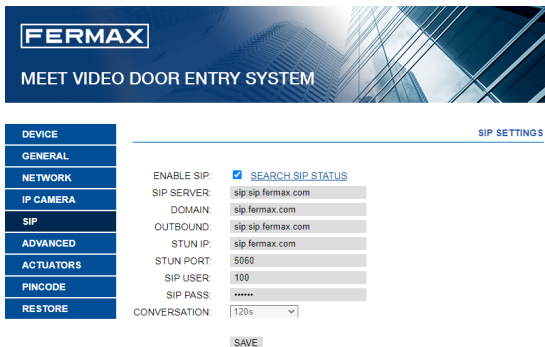

- **CONVERSATION:** Indicate the maximum conversation time in communications with SIP protocol.

**NOTE:**

The MEET monitor must be registered with the corresponding SIP server. Contact the server administrator for the necessary configuration data.

## 5.6. ADVANCED

The MEET monitors allow you to divert the calls to other devices such as:

- Smartphones (via MEET ME App)
- SIP devices

But the most common application is to divert the call to the MEET ME App.

**SIP EXT.:** Use this drop-down to set up call forwarding from this monitor to other devices (NONE, 1, 2, 3 or 4). The form will be automatically adapted depending on the number chosen.

Indicate the URL or URLs of the devices to which the calls will be forwarded. These URLs must have one of these formats:

- sip: meetme\_licensenummer@sip.fermax.com, in case of call divert to mobile using the MEET ME App, where meetme\_licensenummer corresponds to the MEET ME username on the sticker of the monitor and used to configure the MEET ME App on the smartphone.
- sip:XXX@ip\_address, in the case of forwarding to MEET monitors in the installation, where XXX is the device number and ip\_address is the IP address of that device.
- sip: extension@server\_sip, in case of forwarding to a third party SIP device registered into a SIP Server, where extension is the extension number of that SIP device and where server\_sip could be either the IP address of the SIP server or the domain name of the SIP server.

**DTMF UNLOCK:** Generally, panels using SIP protocol require a number or combination of DTMF numbers to activate the associated door opener.

Select this box if the MEET monitor is used in combination with a device that uses SIP protocol.

**DTMF KEY:** Indicate the DTMF number (or combination of numbers) to be generated when the monitor's door open button is pressed, to activate the calling SIP panel's door opener. They can be numeric characters and special characters such as # or \*.

**NUMBER OF DOORLOCKS:** Indicate the number of door openers that this monitor will control. (Between 0 and 4). Depending on the number indicated, the monitor screen will display additional door icons when you receive a call.

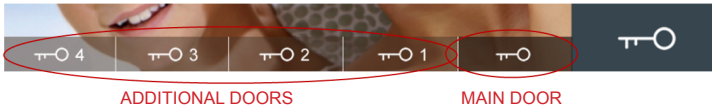

**NUMBER OF CAMERA:** Numbers of IP cameras related to the panel, that will be available to switch during panel call. (0-4 optional).

**NOTE:**

*Additional door openers are connected to a 4-Relay Meet Module Ref. 1491 connected to panel No.1 of the block where the monitor is installed (MILO DIGITAL, KIN or MARINE MEET panels only).*

### 5.7. ACTUATORS

Use this section to enable and name the actuators that this monitor can control.

| ENABLE                              | RELAY | DESCRIPTION         | RELAY TIME |
|-------------------------------------|-------|---------------------|------------|
| <input checked="" type="checkbox"/> | R1    | WATERING ACTIVATION | 1s         |
| <input checked="" type="checkbox"/> | R2    | STOP WATERING       | 1s         |
| <input checked="" type="checkbox"/> | R3    | VISITORS LIGHT      | 60s        |
| <input type="checkbox"/>            | R4    |                     | 1s         |
| <input type="checkbox"/>            | R5    |                     | 1s         |
| <input type="checkbox"/>            | R6    |                     | 1s         |
| <input type="checkbox"/>            | R7    |                     | 1s         |
| <input type="checkbox"/>            | R8    |                     | 1s         |

Click on ENABLE the relays to be enabled and write the name or description that should appear on the monitor when you want to control any of them.

Select the desired activation time with the RELAY TIME between 1 and 60 seconds.

Select SAVE to confirm.

**NOTE:**

*The control of devices by means of actuators requires the module Ref. 1616. Its installation is explained in section 2.5. Wiring of FERMAX MEET Relay Module Ref. 1616.*

### 5.8. PIN CODE

Allows you to change the INSTALLER PIN code, to access both the installation configuration parameters through the monitor’s own screen and the configuration through a web browser.



Enter the current code, the new pin and confirm it.

The new password can have alphanumeric characters and has no limitation on its length. However, if the password does not contain just 4 numerical digits it cannot be used from the monitor interface.

Finally, select SAVE.

**NOTES:**

*Make a note of the new PIN at your convenience. If you lose or forget your PIN, you should contact FERMAX’s Technical Department to receive instructions regarding its recovery. All settings programmed into the monitor will be lost.*

### 5.9. RESTORE

Use this functionality to remotely reboot the monitor, or to restore it to factory settings. In both cases it will ask for confirmation.

**RESTORE FACTORY SETTINGS:** The monitor will automatically turn off and start up with the factory settings:

**GENERAL**

- BLOCK: 1
- APARTMENT: 101
- MONITOR: 0

**NETWORK**

- IP: 10.1.1.1
- GATEWAY: 10.254.0.1
- MASK: 255.0.0.0
- INSTALLER PASSWORD: 6666



Any other parameters (sip, actuators, IP cameras, etc.) that have been configured will also be lost.

**REBOOT DEVICE:** The monitor will automatically turn off and start up but retain all the programming parameters it had previously.

When resetting, the device will lose connection with the PC. Refresh the website after about 60 seconds to resume the connection.

## 6.1. FIRMWARE UPDATES

Sometimes it may be necessary or convenient to update a new firmware version because improvements or corrections have been incorporated into its operation.

FERMAX's Technical Department periodically informs (through Communications, Technical Bulletins, etc.) about the release of a new firmware update, as well as the improvements incorporated.

Contact the FERMAX Technical Department if you wish to receive the corresponding update file.

The firmware update is performed via the **MEET System Upgraded Tool V 1.2.exe**. The procedure for updating the firmware with the corresponding update file is as follows.

It is possible to update several panels at the same time, selecting the range of the corresponding IP addresses (all of them have to be sequential).

### 1. Start the **MEET System Upgraded Tool V 1.2.exe**.

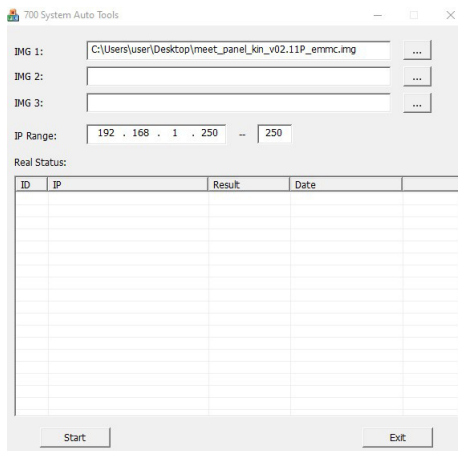

### 2. Click on “...” button and browse the PC to find the corresponding .IMG update file.

*Up to 3 .IMG files can be selected at the same time (for the case of the update has more than unique .IMG file).*

### 3. Indicate the IP Range of the panels.

### 4. Select Upgrade.

The new firmware will be installed, and the monitor will automatically restart.



## REGULATIONS AND CERTIFICATIONS

This equipment has been tested and found to comply with the limits for a Class B digital device, pursuant to Part 15 of the FCC Rules. These limits are designed to provide reasonable protection against harmful interference in a residential installation. This equipment generates, uses, and can radiate radio frequency energy, and if not installed and used in accordance with the instructions, may cause harmful interference to radio communications. However, there is no guarantee that interference will not occur in a particular installation. If this equipment does cause harmful interference to radio or television reception, which can be determined by turning the equipment off and on, the user is encouraged to try to correct the interference by one or more of the following measures:

- Reorient or relocate the receiving antenna.
- Increase the separation between the equipment and receiver.
- Connect the equipment into an outlet on a circuit different from that to which the receiver is connected. Consult the dealer or an experienced radio/TV technician for help.





Avd. Tres Cruces, 133  
46017 Valencia  
Spain

For more information, visit [www.fermax.com](http://www.fermax.com)

Contact: [tec@fermax.com](mailto:tec@fermax.com) / [www.fermax.com/contact](http://www.fermax.com/contact)